

Systems Engineering Tool for Intelligent Transportation

Help Manual

Version 9.3

Prepared by the

National ITS Architecture Team

Prepared for:

Intelligent Transportation Systems Joint Program Office (ITS JPO)

US Department of Transportation

Washington, DC 20590

December 2024

The logo for SET-IT, featuring the text "SET-IT" in a bold, green, sans-serif font. To the right of the text is a stylized graphic element consisting of several small, green, rectangular blocks arranged in a grid-like pattern, resembling a circuit board or a data matrix.

Table of Contents

Welcome to SET-IT Help.....	8
Support Services.....	8
End User License Agreement?.....	8
What's New.....	8
Enhancements.....	9
Bugs Fixed.....	9
Other Notes about This Version.....	9
Known Issues.....	10
Getting Started Using SET-IT.....	12
What Is SET-IT?.....	12
Considerations for This Version.....	13
Steps for First-Time Users.....	14
SET-IT Terminology.....	16
Starting SET-IT.....	24
Read Me.....	25
Projects in SET-IT.....	25
Create a New Project.....	26
Open an Existing Project.....	27
Converting from a Previous Version of SET-IT.....	28
Save a Project.....	34
File Notes.....	35
Read-Only Files.....	35
Language Support:.....	35
AutoBackup.....	35
Save your work often.....	36
SET-IT Crashed and I Forgot to Save!.....	36
Other Uses of the Temp Folder Window:.....	37
Close a Project.....	38
Print a Project.....	38
Export / Zip Up the Project Files.....	38
Access Help.....	39
Describe the Project.....	39
Project Information.....	40

Additional Information on the Overview Screen.....	40
Importing a Project from RAD-IT	41
Regional and Project ITS Architectures	42
Steps to Import a RAD-IT Project.....	42
Notes on Project Import from RAD-IT.....	48
Questions about Import.....	50
Select Service Packages	51
Model Systems Engineering (SE) Documents Service Packages.....	51
Service Package Selection Window	52
Service Package Implementations	53
Including Service Packages.....	54
Missing Service Packages	55
Searching for Service Packages.....	56
Open a Sample Project.....	57
Opening and Saving the Sample Project.....	57
More on the Sample Project	59
SET-IT Options.....	60
General Options	60
Diagrams Options.....	62
Requirements Options.....	65
Validation Options	66
Diagram Verification Options	67
Output Options	69
Event Log Options.....	70
Import Options.....	71
Advanced Options.....	71
AutoBackup Options	72
Searching My Project.....	74
Diagrams & Architecture Components	75
Common Usage Notes.....	75
Physical View	77
Including a Service Package	77
Create a New Physical Diagram.....	78
Add a Shape to a Diagram.....	79

Delete a Shape.....	81
Create an Element.....	81
Creating a Complex Element.....	87
Creating Communications Elements.....	87
Remote Access Device.....	88
Creating a Child or Instance of Another Element.....	88
Adding a Physical Object to a Diagram / Assigning Element.....	89
Adding a Physical Object Mapping.....	92
Removing a Physical Object Mapping.....	95
How Do I Customize an ITS Class Shape?.....	96
Shape Properties for Elements with Multiple Physical Objects.....	100
Create a New Information Flow.....	102
Identify Shape Properties of Flows.....	103
Flow Characteristics.....	106
Using FIPS.....	109
Create a New or User Defined Information Flow.....	113
Functional Objects on a Diagram.....	119
Add a Hyperlink.....	120
Can I draw my own Layer 2 diagram without an ARC-IT service package?.....	121
Diagram Clean-Up Tool.....	122
Diagram Completion Verification.....	124
Status of Multiple Shapes.....	127
Drawing Higher Layer Physical Diagrams.....	128
Layer 0/1 Settings.....	129
Layer 0 Specific Instructions.....	131
Layer 1 Specific Instructions.....	133
Enterprise View.....	138
Create a New Enterprise Diagram.....	140
SET-IT and Agreements.....	143
Add a Shape to a Diagram.....	144
Delete a Shape.....	146
Create a Stakeholder.....	146
Add an Enterprise / Stakeholder.....	148
Add a Resource.....	150

Add a Hyperlink.....	152
Creating a New Agreement	153
Creating a New Expectation	154
Creating a Role	155
Drawing a Member of relationship.....	157
Notes about Drawing Enterprise Diagrams.....	158
Communications View	159
Populating the Communications View	161
Using the Communications View Definitions Menu	166
Comm View Definitions Grid Features.....	175
Other Diagram and Architecture Tools.....	175
Creating New Items from the Ribbon	175
Creating a New Service Package	177
Creating a New Stakeholder.....	178
Creating a New Element	179
Creating a New Status Value.....	182
Creating a New Physical Object.....	183
Creating a New Functional Object.....	184
Creating a New Information Flow	185
Creating a New Requirement.....	187
Creating a New Physical Standard	188
Creating a New Need.....	188
Creating a New Agreement, Expectation, or Role.....	189
Creating a New Communications or Data Profile	190
Creating a New Standard	191
Creating a New Standard Bundle.....	197
Creating a New Solution.....	198
Add Comments or Notes to a Diagram.....	200
Add a Legend from SET-IT Stencil to a Diagram.....	201
Update a Physical Layer 0 or Layer 1 Diagram.....	202
Show Related Shapes.....	204
Update an Enterprise Layer 0 Diagram	204
Update the Diagram Title Block.....	205
Pan and Zoom a Diagram	206

Defining Scenarios	207
Defining Sequences	207
Clipboard	213
Editing/Adjusting Your Diagrams.....	214
Other Toolbar and SET-IT tools	217
Using Terminals.....	218
Adding Terminals.....	218
Going Further with Terminals	219
Using Data Distribution.....	219
Needs	222
Need Areas Definitions Grid.....	222
Needs Definition Grid	223
Requirements.....	225
Requirements Grid	226
Requirement Allocation Grid.....	229
Needs to Requirements Grid.....	230
Using the Left Menu.....	230
Overview Menu	231
Diagrams Menu.....	231
Definitions Menu	233
General Definitions Grid Features	235
Physical View Definitions	237
Enterprise View Definitions.....	244
Communications View Definitions.....	246
Review.....	248
Spell Check.....	248
Validation.....	249
Physical View Validation Checks	251
Enterprise View Validation Checks.....	252
Communications View Validation Checks.....	253
General Validation Checks	254
Validate Flows Tool	254
Outputs	256
Output Tables (Reports).....	256

Output Tables (Reports) Dialog Screen.....	256
Output Tables Options	258
Output Filter by Elements.....	258
Output Tables (Reports) – Current List of Reports	260
Output Documents	262
Concept of Operations Document Generation.....	262
Project Architecture Document Generation.....	271
System Requirements Specification (SyRS) Document Generation	275
Output Diagrams	278
Interface Diagrams	278
Context Diagrams.....	281
Communications Diagrams.....	283

Welcome to SET-IT Help

Version 9.3 - 12/2/2024

This provides help on the use of the **Systems Engineering Tool for Intelligent Transportation (SET-IT)** software tool. SET-IT is designed to integrate drawing and database tools with the Architecture Reference for Cooperative and Intelligent Transportation (ARC-IT). ARC-IT represents what was formerly known as the National ITS Architecture that merged with the content of the Connected Vehicle Reference Implementation Architecture (CVRIA) so that users can develop project architectures for pilots, test beds and early deployments.

Support Services

Our customer support team is standing by to offer friendly, responsive technical support to SET-IT users. You can contact customer support via phone or email. To receive the best support, please have the following information ready before contacting us:

- The version of SET-IT that you are using (and whether it's 32-bit or 64-bit),
 - Look at the splash screen when SET-IT opens or open the Project tab and select 'About' near the bottom of the navigation pane.
- The version and name of your operating system,
 - On the Windows desktop click the Start button (), select Computer, then select System Properties on the navigation ribbon near the top of the screen to see your system version and name information.
- A brief description of your problem or issue.

Telephone (U.S.): (800) 260-1001

Email: setit@iteris.com

End User License Agreement?

The SET-IT software is provided by USDOT without fee and in an "as is" condition. There is no End User License Agreement (EULA) or Terms of Service associated with the SET-IT software available from the ARC-IT website. Anyone interested in developing or maintaining a project architecture is allowed and encouraged to download the software and use it.

If you have further questions, please contact Cliff Heise at cdh@iteris.com or 703.623.6709. He is the Program Manager for the National ITS Architecture Program.

What's New

There are several new items to look for and consider in this version. Some are [Enhancements](#) or new features and others are [Bugs](#) that have been fixed since the last release. There are also some "[Other Notes](#)" to be aware of as you use this version.

Enhancements

With this release there are several new features as well as several problems fixed:

- Improved the user interface by greying out buttons after diagrams are generated so the user doesn't think that they may need to click it again.
- When assigning a flow name to a new horizontal line on a diagram the text will now be aligned such that it appears above the line instead of in the middle of the line.
- Users will be prevented from including an "&" (ampersand) character in the name of a diagram as it is a special character that can be misinterpreted by some software including other parts of the SET-IT software package.
- Substantial improvements in the time it takes to list the potential columns to include in an output table
- Improved line styles to better distinguish different status values
- Switched the version-check API to use HTTPS for enhanced security.

An updated Sample Project can be used to see how some of these new features look.

Bugs Fixed

This release corrects several issues with previous versions:

- Fixes an error that occurred when a user clicks the left side of the diagram and accidentally drags what Visio calls a Vertical line guide onto the diagram.
- Fixed errors when saving elements with special characters.
- Fixed errors when closing the Assumptions and Constraints window.
- Fixed issues with the Enterprise Diagram update that was improperly adding communication resources again.
- Fixed issues with conversion where some functional objects were not properly converted.

Other Notes about This Version

As with each version you can open and migrate projects that were created in previous versions of SET-IT. The "Conversion" process as it is called will go through and update your architecture so that it works with the current features of SET-IT. For example, older architectures may have included bidirectional information flows which are no longer supported. Conversion will tell you that you will need to separate those flows into 2 unidirectional flows. SET-IT will produce a report during conversion that lists objects that have been deprecated (no longer supported) and replaced in the new version. This report can be saved as a text file for analysis later on. Conversion now also detects flows that were routed through data distribution systems (DDS) and, in some cases will remove that routing because the rules for eligibility for routing information through a DDS may have changed. Conversion will also detect, and add as necessary, any mappings to the class level or level 1 physical objects (Center, Field, Personal, and Vehicle). These physical objects contain common functions and interfaces for any element created in that class. There is an option available that gives the user the ability to see or hide those class-level object mappings. The Conversion Report will list all of the changes made during the conversion process.

This version corrects a number of defects in the previous build related to saving files and installation.

NOTE: The development of SET-IT is an ongoing activity with new features being added periodically so an update is likely to be released every 8 weeks or so. At that time you will want to download and install the new version in order to get the most up-to-date features. Be sure you exit SET-IT and save your files before trying to uninstall SET-IT and install the update.

SET-IT no longer relies on the Microsoft Access Database Engine 2010. SET-IT will no longer install the Access Database Engine as part of the installation because Microsoft products now build those utilities in to their installed base. There are a few configurations of older Microsoft Office that may need the services of Access. In this case you may be directed to install Microsoft's Access Runtime product – this separate download from Microsoft's website will give your system the necessary utilities to support SET-IT.

- If you previously had a copy of SET-IT on your machine, then you may still have Microsoft Access Database Engine 2010 installed. SET-IT's installation will identify this and direct you to uninstall it. You will need to use your Control Panel to uninstall this Access Database Engine. Then you will also need to perform a Repair of your other Microsoft Office products and restart your machine. Once that's complete you can resume installing SET-IT.

Known Issues

There are a few issues based on different configurations or errors that happen on a sporadic basis that you may encounter.



- SET-IT can remain running in the background after the window has been closed. This seems to be due to an issue with recent updates to Microsoft Visio 365. The work-around is to open the Task Manager screen in Windows, find any instances of SET-IT and Microsoft Visio, and click "End Task". SET-IT can now be restarted. Some users have reported that they also need to restart their computer before they can restart SET-IT.
- Outputs created by the Interface Diagrams tool will sometimes show a flow that appears to go off the page. It is still connected to the right boxes – it's just routed in a strange way. The quick work-around is to simply move one of the boxes up and back down and the flow will properly reroute itself. They may also notice a performance hit when generating lots of diagrams at once. You can use the selection tools to divide up the outputs into batches to help with the resource usage.
- Access Database Engine (ADE) 2016 seems to be incompatible with Office 365 Pro Plus or other versions of Office that are considered "Click-to-Run". Users with this combination received SET-IT initialization errors. Users had to uninstall ADE 2016, perform a Repair of the Office products, and restart before SET-IT would work with Office 365.
- Users may get an error generating outputs to Word or Excel that refers to 'Interop' in the error message. If this happens the solution is to close SET-IT, go to the Control Panel and look for your Microsoft Office, click "Modify" or "Change" and select a "Quick Repair". Restart SET-IT and it should generate outputs again.

- If you are using a local area network-attached storage (NAS) system or a cloud-based service like OneDrive or Drop Box that try to synchronize your local files over a network, then you may get a message that you have a “Locked File Selected” and “The selected file appears to already be open in another application. Please close the other application so SET-IT has exclusive access to the file.” If this happens, you can still close SET-IT and your information is still stored. To avoid this message, go into the settings for the file sharing program, e.g., Drop Box or One Drive, and pause synchronization until you are done generating the tables, documents, diagrams, or web pages.
- Output Tables for agreements, expectations, and relationships may be blank if you try to generate outputs before generating an Enterprise Diagram. Populate the physical diagrams, including the selection of stakeholders and their roles, then generate the physical layer 0 and enterprise diagram in order for the output tables to be populated.
- Some users have reported an error message that occurs after they close or exit SET-IT. The error mentions an “Unknown software exception (0xc000000d)”. Clicking OK to the error message completes the exit process and no harm to any user data or to the computer configuration has been seen. This seems to be due to a conflict with Office/Visio 2016.
- Some users have reported a clipboard error when the certain diagrams or documents are begin generated or when a project is imported from RAD-IT. This happens when there are other programs running on the computer that are also trying to access the Microsoft Windows Clipboard. Steps have been taken to alleviate this but if this happens the best thing to do is delete the diagrams affected and regenerate the diagrams or redo the import. If it happens during Import you may see a screen suggesting that you Exit SET-IT without saving the imported project and start over. To try and prevent these errors it is best to try and not do anything else like Cut, Copy, or Paste on other programs while SET-IT is working on Import or diagram creation. One other workaround is to go into the Windows Settings for the Clipboard and make sure the Clipboard History setting is ‘Off’. This prevents the clipboard from keeping other things that may interfere with SET-IT during diagram/document generation or import.
- Some drawings when they are imported into SET-IT have boxes that show up with just a white box and no color to represent their class. Sometimes this may look like a box with extreme gradients in the coloring, with washed out white at the top and blue at the bottom. This appears to be a resource issue on the user’s computer. Delete the diagram and try again.
- A “System Resources Exceeded” error may occur when generating lots of diagrams or building a complex Layer 1 or Layer 0 diagram. Errors like this can lead to a catastrophic failure in the SET-IT database. SET-IT will prohibit future work on that database until the database is properly repaired. Once an error of this class is logged, any subsequent operation on the database should be prohibited and the user so notified. Upon any subsequent opening of the project the user will be notified that the database is corrupt and to choose a different file.

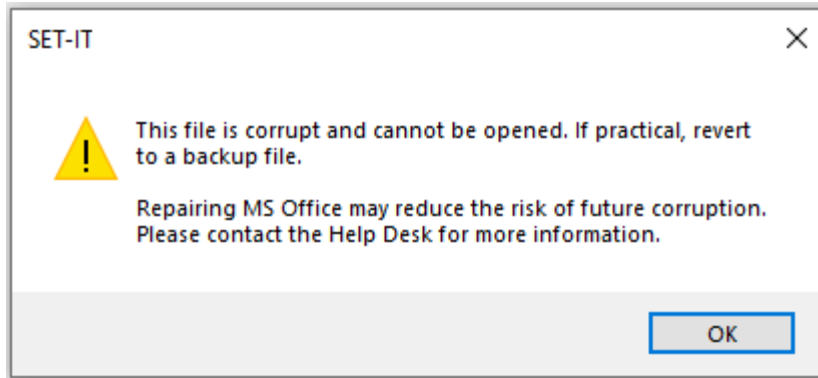

Notify the SET-IT Help Line if this occurs. You may have to use Task Manager to close SET-IT. As the warning message says, you may be able to reduce the risk of future file corruption issues by going to your system's Control Panel and performing a Repair of your Microsoft Office products, including Visio. Also, the usual caution to save your work and use the Export feature to periodically save of your project files into a separate zip file applies.

- Ctrl-drag copy does not work properly. Experienced Visio users may be accustomed to using Ctrl-drag to quickly copy a group of graphical elements. In SET-IT, that can have unintended consequences due to the need for SET-IT to maintain synchronization between the objects on the diagram and the database at all times. Users should just be aware when trying to use this feature.

Getting Started Using SET-IT

This section provides answers to basic questions like: What is SET-IT? What's in this version? How should you get started? What do all the terms used in SET-IT mean? What should I be aware of when I start SET-IT?

What Is SET-IT?

The **Systems Engineering Tool for Intelligent Transportation (SET-IT)** provides a single tool that integrates drawing and database tools with ARC-IT. ARC-IT represents what was formerly known as the National ITS Architecture merged with the content of the Connected Vehicle Reference Implementation Architecture (CVRIA). Users can develop project architectures for pilots, test beds and early deployments. This tool is based on Microsoft Visio for the drawings and Microsoft Access for the underlying data definitions.

The ARC-IT framework includes physical, functional, enterprise, and communications views for a wide range of ITS and connected vehicle applications, including Safety, Mobility, and Environmental applications as well as supporting services.

SET-IT users are encouraged to start by copying Service Package diagrams (by clicking Include) and customizing them to meet their own project needs. This way users can take advantage of a common set of drawings, objects, and interface definitions.

Considerations for This Version

This tool is provided as-is, with no implied warranty. While the development team will make every effort to maintain compatibility between versions, it is possible that a future version will not be 100% database compatible with this release. Please pardon the construction dust...

You can only run one copy of SET-IT on a machine at a time so if the installation script detects a version of SET-IT on your machine it will provide you the option of uninstalling that older version before installing the new version. Then, you can use the Convert feature to convert your older projects to match the schema and features of this new version.

In this version you can create *physical view*, *enterprise view*, and *communications view* architecture drawings using the same Visio template as ARC-IT.

SET-IT no longer supports Microsoft Visio 2010 – you must have 2013 or later and the version of Visio needs to match the version of the other Office products on your PC.

You can select/copy any of the ARC-IT service packages to use as starting points for your project. You can customize the physical object elements and flows descriptions. You can also generate outputs in the form of diagrams or tables that can be used in tools such as Microsoft Word or Excel.

NOTE: You can create Enterprise View Layer 0 drawings *after* you have created a Physical Layer 0. You can also use the Definitions grid to build a list of agreements based on the relationships between stakeholders that perform various roles with respect to the elements in the Physical View.

This version includes the ability to create a Concept of Operations (ConOps) document using either an ISO Standard 29148 template, a template used as a reference implementation in connected vehicle research projects, or a template used for Federal Highway Administration Model Systems Engineering Documents.

SET-IT imports the Needs and Requirements from ARC-IT for the Service Packages (application); you can include these needs and customize them for your project, or you can create a new set of needs for your project. You can also define Scenarios for a Service Package and define Sequences as an additional layer to the physical diagrams that will be used as part of the ConOps.

This version supports the Communications View by providing customizable solutions. The Communications View defines the layered sets of communications protocols that are required to support communications among the system elements that participate in the connected vehicle environment. SET-IT uses the templates and the information contained in the definitions tables that map the communications protocol standards to the element/flow triples selected in the physical view in order to generate the layered protocol diagrams for each interface.

This version includes a Sample Project that you can use in different ways – to see how a project is constructed or even to use to jump-start your own project. The Sample Project shows a mix of transportation and support Service Packages that many ITS and connected vehicle projects will need. You can start with the sample project file and customize it by adding your own Service Packages and drawings in addition to the Service Packages included in this sample project.

Steps for First-Time Users

This version includes a Sample Project that you can use to jump-start your own project. The Sample Project shows a mix of transportation and support Service Packages that many ITS and connected vehicle projects will need. You can start with the sample project file and customize it by adding your own Service Packages and drawings in addition to the Service Packages included in this sample project.

If this is your first time using this tool here are some practical steps to take to get started using the tool. There are additional help topics for each of these steps.

- 1) From the Project tab, start by creating a **New Project**
- 2) From this point you can use the **Service Packages** button to select one of the ARC-IT diagrams to *include* in your project. This will copy the physical diagrams as well as the needs and enterprise content defined in ARC-IT.
- 3) Use the Search box at the bottom of the list to search for an ARC-IT service package that includes a key word or phrase you are interested in.
- 4) If you want to start your own diagram, use the **Diagrams** button at the bottom of the left menu to start the Diagrams then click the Diagram button at the top and fill in the information to start a new diagram.
- 5) Use the diagrams tool bar and edit the **Shape Properties** of the objects and flows on the diagram.
- 6) Use the **stencil** to drag new shapes (physical and functional objects) and lines (information flows) onto the diagram.
 - a. Physical Objects: represent the major physical components of the transportation environment.
 - i. Elements – are local/customized instances of the ARC-IT physical objects.
 - ii. Physical Objects are shown on the diagram shapes (see the bottom of the Shape Properties window to see what Physical Object a shape represents) and can be related to Elements using the Details button on the Shape Properties.
 - iii. Physical Objects can include one or more functional objects if they are providing connected vehicle functionality.
 - b. Functional Objects: define more specifically the functionality and interfaces that are required to support a particular service package.
 - c. Information Flows: depict the exchange of information that occurs between Physical Objects and Functional Objects.
- 7) Double-click on each object and create a list or inventory of local/project-specific elements that represent the systems and device types that will be deployed or developed in your project or region. Associate the Elements with one or more physical objects on your diagram.

- 8) While still on the **Element Details** window enter **stakeholders** for who *owns* and who *manages* that element. These will be used later when you customize the Enterprise view and when you output the Stakeholders and the Relationship reports. You can also select roles like *maintains* for cases where one agency or company may be maintaining the components of a center that is owned by another entity. You can also use the *uses* role to show a case where a word like *uses* conveys more of the idea that a user is touching the controls of an interface like on a piece of Traveler Support Equipment located in an airport or mall.
- 9) Click on **Outputs** from the toolbar and export tables to be used in other publications.

Those steps will give you a basic physical view of a project architecture. You can go further by selecting the Enterprise View from the ribbon and customizing the stakeholders and their relationships, initially based on ARC-IT, and then generate Communications view protocol drawings for each interface that can be exported and included in your project documentation.

SET-IT Terminology

SET-IT and ARC-IT upon which SET-IT is based use some terms that may be unfamiliar to many users. Use this table and the ARC-IT website (www.arc-it.net) to learn more.

Application

Former term for a connected vehicle or ITS application from CVRIA describes the physical objects and interfaces, communications, functions, and enterprise relationships needed to provide a certain set of connected vehicle needs or requirements. See *Service Package*.

Architecture, Customized

A customized architecture is one in which element and information flow associations have been modified on the Diagrams tab in SET-IT. The flow status or other characteristics may be changed or the project association for a flow or element may be deselected.

Architecture, Uncustomized

An uncustomized architecture is one which has been built by including Service Packages from ARC-IT, including the prior Connected Vehicle Reference Implementation Architecture (CVRIA), via the "Service Packages" option on the Overview tab from the Home screen in SET-IT, but no changes to element or information flow selections have been made, i.e., no tailoring of the architecture has been done yet.

Center

Center is a term used in SET-IT and represents the primary Administration or Management "Element". This may often be a physical building (such as a Freeway Management Center) that includes one or more physical objects such as traffic management or transportation information functionality.

Coordination

In the Enterprise view, Coordination refers to the relationships that tie enterprise objects, or stakeholders, together. Formal coordination between Enterprise Objects is shown by red lines on an Enterprise Layer 0 diagram. This indicates that the parties involved enter into a formal *agreement*, where the nature of the relationship is documented by license, specification or other document. Informal coordination between Enterprise Objects is shown by blue lines on the Enterprise Layer 0 diagram. This indicates that the parties involved do not enter into any formal agreement, but nonetheless have some understanding of how the other party will act, either in terms of actions taken or data provided.

SET-IT will select relationships or points of coordination to include in the Coordination Report or on a generated Enterprise Layer 0 drawing by looking at the service package as well as other potential relationships that are defined among those same Enterprise Objects in other parts of ARC-IT.

Element

This is the basic building block of a local, regional or project architecture. It is the name used by the stakeholders to describe an instance of one or more connected vehicle/ ITS physical objects. An element is defined by the name that a user gives to an instance of the physical object (e.g., Caltrans/California Highway Patrol District 12 Traffic Management Center). [An element is also assigned to one or more stakeholders.]

Field

Field, a type of ARC-IT physical object and used in SET-IT represents the intelligent infrastructure distributed along the transportation network which performs surveillance, information provision, traffic control functions and whose operation is governed by a center object. Some field objects such as the Roadside Equipment (RSE) include the wireless communications to communicate directly with mobile devices, e.g., vehicles with onboard connected vehicle equipment.

Files

The definition of an architecture is saved in a set of files. A user's architecture will be saved by SET-IT in a set of files – a drawing file, a database, and a configuration file. Within these project files the user may define zero to many Service Packages.

FIPS

Federal Information Processing Standard (FIPS) Publication 199, Standard for Security Categorization of Federal Information and Information Systems, is used to characterize the flows of information into and out of a device in terms of its requirements for Confidentiality, Integrity, and Availability (C-I-A). This can be used on any service package physical diagram by selecting a flow and bringing up Shape Properties. From there you can select a check box to say "Using FIPS" and bring up the FIPS Details form to select from Low, Medium, or High for each of the Confidentiality, Integrity, and Availability settings and provide a rationale for your selection. Using this method is in lieu of using the Encryption and Authenticability values in Shape Properties. ARC-IT used this approach for its service packages and those are available in SET-IT to use as a starting point for your own projects.

NOTE: For flow lines on a diagram that have more than one flow name changing the FIPS basis and/or values will change information for all selected triples on that line. If you want to change FIPS information for individual triples, add another line to the drawing, assign the flow you want to change to that line and change the FIPS settings from there.

Functional Objects

Functional Objects, formerly known as Application objects or Equipment Packages are the smaller boxes within the physical objects on the drawings. They define the functionality that is required for each physical object to support one or more ITS Service Packages. Deployment status of a given Functional Object is indicated by its color; white (existing) light gray (included in project) and dark gray (future).

Hyperlink

An automatic link or reference to another location or file, perhaps to another location on the internet. In SET-IT you can create hyperlinks in order to add references or pointers to source material located on other websites or in other documents. You can use SET-IT to generate hyperlinks for Information Flows, Physical Objects, Functional Objects, and Resources that can be used as references in your output documentation.

Interfaces, Information Flows

Information flows define direction-specific information flow between ARC-IT physical objects and between elements of a Project Architecture – such as “road network conditions” from a traffic management center to an emergency center. Forms the basis for the standardization of interfaces.

Interfaces, Interconnect

Communications paths that carry information between physical objects of ARC-IT and between elements of a Project Architecture. P-Interconnects, or Physical Interconnects, appear on Layer 0 or 1 and contain all of the information flows between 2 physical objects.

Interoperability

The ability of two or more systems or components to exchange information and to use the information that has been exchanged.

Layers (Communications Diagrams)

Layers on a communications diagram refers to the abstract layers among communications protocols or partitions of functionality that are needed to achieve interoperability. These layered diagrams, also called protocol diagrams or profiles, show how each part of the communications ‘stack’ contributes to overall communications. The Communications View in SET-IT is based on the Communications View of ARC-IT. The layers and cross-cutting management and security planes of the ARC-IT Communications Model are described below:

- **ITS Application Entity:** The ITS application entity standards specify the structure, meaning, and exchange patterns of information between two end points.
- **Facilities Layer:** Facilities Layer Protocols define the rules and procedures for exchanging data, for representing the bits and bytes of information content to be transferred (e.g., encoding), and provide mechanisms for opening, closing, and managing a dialogue between ITS Applications. Sessions may be asynchronous as in paired requests and responses (information exchanges), asynchronous as in an unsolicited publication of information, and may require acknowledgement of receipt or not.
- **TransNet Layer:** TransNet (referring to the combination of Transport and Network) layer protocols define the rules and procedures for exchanging application data between endpoints as well as the routing, message disassembly/re-assembly and network management functions.
- **Access Layer:** Access Layer protocols define the rules and procedures for exchanging data between two adjacent devices over some communications media, as well as the signaling protocols that are typically developed for specific communications media.

- **Management Plane:** Management standards define the rules and procedures for controlling elements at all layers.
- **Security Plane:** The security plane identifies standards that specify policies and system-to-system authentication, and encryption of data across one or more layers of the communications stack.

See the [Communications Viewpoint Specification](#) page at the www.arc-it.net website for more information.

The Communications View tools allow you to view the standards assigned to each layer by ARC-IT or use the grid or diagram Shape Properties tool to assign standards to each layer, including the Security Plane. Validation tools can be used to help you find places where you may have put a security standard on a physical layer for internal communications or other inappropriate choices.

Each Communications View Diagram shows the information flow triple at the top and potential communications protocols in a layered stack that may be used for deployment.

Layers (Physical Diagrams)

One way to think of the physical view of a project is to think of it hierarchically where each *layer* in the hierarchy helps understand different aspects of the project. The layers can be briefly described as follows:

Layer 0 – high-level view showing all of the physical elements in a project and high-level links or “physical interconnects”, also called “P-Interconnects”, to show which elements are connected to each other and what type of communications may be required. There can be one or more Layer 0 drawings for each project. SET-IT will generate the Layer 0 drawings based on the Layer 2 drawings.

Layer 1 – adds the Functional objects that are inside each of the physical elements and uses the same P-Interconnects as on Layer 0. There can be one or more Layer 1 drawings for each project. SET-IT will generate the Layer 1 drawings based on the Layer 2 drawings.

Layer 2 – is based on each service package and includes all of the physical elements, the functional objects, and information flows for a single service package (formerly application) within the project. There will be as many Layer 2 diagrams as there are service packages for a project. Typically, Layer 2 will be the starting point as SET-IT provides the tools to Include or copy the ARC-IT service packages into your architecture.

Need

A specific goal or problem that the system, Service Package, or project is intended to achieve or solve. Sometimes referred to as a User Requirement as compared to a System Requirement.

Origin

See *Region*.

Personal

Personal, as a class of ARC-IT physical object and used in SET-IT, represents the equipment used by travelers to access transportation services pre-trip and en route. This was formerly known as the Traveler class. This includes equipment that are owned and operated by the traveler as well as equipment that are owned by transportation and information providers.

Physical Interconnect

Also known as P-Interconnects, these are thought of as the high-level communications paths or links that carry information between 2 *physical* objects on a Layer 0 or Layer 1 physical diagram. They contain all of the information flows between 2 objects.

Physical Object

A physical object represents a system or device defined in the ARC-IT physical view, or a user defined (locally defined) object. In SET-IT, each shape on a physical view drawing represents a physical object. Physical objects are grouped into five classes: Center, Field, Personal, Support, and Vehicle. Examples include Traffic Management Center (TMC), Vehicle Onboard Equipment (VOBE), and ITS Roadway Equipment, corresponding to traffic operations centers, equipped automobiles, and legacy ITS field equipment. Physical Objects are associated with Elements (local, customized versions of the physical object).

Profile

One of 143 combinations of standards that are each assigned to a data or communications protocol layer in order to support interoperable communications. Together data and communications profiles make up a communications solution. A data profile includes protocols at the ITS Information, Facilities, Management and/or Security layers. A communications profile includes protocols at the TransNet, Access, Management and/or Security layers. Sometimes both profiles in a solution contribute to Management or Security.

Project

A Project is a set of activities involving planning, development, integration and/or acquisition of systems/ technologies to deliver one or more ITS Service Packages as defined in ARC-IT. A Project typically has defined boundaries within the context of a Region.

Project Architecture

This term defines the elements and information exchanges of a single project that may include more than one Service Package / application.

Protocol Stack

An implementation of a communications suite or profile.

Readiness

An indication of the relative readiness of a communications solution for deployment. This applies to communication solutions that are assigned to information flow triples. The values for readiness shown on the SET-IT screens are calculated based on the issues or gaps that may exist for each of the communications layers for a given information flow. The more issues or the more severe the issues then the less 'ready' a solution is for deployment. A solution that has well defined standards for each layer of the communications protocol stack, including data and the communications profiles, as well as known and defined application specifications will be more ready for deployment than a solution for a new interface that has no or very little standardization. The values or scores for readiness are also aggregated for all of the flows in a given service package to give a sense of the overall readiness of that service.

Region

A region is a geographical area spanning one or more jurisdictions; its boundaries are defined locally and may or may not conform to existing political boundaries. A region could be a state or multiple states, a metropolitan area, or multiple metropolitan areas, one or more Metropolitan Planning Organizations (MPO), a corridor (e.g., I-95 corridor), counties, rural towns, or areas.

In SET-IT region may also refer to the region of the world over which a set of objects, flows, services, etc., applies. SET-IT provides several selections to choose from: Australia (AU), Canada (CA), European Union (EU), and the default, United States (US). Use the Project / Options screen to select or unselect the regions or origins. This setting will affect the objects, flows, solutions, etc., that are shown on the diagrams and tables.

Relationship

In the enterprise view, physical objects or elements from the physical view appear as *resources* in the enterprise view. In addition to the Roles that enterprises objects play with respect to the physical objects, enterprise objects can have *relationships* with each other. In ARC-IT and in SET-IT these Relationships may include agreements or expectations.

Roles

Enterprises or stakeholders can have certain *roles* with their physical objects or elements which requires them to interact in some way. For instance, enterprises like stakeholders have a relationship with physical objects or elements in which one *owns* or *manages* an element.

Scenario

In a Concept of Operations, a scenario is used to describe how the system will be operated under various conditions. For example, incident management scenarios will include normal monitoring, the sequence of events following an incident, and response to failure [e.g., sensors or communications]. In other service packages you might want to describe a 'sunny day' scenario and contrast that with the activities that take place in a 'rainy day' scenario. These scenarios will describe the activities from the viewpoint of each of the participants.

Sequence

A series of steps or events that happen as part of a scenario. This can be expressed as a sequence of flows sent back and forth on a physical view diagram. Or simply 'tagging' the system elements in the order in which they participate in the sequence.

Service Package

The physical objects and interfaces, communications, functions, and enterprise relationships needed to provide a certain set of transportation needs or requirements. The service packages collect together one or more "functional objects" that must work together to deliver a given transportation service and the "information flows" that connect them and other important external systems/objects. They identify the pieces of the physical view that are required to implement a particular service.

ARC-IT has eight types of service packages:

- Environmental
- Mobility
- Safety
- Support
- Convenience
- Informational
- Management
- Regulatory

Including ARC-IT Service Packages into a SET-IT project file allows a user to have a starting point to customize their own project's services.

Service Package Implementation

Many Service Packages include more than one way to provide a service. Service Package Implementations reflect a subset of the physical and functional objects that participate in an alternative implementation along with the information flows they exchange. The Service Package Implementation diagrams will distinguish which components are fundamental, or necessary, to that particular implementation from those that are optional or that have a "must have at least one" type of relationship. The Service Package Implementation provides users a short cut to defining a particular set of objects and interfaces for their project.

Service Package Instance

A Service Package Instance is the local, customized version of an ITS application or service that you have decided to include as part of your project. It can be based on a service package from ARC-IT or one that you defined yourself. Each instance includes the physical and enterprise drawings as well as the needs and requirements for that service package. Using service package instances allows architectures to include more than one approach to doing certain activities like traffic signal priority in a region with multiple jurisdictions.

Solution

A communications solution is the collection of standards and specifications that together satisfy the interface. Implementing a given solution means implementing the protocols noted inside the physical object that provides the ITS Application. In many cases there will be other devices in between the endpoints (routers, gateway, etc.) that are not the subject of this model. The ARC-IT Communications Model defines a communications solution as the combination of a data profile and a communications profile. A data profile includes protocols at the ITS Information, Facilities, Management and/or Security layers. A communications profile includes protocols at the TransNet, Access, Management and/or Security layers. Sometimes both profiles in a solution contribute to Management or Security. In SET-IT a triple is assigned to the solution with the highest level of readiness that is based on the standards, profiles, solutions with the fewest or least severe gaps or issues. The communications and data profiles reflect likely implementation choices and have been developed and assigned, where applicable, to triples. Other choices might be made in specific instances, which is why SET-IT provides the flexibility to manually adjust the assignment of solutions to triples.

Stakeholder

A stakeholder defines an organization that owns, manages, or interacts in some way with the elements in a project. When multiple stakeholders are involved, there are relationships between them that appear on the Enterprise view of an architecture. Stakeholders can also be grouped together for joint or combined roles.

Standards

Documented technical specifications sponsored by a Standards Development Organization (SDO) to be used consistently as rules, guidelines, or definitions of characteristics for the interchange of data. A broad array of transportation system standards and communications standards will be identified on the communications diagrams.

Support

Support, a class of ARC-IT physical object and used in SET-IT, represents the computer systems required to 'support' the transportation related services and applications. These may include security, data warehousing, network administration, and system monitoring or management systems.

System

A system is a collection of hardware, software, data, processes, and people that work together to achieve a common goal (definition from the National Highway Institute's System Engineering Course). NOTE that "system" is a relative term since many different types of systems fit this definition. To a sign manufacturer, a dynamic message sign is a "system". To a state DOT, the same sign is only a component of a larger Freeway Management System. In SET-IT, a Freeway Management Center System may be a part of the overall surface transportation system for a region.

Terminal

Terminals are small, rounded rectangles with an abbreviation that appear on some ARC-IT or SET-IT physical diagrams to represent another physical object on that same diagram.

Terminators

Terminators are physical objects that lie on the outside boundary of an architecture. These physical objects represent the people, systems, and general environment that interface with the physical objects known as subsystems that are inside the boundary of an architecture. The interfaces between terminators and the physical objects and functions within ARC-IT are defined, but no functional objects or functional requirements are allocated to them. The human operators, including drivers, are shown as physical objects with an icon of a person in the corner of the box. Human operators are also stakeholders so as you create and edit a Human Operator on the physical diagram you are creating and editing an element and a stakeholder at the same time if you leave the stakeholder's name blank as you create the element.

Triple

Defined by three things: the source, destination, and the information flow between them. This "triple" represents a particular instance of an information flow from ARC-IT. For example, the information flow, "incident information", goes between many ITS objects so the instance of incident management that goes from the TMC to the Emergency Management Center would be a 'triple'.

Vehicle

Vehicle, as a class of ARC-IT physical object and used in SET-IT, represents the general driver information and safety systems applicable to all vehicle types. Four fleet vehicle subsystems (Transit, Emergency, Commercial and Maintenance and Construction Vehicles) add ITS capabilities unique to these special vehicle types.

Views

The Architecture Reference for Cooperative & Intelligent Transportation (ARC-IT) is defined in a series of Views where each view provides a different perspective to understand the architecture and to address certain stakeholder concerns.

- **Enterprise:** relationships between organizations
- **Functional:** decomposition of system functions and their interactions (not covered in SET-IT)
- **Physical:** connections between physical objects and their functional objects
- **Communications:** layered communications protocols between physical objects

Starting SET-IT

As you click to start SET-IT or double-click on a .setit file SET-IT will start and a 'splash' screen will indicate what version of SET-IT is starting.

SET-IT will verify that you have the right version of SET-IT for your version of Visio. It will warn you if you are trying to run 32-bit SET-IT with 64-bit Visio or 64-bit SET-IT with 32-bit Visio.

Depending on your settings on the Options menu, SET-IT will also check to see if there are any updates available from the ARC-IT website. You may see a notification in the bottom right corner of the SET-IT window saying, either "SET-IT up to date" or "Update available!" It may also say "Version check failed" if you are not connected to the internet or if the verification server is not available for some reason. Use the Options menu to check manually.

Read Me

A README file comes with each version of SET-IT and is available from several places:

- As a text box within the About screen that is part of the Project menu
- As a text file that can be opened independently of running SET-IT. Click the Windows Start button and scroll down to "I" for ITS Architecture and select the SET-IT Read Me file.

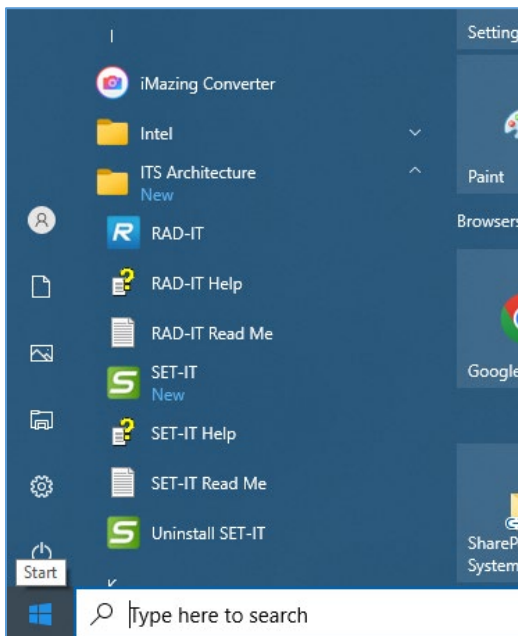

- From the ARC-IT website - <https://www.arc-it.net/tools/setitreadme.txt>

Projects in SET-IT

This section describes the operations and steps to follow in order to create, save, and modify an ITS project architecture using SET-IT.

Using the steps in this section you will see how to:

- Create a project architecture
- Open an existing project architecture
- Convert an older project architecture from a previous version of SET-IT
- Save a project architecture
- Close a project architecture
- Print the information about the project
- Export or Zip Up the project's files

SET-IT Help

- Describe the project architecture
- Import a project architecture from RAD-IT
- Select Service Packages that are included in the project architecture

Other features of the Project Menu include:

- Help menus – see the *"Access Help"* section
- Sample Project – see the *"Open a Sample Project"* section
- Options – see the *"SET-IT Options"* section
- About – to see what version this copy is running and the Read Me text

Create a New Project

To create a new project using SET-IT:

1. Select **Project** tab at the top of the menu,
2. Click **New**.
3. This will open the **Create New Project**, box
4. Enter the name of the new project in the **Project Name** text entry field
5. The **Project Location** field shows the default location where the new project file will be stored. Click **OK** if the location shown is acceptable. To store the new project's files in a different location, click the **Browse** button and select the location desired.
6. Click **OK**.

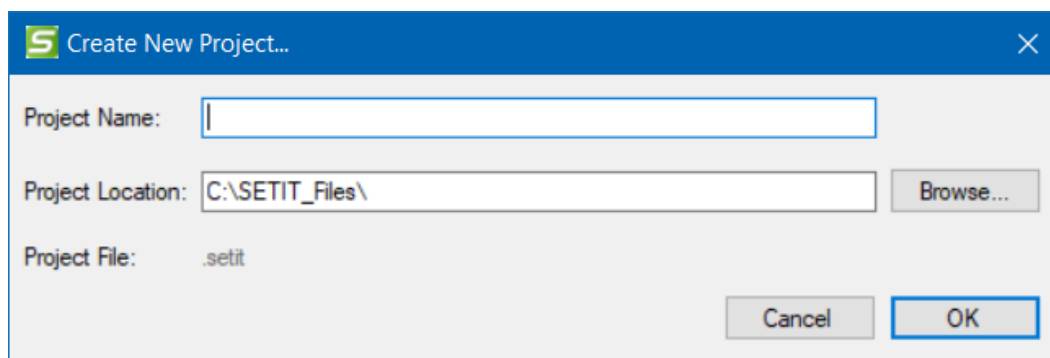
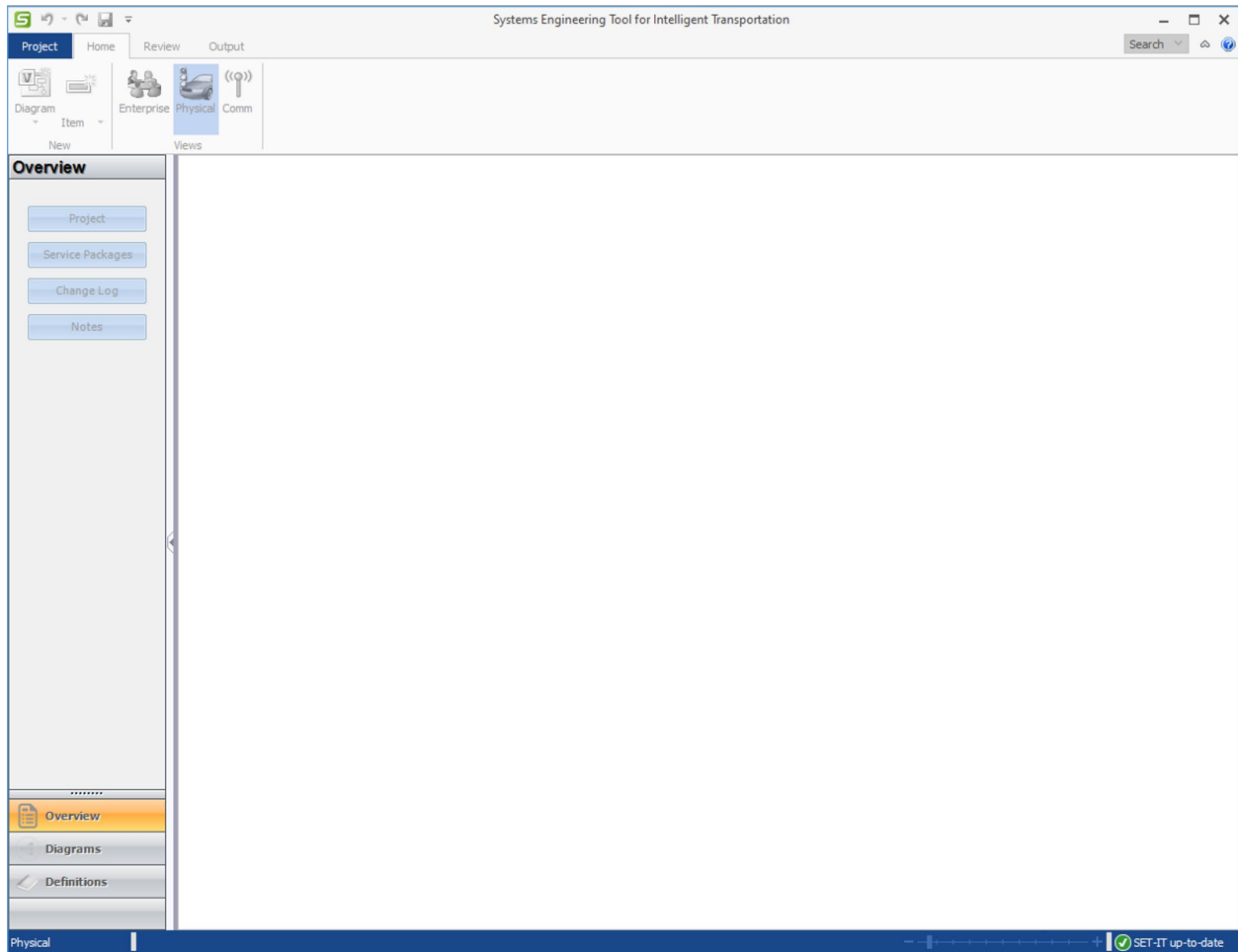

Open an Existing Project

To open an existing SET-IT project:

1. Select **Project** on the top menu,
2. Select a **Recent Project** from the list on the right or,
3. Click **Open**,
4. On the browser box identify the location of the existing project to open the file,

5. Click **OK**.

Project / Open will look at the folder that you last used to open or save a project file. If you haven't done that yet it will look at your [Options](#) settings in case you designated another default folder. Otherwise, it will start at the default folder for your machine, usually "My Documents."

Alternatively, you can open an existing project by using Windows Explorer to find the folder containing the project files and double-clicking on the .setit file. This will launch SET-IT and open the files for that project.

As the project is opened, SET-IT will ask if you would like to run a set of Validation reports on this project. This may be a good idea if you weren't the one that developed it or you haven't worked with it in a while. You can turn this option off using the Options menu.

SET-IT locks the files so you can't have a conflict where one application writes data that the other application is also editing. If you try to open a file that is already open, you will get a warning message that the file is in use by another program and to close the other program and try again.

Converting from a Previous Version of SET-IT

If you open a file that was created using a previous version, you will be warned that the data will be changed and will no longer be compatible with the previous version.

Upgrading or Converting allows you to preserve your prior work while taking advantage of the latest ARC-IT definitions – new Physical Objects, new Service Packages, new Communications Profiles, etc.

Before converting such a project save a copy to use in case you need to open it again in the older version.

SET-IT's conversion routines will then copy the project data into the latest data schema. Sometimes it will find issues where things are no longer supported, or they are supported differently. When it tries to map the components from the older architecture to match objects and flows of the new version there may be cases where more than one option exists, e.g., an older service package may now be represented as 2 service packages. In that case, SET-IT will default to choose the first service package. If that happens it will let you know in case you want a different choice.

In ARC-IT version 9.0 the Parking Management System physical object was split into 2 objects – a field-class Parking Area Equipment object and a center-class Parking Management Center. During Conversion if there was a Parking Management System element it will be mapped to both the new physical objects. Afterward, you may decide that you need another element or that your element is more related to one versus the other object and so you can adjust your mappings after conversion.

SET-IT will also align the characteristics of flows to match the ARC-IT definitions and characteristics. That may mean creating user defined versions of those flows if they had been changed or edited by the user in the previous version. After conversion you may notice multiple copies of some flows if

they had characteristics that differed from the ARC-IT base flows. You may want to keep the project unique versions or go back and manually select the ARC-IT flow to get the current characteristics from the reference architecture. It will be the one without a number on the end.

SET-IT changed how certain diagrams are defined so the conversion process will ask if you would like to save the old diagrams as Deprecated Diagrams in a separate Visio file.

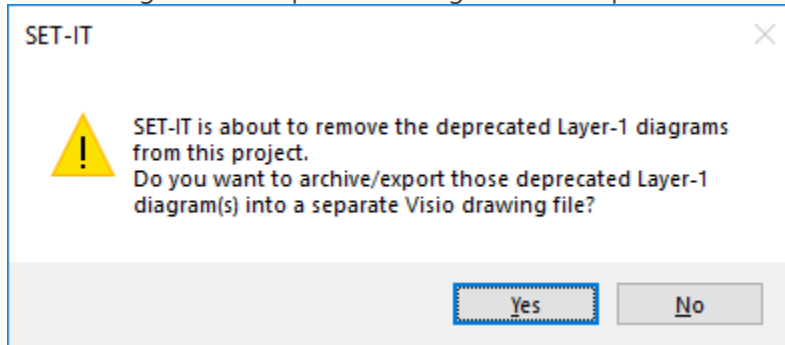

NOTE: You may get a pop-up asking about macros. The older SET-IT Visio drawing files were stored with macros and you can choose either option since you won't be using them.

Service Package Instances and Diagram names will be reviewed by the conversion process. Earlier versions of SET-IT allowed these to be called differently which sometimes caused confusion later. SET-IT will give the user the option to either:

- Update the Service Package Instance name to match the name used on the Diagram
- Update the Diagram name to match the name of the Service Package Instance
- Do Nothing – use what is shown for each of the names

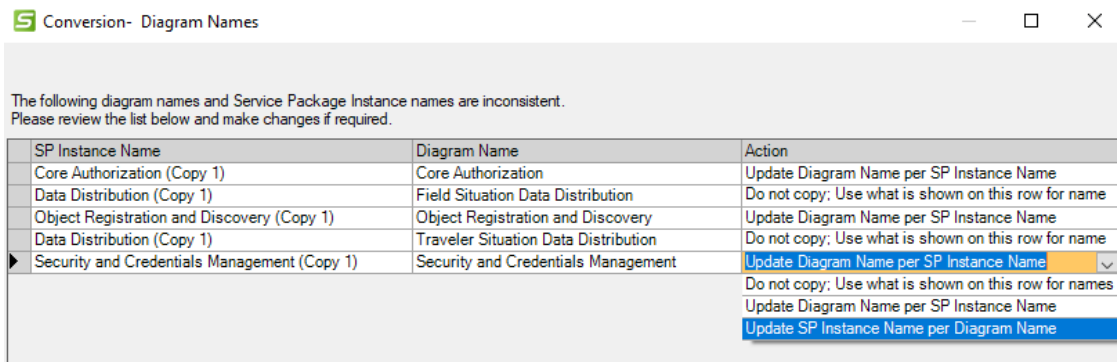

The default will be to use the Diagram Name

Diagram Verification checks are run during Conversion which may result in some of your diagrams being 'demoted' from Complete to Partial if any of the current rules are not satisfied. It will note that in the Conversion report at the end. Run the Diagram Verification test yourself after conversion to see what needs to be fixed on any of your diagrams.

Any aliases created or customized will be carried forward after conversion, even if a default alias in ARC-IT may be different than the alias you had defined.

SET-IT will also convert the Communications view content. Previous versions of SET-IT had communications template drawings which will no longer be in the right format so the conversion process will ask if you would like to save the old diagrams as Deprecated Communications Diagrams in Visio format.

NOTE: Converting from older files may lead to situations where there were 2 of something in the older architecture and now there are 5 of that same thing. The Conversion routines will not be able to sort out how to convert those cases. An example is the 2015 version of the Security Credentials Management System (SCMS) which had 2 functional objects. In the current version of ARC-IT that same physical object now has 5 functional objects. Conversion will not be able to know how to convert those functional objects so it will show the 2 as deprecated on the converted diagram. You will need to go through and manually edit your diagram to make sure the current functional objects are shown.

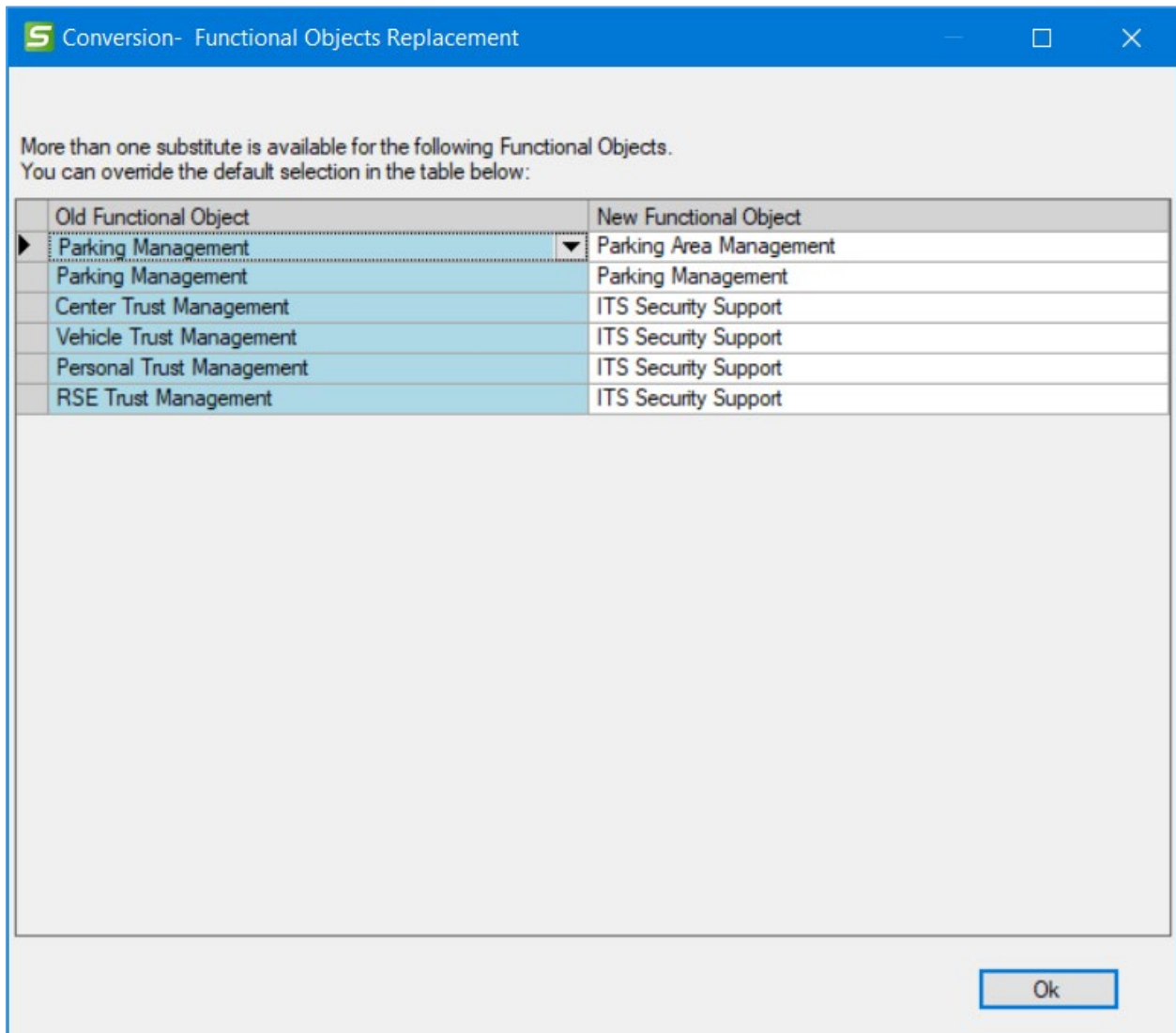

Information flows that were routed through an ITS Communications Equipment element they should be converted to use the "via" communications element in the current version; however, you may find that it needs to be manually reselected in Shape Properties after import.

Concept of Operations (ConOps) Templates are customizable. The Conversion process will look to see if you had customized the template using the previous version. To avoid any loss of your customized data, SET-IT will save an archived version of your old ConOps Template.

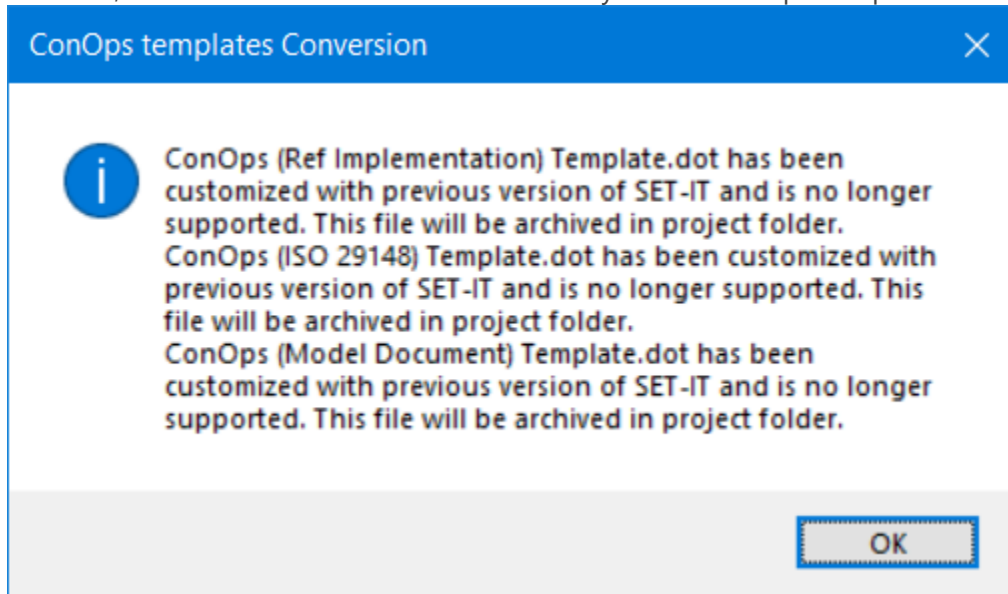

In other situations, the ConOps template itself may have changed as SET-IT has evolved. An example is the case in version 8.2.75 where the old IEEE 1362 based template was updated to match the current industry standard, ISO 29148.

In either case, you will want to check your ConOps at the end of the conversion process to see that it has your customizations. In the case where SET-IT archived your template to make room for the new template you will need to open both files and copy your customizations into the new template's structure. Use SET-IT / Output / Document / ConOps and click Edit Template for the new template and open your old template in a separate window using Word. Then move your customizations over and save the new template file. Now you should be able to regenerate your ConOps using the new format and new version of SET-IT but retaining your customizations.

You can watch the progress of Conversion displayed in the Convert Manager window. At the end of the process, you can click Save Report if you want to review the warnings and messages for the parts of the conversion process where changes had to be made to your data.

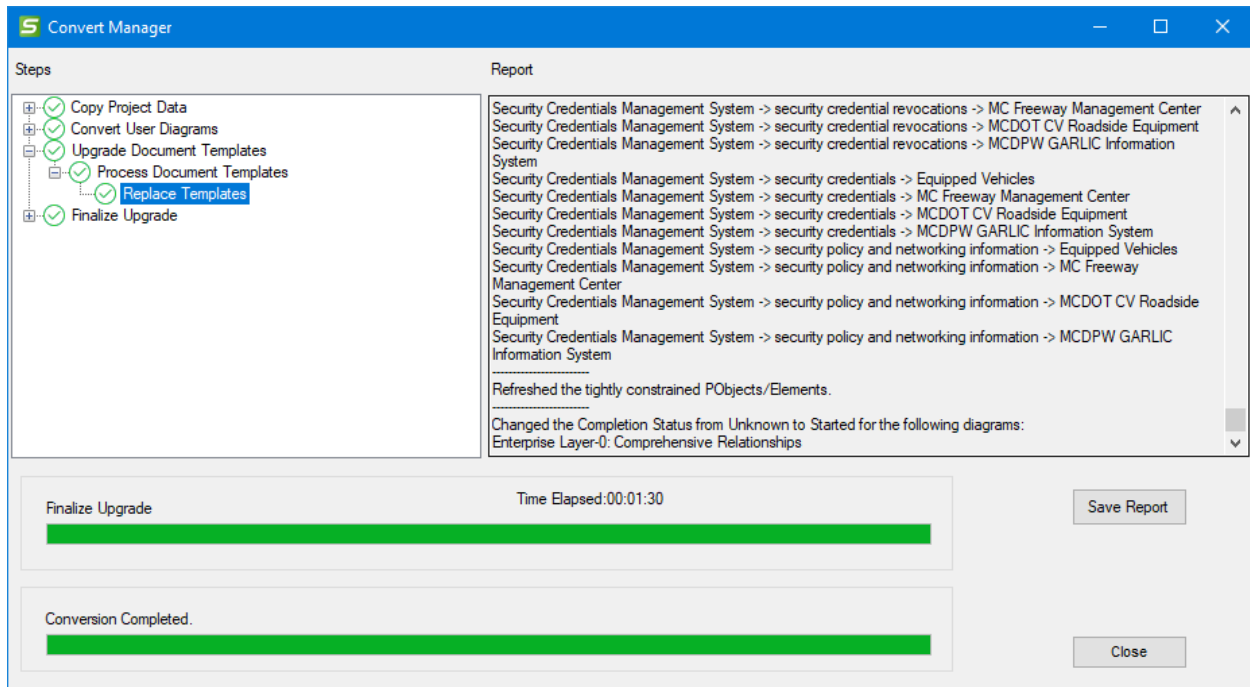

You may see #s added to some information flow names. That happens when SET-IT Conversion sees a flow name that is the same as an ARC-IT flow name but some characteristic – either a source, destination, or some other characteristic – is different than in ARC-IT.

You are given the option to save this report for later – that’s probably a good idea the first time you are converting to a newer version to make sure there are no surprises.

Next is an information screen directing you to see Help (this resource) for more information:

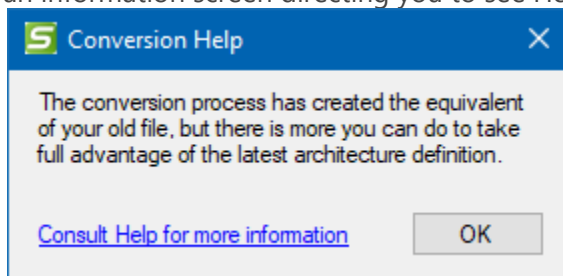

At this point, SET-IT will tell you that the Upgrade or Conversion is complete but that it needs to synchronize the data on the diagrams with the data in the database. Depending on the size of the project and, especially, how many diagrams there are this step could take a while.

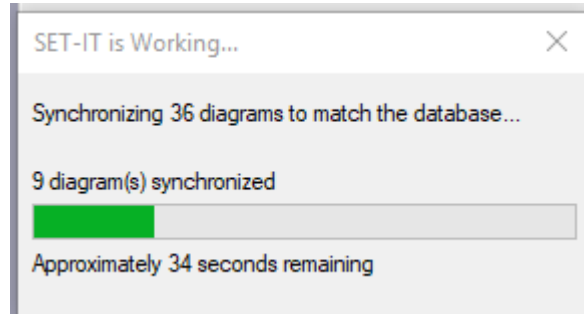
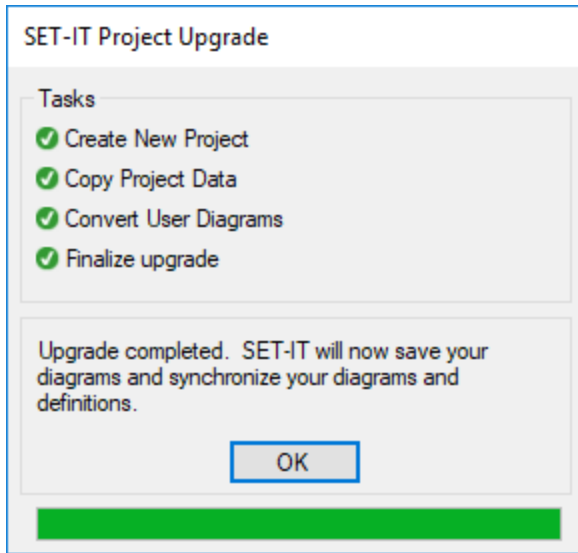

During conversion Sync will look at the various information flow combinations. Architectures developed in previous versions may have had flows developed around the Element Triples – the source and destination elements and the flow name. However, conversion may have increased the number of physical objects that element was assigned to. The sync process now needs to determine which combination of physical objects to use for that triple. You may see a screen like the Element Flow Triples Review form below for complicated triple combinations.

You are directed to look through the list and double-click the combinations you don't want to see in your converted/synchronized architecture. Once you double-click a row it will show up as red to indicate that it will be removed from the database when you click 'Apply'.

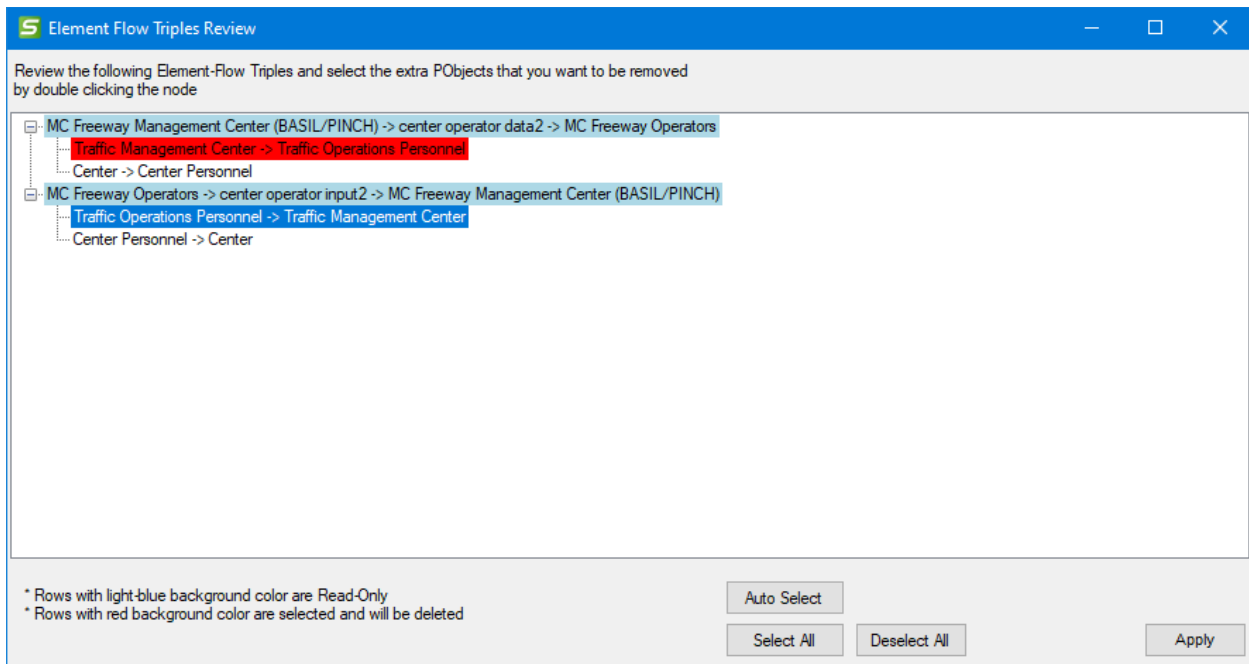

The Auto Select button will choose the combinations that are least likely – flows to or from the ITS Object or the generic 'Center' object, for instance. This will likely be a good thing to do, particularly for large complex architectures. Then you can review the red lines that were autoselected and use double-click the individual combinations further. There are also Select All and a Deselect All buttons if that helps.

When you done deciding which combinations to remove, click the Apply button. You will be asked if you are sure.

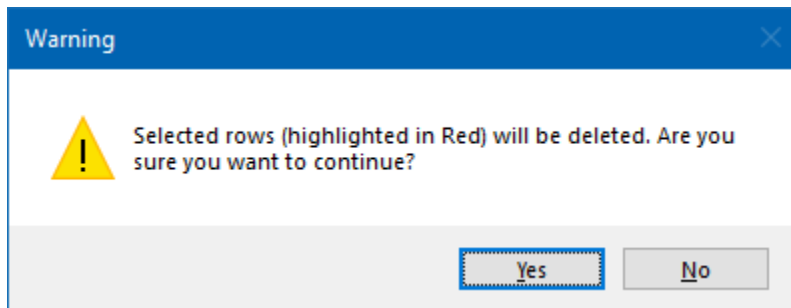

If there are no more triples with multiple physical object mappings, then the form will automatically close.

If there are still triples with multiple physical object mappings, then the form will remain open to show the remaining triples to be addressed. You can decide to address them now or you can simply 'X' out of the form and work on this later.

You will also be able to use this form as part of your review process from the Review menubar. Once complete you should *save* this project. You are now ready to use SET-IT with the latest ARC-IT definitions.

Save a Project

SET-IT is capable of saving changes made to a project. Projects include multiple files within a folder. Modified diagrams can be saved to the project folder. You can set a directory to be your default directory for SET-IT projects files folders.

There are two ways to **Save** a project.

Click the **Save** icon on the top ribbon,

OR

1. Select **Project** on the top menu,
2. Select **Save** from the pull-down menu,
3. Click **OK**.

You can also Save the file with a different name:

1. Select **Save as** from the pull-down menu,
2. On the **Save as** box identify the new project name and project location,

3. Click **OK**.

NOTE: SET-IT is designed to work in a Microsoft Windows environment and there are certain characters that you can't use in a filename and those are:

\ / : * ? " < > |

If you try to use one of those characters in a filename or folder name, you will most likely get an error message that says something about invalid path or filename. If that happens just try again without those special characters.

File Notes

SET-IT saves the information about a project in multiple files – a database, several Visio files, several Word documents, a text file for the log, and a small file with a .setit extension. The .setit file lets you double-click on it to start SET-IT and open that project. It also contains summary information about when the project was created.

Read-Only Files

When you open a project the database file is set to Read-Only to prevent you from accidentally opening another copy of the project and writing over data being edited on screen.

You may find yourself in a situation where you forgot your file was already open and try to open it again. You may see a message like this:

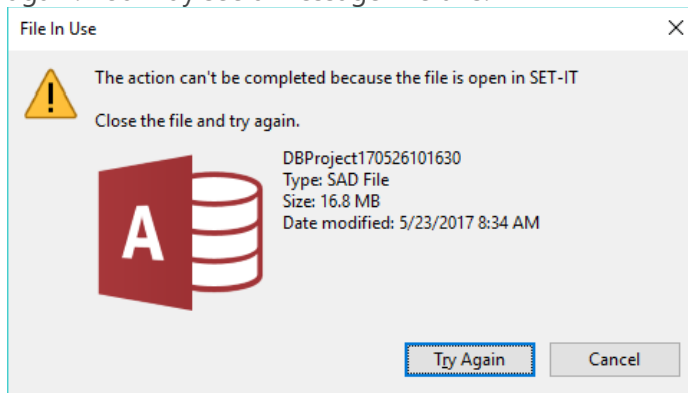

If so, just click Cancel and go to the window currently running and close that copy of SET-IT with that file in use and then click 'Try Again.'

Language Support:

SET-IT will work on computers that have different language settings. Note that this feature has not been exhaustively tested or verified.

AutoBackup

Another project management feature is called AutoBackup. You can enable this to periodically make a backup of your project's files. This has the effect of making a copy of your project's files that you

may need if there is a problem and you need to start over from a certain point. For example, if you mistakenly made the wrong changes to a project and had already done a Save. This will let you go back to your last backup and restart your work.

See the [Options](#) section for more information.

Save your work often.

Data is only saved when you choose the "Save" or "Save As..." options (or when you exit the file and save). All work you do between saves is put into a temporary file". As you work this temporary file grows in size. If you wait too long to exit and save, this file can grow so large you may not be able to save it.

In order to actually shrink the size of the temporary file while working with large architectures, you must **exit** periodically from the file, or from SET-IT. Saving the architecture places new work in the original user file in compressed format, but the temporary file remains at the same size and keeps growing. To shrink the temporary file, the database file must be closed.

SET-IT Crashed and I Forgot to Save!

If the tool should fail with unsaved data, you may be able to partially recover. Look for the temporary file in the Windows "temp" directory (e.g., C:\Users\\AppData\Local\Temp\ITS Architecture\SET-IT). Copy .sad file to your project folder and change the file name to be the same as your project name and then try opening the project with SET-IT.

A utility in the SET-IT Options Menu item provides a way to find and recover these temporary files. Click on File and Options. From there click Advanced.

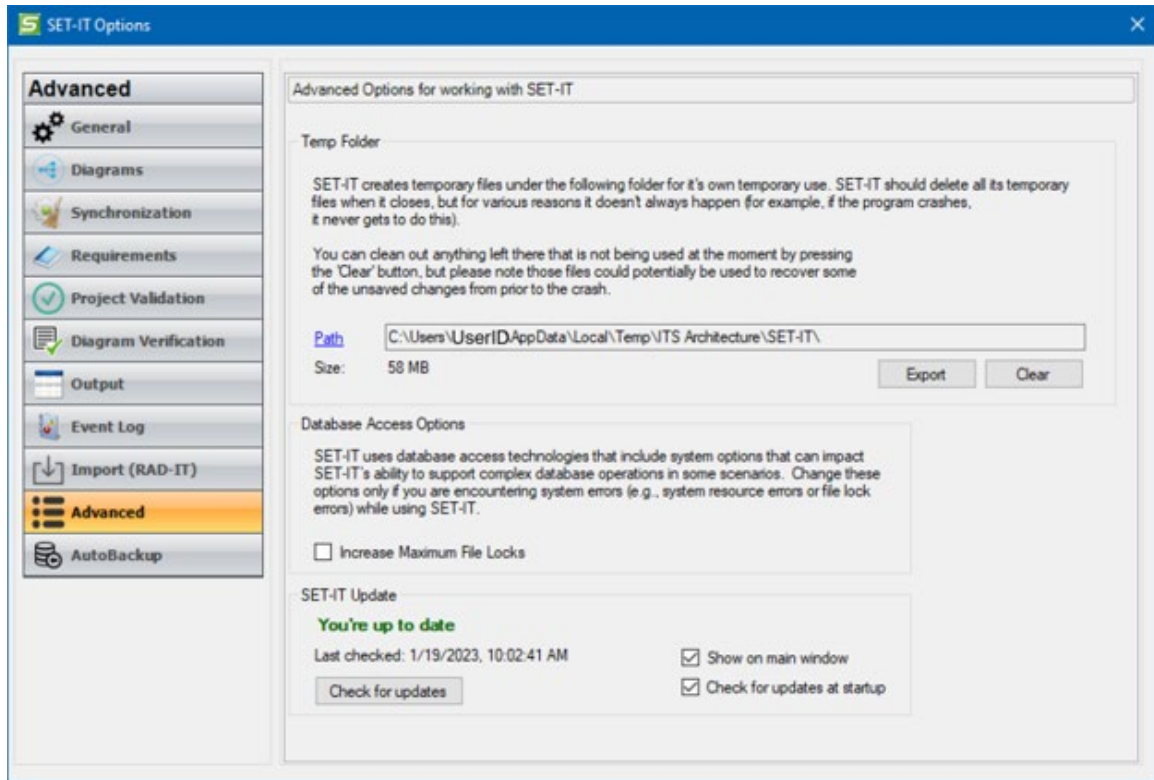

If you need to find a temporary file in order to restore it click “Path” and it will open the system file folder that contains the temporary files.

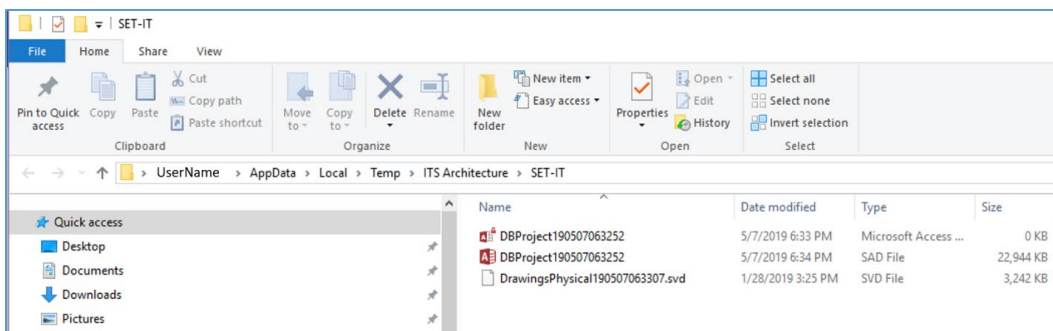

From this folder you can copy the temporary copy of the .sad file and re-open it in SET-IT. You may not be able to recover all of your data but in most cases most of your data will be preserved here.

Other Uses of the Temp Folder Window:

Clear – One quick way to reduce the size of the temporary files is to click the “Clear” button. That will instantly erase any but the file currently being used by SET-IT.

Export – Sometimes you may encounter a situation in which you need the help of the SET-IT support team to fix your file or to find out what is wrong with SET-IT. For some situations they may ask you to send them your temp files so they can help isolate the problem and debug any errors in the data or

software. In this situation, click Export to create a zip file of the temporary SET-IT files that you can email to the team.

Close a Project

1. Select **Project** on the top menu,
2. Select **Close** from the pull-down menu,
3. If there are pending changes you will be prompted if you want to save or not. Click **OK**. Or go back up and say you want to save your changes.

Print a Project

1. From an open Diagram select **Print** from the Project menu,
2. Select the Printer to use, and use the Print dialog box options or Properties button to change the settings before clicking OK.

Use the Outputs menu for many choices to create outputs of the diagrams and tables.

Export / Zip Up the Project Files

SET-IT saves the information about a project in multiple files – a database, several Visio files, several Word documents, a text file for the log, and a small file with a .setit extension.

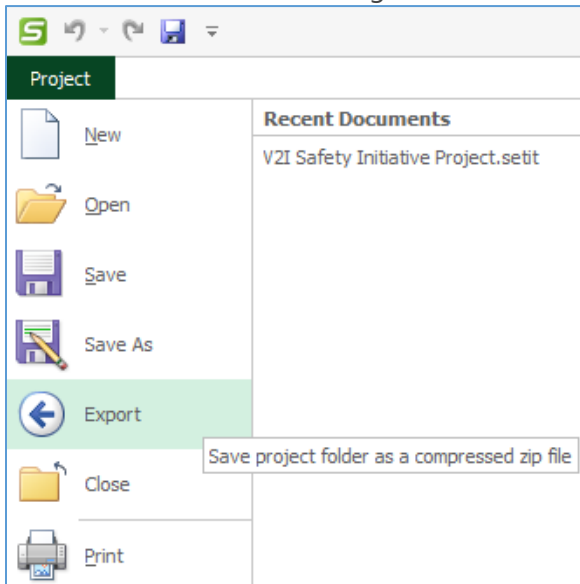

If you want to share your project with someone else, you have to share all the files in that directory.

SET-IT provides a utility to let you Export the project and all of its files in one compressed zip file.

Clicking Project then Export will open a File Save dialog window asking you to identify the folder and the filename to call this zip file. Enter a new unique name, something different than the name of the project folder so it will be able to create a new file.

SET-IT will take all the files in the project folder and create a compressed zip file that is compatible with most file compression programs, including Microsoft Windows, PKZip, 7Zip, etc.

You can email or share the zip file with another user. They can then expand the folder and open the .setit file to launch SET-IT and see the same things you had on your system.

This Export or Zip capability also provides a useful to archive versions of your project files to maintain a record of changes at various milestones during project development.

Access Help

Selecting **Help** from the Project menu gives you access to this file. You can also click on the question mark icon (?) located on the upper right corner of the screen.

Describe the Project

To display a high-level summary of your project, click 'Overview' in the navigation pane on the left side of the screen.

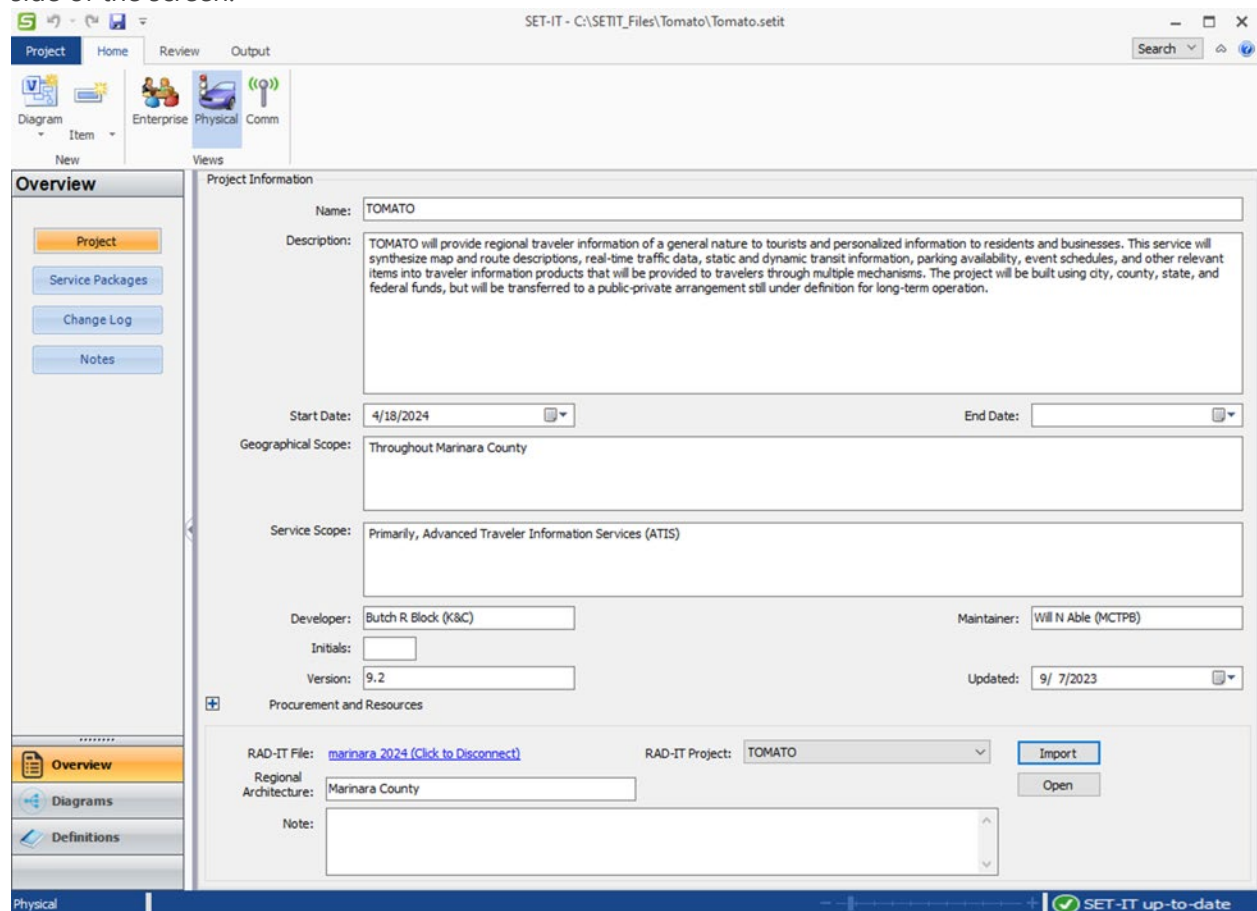

The first time a new project is created Name field will contain the name you entered on the dialog box when you started the project and everything else will be blank. The fields on the Project Information screen provides place to record a description of the project. The most direct output for this is the Project Information report, however details such as the Project Name (entered in the Name field) are also used to automatically populate the ConOps document with information.

Project Information

The Start and End date boxes let you establish the start date and end date for your project. Clicking the pull-down will bring up a calendar allowing you to select the year, month, and day for the start and end of your project.

The Geographical Scope and Service Scope fields are useful for letting project stakeholders know the extent of the project, e.g., the size of the region(s) involved in the project and the nature of the services/functions being developed, respectively.

The Developer and Maintainer fields can be used to show the individual or organization that created the project architecture and the individual or organization responsible for maintaining it. The Date field is used to set the date the current version of the architecture as represented in this Project was created or updated.

The initials can be up to 5 characters and are used on the title block of the drawings as they are updated.

The Version block is a text block. Some users want numbers but some use character strings to identify the version, e.g., 2.1a.

The date fields are pull-downs with a calendar feature to help you pick start and end dates for the project and the date when this SET-IT file was created and/or updated.

Additional Information on the Overview Screen

There is a "+" symbol just below the Version number that allows you to expand the screen to add additional project information: Procurement Strategy and Operations Resources. Both of which are to support items required in United States Code of Federal Regulations (CFR) 940 and the Federal Transit Administration (FTA) Policy on ITS Architecture and Standards. CFR940.11 on Project Implementation requires systems engineering analysis to include procurement options and Procedures and resources necessary for operations and management of the system. This allows the project to say how they intend to carry out this part of the project.

Click the "+" symbol on the screen and the screen will expand to show 3 additional fields.

Procurement and Resources

Procurement Strategy: Marinara County Department of Transportation (MCDOT) will pursue a design-build approach for the procurement of the consultant team to develop the new materials. A separate low-bid contract may be used, pending state approval, to procure installation services for the actual field devices.

Operations Resources: MCDOT will manage the new V2I Safety devices and the applications as part of the existing BASIL/PINCH traffic operations center. At this time, based on the early analysis, there is no need for additional resources though some additional training may be required for the staff.

Alternatives Considered: In addition to the Vehicle to Infrastructure services the original architects researched other options including a more traditional set of traveler information services. This V2I initiative will be able to provide more accurate sources of information and direct more relevant |

Procurement Strategy may indicate what types of contacting or options that were explored before deciding on the approach to be taken on this particular project. There may be more facets to procurement down the road since the right procurement option might be different for different parts of the project. For example, you may be procuring off-the-shelf field devices with a low-bid contract but using experience-based consultant services to create a modest extension to the center control software. One could cover how each part of the project will be procured on the overview form.

Operations Resources briefly describes changes in the staffing, training, tools, or hours of operation in order for the systems modified or created in this project to work. This should also reference the Procedures that will need to be in place or revised in order for the operators of the project’s systems to deliver the expected results. There may be multiple sets of procedures. For instance, different stakeholders with different roles and responsibilities, working for different agencies, would likely need different procedures and resources to meet their particular duties.

Alternatives Considered provides a field to describe any analysis of alternative system configurations and technology options that were explored as part of the development of the system architecture.

NOTE: One issue that has reoccurred on a sporadic basis is the wiping out of data entered on the Project screen from the Overview menu. This sometimes occurs with a new architecture and when the user has filled-in data for the cells on the Project Overview screen and then goes to another table or menu area. You may notice that your typing has been wiped out. To avoid disruption please do a SAVE before you leave the Project Overview screen.

The Region field allows you to identify the region that this project is taken from, also a requirement of United States Code of Federal Regulations (CFR) 940.11. If you import the project from RAD-IT, it will automatically populate this field if that information is in the RAD-IT file, or you can type it directly.

Importing a Project from RAD-IT

SET-IT can also import projects from RAD-IT – the Regional Architecture Development for Intelligent Transportation (RAD-IT) tool. In General Terms, RAD-IT:

- Guides users through the design of a Regional or Project Architecture, identifying and extracting the required portions of ARC-IT.
- Assists in local mapping and tailoring to a region’s needs.

- Helps the user with potential conflict resolution between Regional and Project Architectures.
- Provides a “jumpstart” toward architecture development and consistency with the National Architecture.
- Is a standalone application, also available at www.arc-it.net.

Regional and Project ITS Architectures

A regional ITS architecture defines the elements and information exchanges of the many ITS projects existing or planned within a region. It should be a comprehensive organization of the region's ITS. A region is a geographical area spanning one or more jurisdictions; its boundaries are defined locally and they may or may not conform to existing political boundaries. It could be a state or multiple states, a metropolitan area, or multiple metropolitan areas, one MPO or multiple MPO's, a corridor (e.g., I-95 corridor), counties, rural towns, or areas. Once a region has a regional architecture they can begin to identify projects to implement the vision of ITS in that region.

A RAD-IT file can include 1 regional architecture and many project architectures. A project architecture in RAD-IT can be a subset of the regional architecture and defines the elements and information exchanges of a single ITS project.

Steps to Import a RAD-IT Project

Importing a project from RAD-IT will import that information into your currently open project in SET-IT. If you already have information populated, including descriptive text, service packages, customized elements, etc. then the Import will add to and in some cases replace what you currently have. If that is not what you want to do, then close the current project and start a new SET-IT project to use for importing from RAD-IT.

Use the link on the bottom of the Project Overview screen to identify the location of the RAD-IT file that contains the regional architecture.

If the file is open in RAD-IT you will get a pop-up message saying, "The selected file appears to already be open in another application. Please close the other application so SET-IT has exclusive access to the file." If this happens, you can simply go close (and probably Save) your RAD-IT application and then try again to select that file here in SET-IT.

Once you have found and selected the RAD-IT file use the pull-down to select the project architecture from that file that you wish to import. That will then automatically populate the RAD-IT Region field with the name of the Regional Architecture in that .radit file. Alternatively, you can manually enter the name of the regional architecture if you are not yet ready to import the project architecture from that file. As soon as the project is selected it will overwrite the Regional Architecture field with whatever is in the .radit file.

You can also add a Note to describe that project and how it may be applied in SET-IT.

RAD-IT File: [marinara \(Click to Disconnect\)](#) RAD-IT Project: ▼

RAD-IT Region: MCDOT Saucelito Traffic Coordination
MCDOT Traffic Monitoring Expansion Project
MCDOT V2I Safety Initiative
TOMATO

Note:

NOTE: This tool will only let you import Project architectures defined in RAD-IT of a similar version. You will not be able to import an entire regional architecture or from an older architecture file. Go to RAD-IT and create a project and make sure it's converted to the most current level.

NOTE: Save and close the RAD-IT file before starting to import it into SET-IT.

After identifying the RAD-IT file and the project in that file, click the Import button and the process will start.

1. **Status** – first step is to align the status values if they were different. For instance, if something was called Planned in RAD-IT it will become Project by default but you can use the pull-down to change it. Then click Continue.

Status Import	
Imported Status	Will Become
▶ Planned	Project
	Existing
	Project
	Future
	Not Applicable

The status values in the two files don't match. Change the mappings above if desired.
Click Continue to proceed to the next Import steps.

NOTE: Not Applicable cannot be used to translate an imported status.

2. **Project Overview** – the next step is to show how the Project Overview attributes will be imported from the RAD-IT file. You can select one or more fields to import. Click Continue.

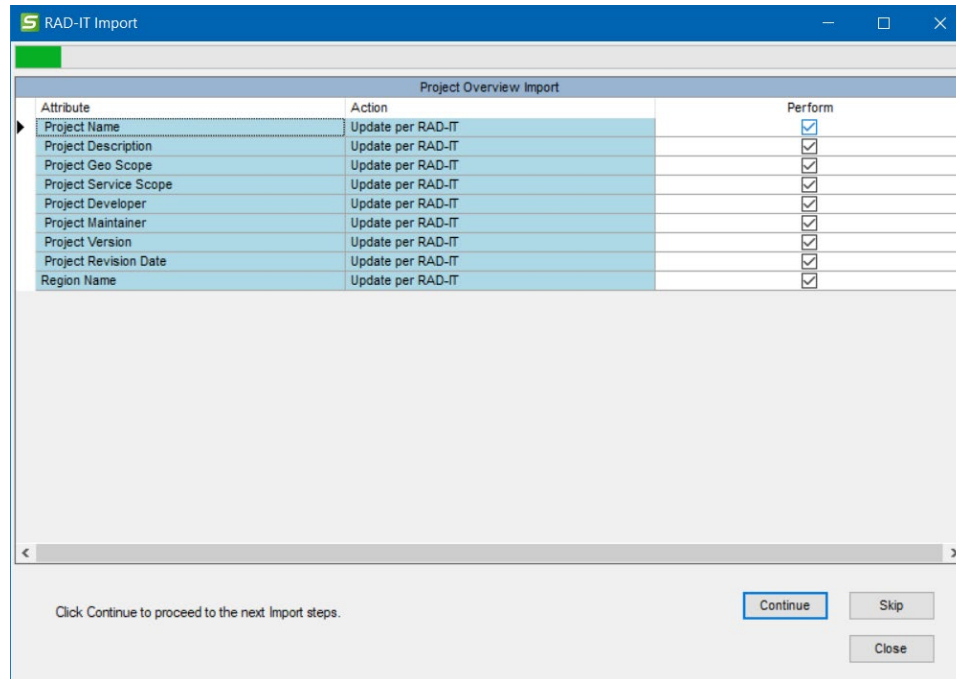

3. **Applicable Regions** – any regions that are different than what is already in SET-IT will be shown in order to be imported. Click Continue.
4. **Stakeholders** – next, the system will display a list of the stakeholders that are going to be imported from the RAD-IT file. This list may include stakeholders indirectly associated with an element of the architecture (e.g., members of a group that “own” a TMC, etc.), in addition to stakeholders explicitly included on the RAD-IT Stakeholders Tab. Click Continue.
5. **Physical Objects** – next, the user defined unique physical objects that are part of the RAD-IT file will be shown. Click Continue or Skip. Clicking “Skip” will mean that any user defined physical objects that were in the RAD-IT file will not be imported but the rest of the import process will continue.
6. **Functional Objects** – next, the user defined unique functional objects that are part of the RAD-IT file will be shown. Click Continue or Skip. Clicking “Skip” will mean that any user defined functional objects that were in the RAD-IT file will not be imported but the rest of the import process will continue.
7. **Elements** – as shown below, the next step is to show the list of Elements to be imported. In some cases, it says “Add” and in some cases it says Add (Element is connected to project’s interfaces). Import takes an expansive view of what to import to make sure the SET-IT project has enough to work with. Click Continue.

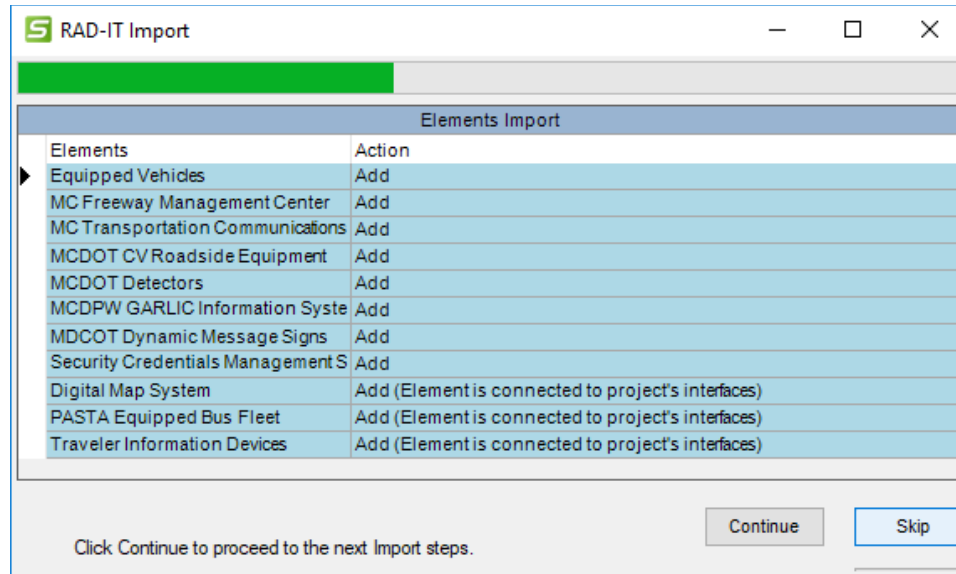

8. **Service Packages** Now SET-IT lists the service packages to be included. A new Service Package diagram will be created for each Service Packages to be included in the new SET-IT project file. Click Continue.
- This step will take longer because SET-IT is importing diagrams for each service package to match what was in the RAD-IT file and then synchronizing the diagram to the database information imported from RAD-IT.
 - You may get a screen regarding shapes that weren't included on a RAD-IT service package diagrams. Regional Architectures may not include an element for every possible physical object that is shown on an ARC-IT service package diagram. As a project for that region is then imported into SET-IT you can decide what to do. Either,
 - i. Click Yes to remove those shapes that are not applicable to the project, or
 - ii. Click No and let SET-IT build the diagram normally (which may show you additional opportunities for systems and devices you may want to include in your project).

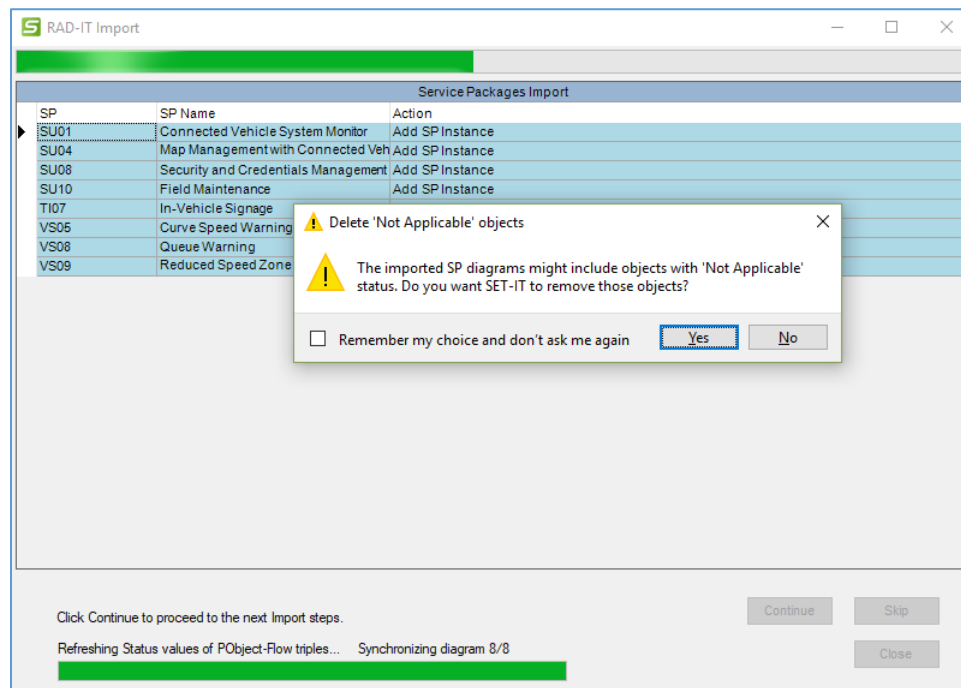

NOTE: This part of the process may take a while depending on how many service packages are to be imported.

NOTE: Some have seen a Clipboard error while the service package diagrams are being imported. If you get a Clipboard In Use error in the middle of that process then it will give you the option to skip that diagram. It may be best to exit SET-IT, close any other programs running, and start SET-IT again to make sure the right diagrams and database definitions are imported together. One other workaround is to go into the Windows Settings for the Clipboard and make sure the Clipboard History setting is 'Off'. This prevents the clipboard from keeping other things that may interfere with SET-IT during diagram/document generation or import.

NOTE: The Diagram Clean-Up tool can help put back shapes that were deleted or that are no longer necessary.

9. Flows Import – the next step will be a list of user-defined or project-unique information flows from the RAD-IT file that are to be imported. Click Continue or Skip. Select "Skip" if you will not need to use those user defined flows in your project. If an Alias was defined and/or applied in RAD-IT then that will also be imported and noted on this screen.
10. Interfaces Import – this step will list any interfaces that need to be imported that are not already on one of the service package diagrams. You may see a pop-up window (dialog box) informing you that some of the flows are not on any diagrams. Use this information that will be saved in the Import Report that you can open or save in Word or Excel at this end of this process to edit your diagrams so you can put them onto the appropriate diagram.

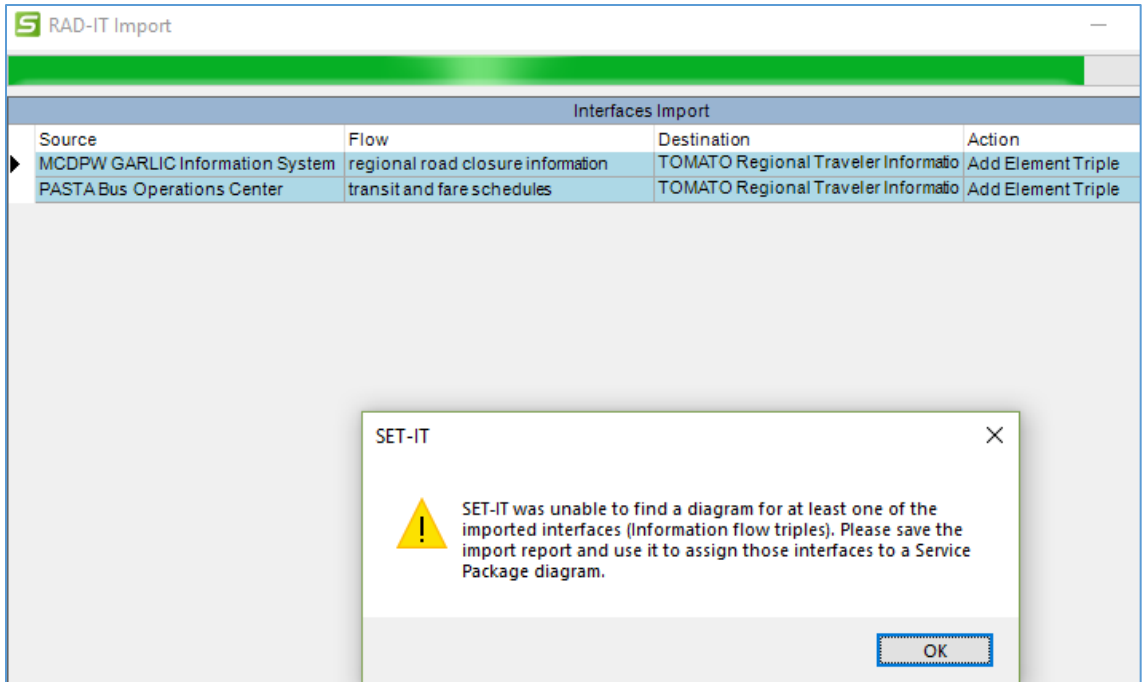

11. Communications – this step is actually several steps that will list the communications issues, standards development organizations (SDOs), standards, profiles, and solutions to be imported that were created/defined in the RAD-IT file.
12. Needs – this step will list the Need Areas then Needs to be imported that are not already included in the Service Packages imported in step 7 above. If a Need Area was in the RAD-IT project but did not have a corresponding Service Package in RAD-IT, then it will not be imported. You will see this in the Import Results report at the end.
13. Requirements – this step will first show any Requirements Sources and then list the functional requirements defined in the project to be imported. It will show “update allocation” for requirements already defined in ARC-IT as well as new requirements that are not already defined in the ARC-IT based set of requirements for the service package and their functional objects previously imported, i.e., user defined requirements. While SET-IT now has the option to define System-level requirements, the files from RAD-IT will still only contain element or functional object-based requirements. If the RAD-IT file in question had previously contained an imported SET-IT project, then any system level requirements will be imported back into SET-IT if the service packages are still valid.
14. Agreements – this step will list any stakeholder (enterprise view) agreements defined in the RAD-IT project to be imported.
15. Import Completed – now press Close and see the RAD-IT Import Report. This report can be exported in either Word, Excel, or Text (CSV) format.

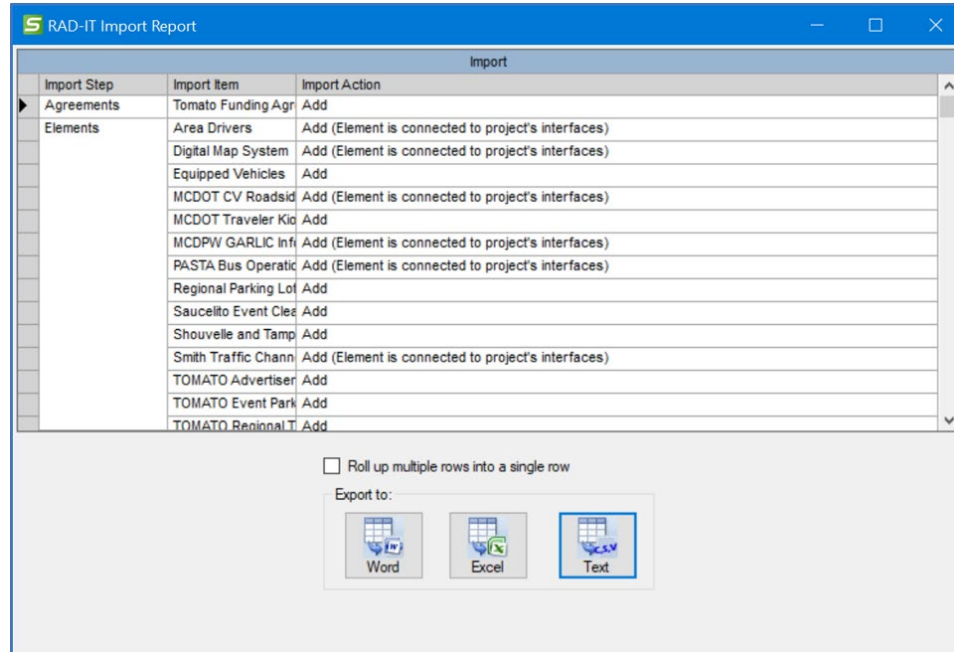

16. After exporting the report, click the X to close this RAD-IT Import Report window and it will then complete the necessary refresh of the database and definitions.
17. Now your project Overview screen shows the information from the imported RAD-IT project.

Notes on Project Import from RAD-IT

- Some RAD-IT projects may have multiple elements of the same physical object participating in a service package. TM08 Traffic Incident Management is a good example where there may be more than one traffic management center in a project. SET-IT imports service package diagrams from the ARC-IT reference model and, in the case of Traffic Incident Management or TM07 Regional Traffic Management shows one box for a TMC and one box for Other TMC. If a RAD-IT project is defined to show multiple TMCs (say a state DOT's center, a county, and a city center) then you will need to edit the diagram after the import process is done. It will map both of your traffic management centers to both shapes. Use Shape Properties so that one center is mapped to one shape and the other center is mapped to the other shape.

After Import (before editing):

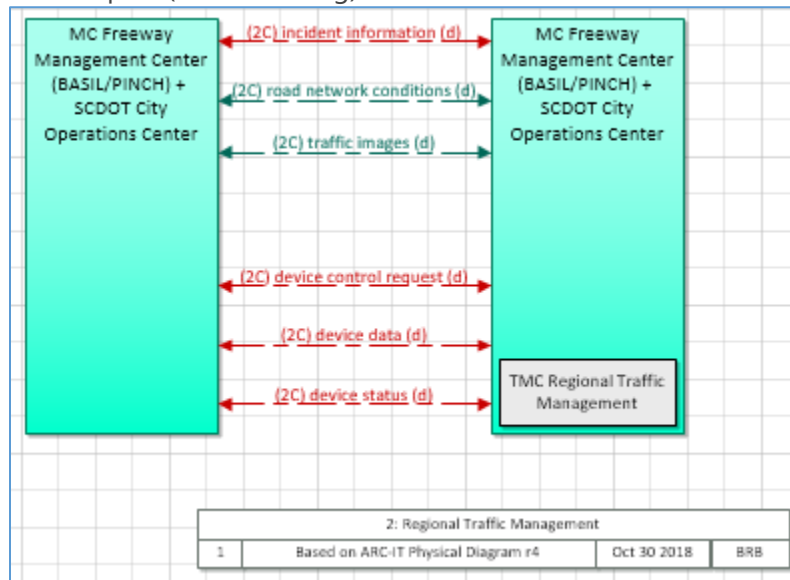

After Editing with Shape Properties:

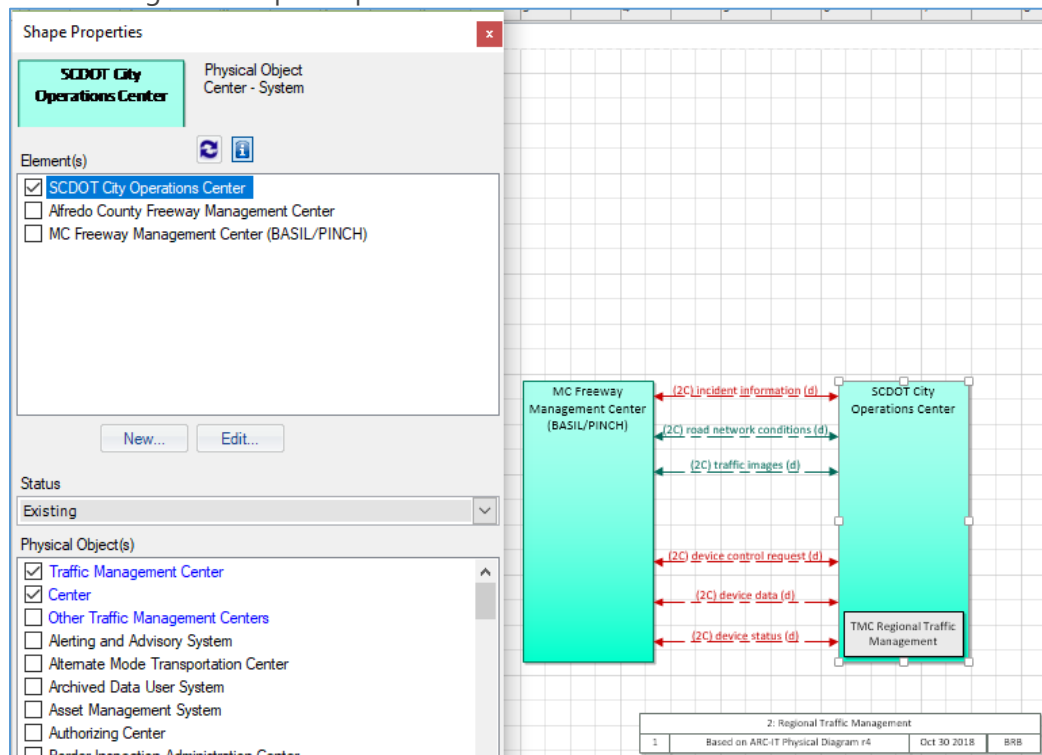

- Beware of going back and forth between RAD-IT and SET-IT too much – as in importing a project from RAD-IT into SET-IT, editing it in SET-IT, then importing that back into RAD-IT; there may be some issues where not everything is always mapped the same way between tools. The import tools will take care of most data schema differences but too many 'round-trips' may have issues that will need to be addressed manually.

- Aggressive Builds in RAD-IT may mean that there are more interfaces in the project than appear on a Service Package diagram. In RAD-IT Build Settings are used to determine the flows to include on the Interfaces Tab and which flows are to be included as part of the scope of the project architecture. The user can then customize the grid in RAD-IT to include or exclude flows between elements based on their needs. During import into SET-IT the service packages listed in the RAD-IT file are included along with the associated elements and interfaces. There may be a situation where a flow was added in RAD-IT that didn't appear on a Service Package. The user will be notified about this situation during import and warned that they may not want to use the import report that's available at the end of the process to find and fix those cases.

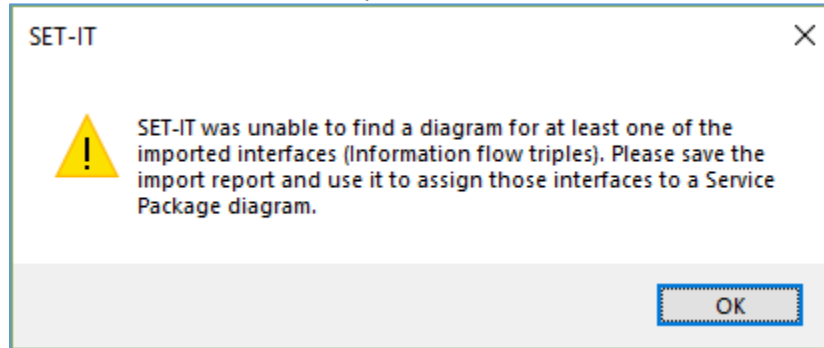

TIP: if you get this message, be sure and Open/Save the report you are offered at the end of the Import process. It will tell you what Information Flow Triples it could not assign to a diagram.

A	B	C
Import Step	Import Item	Import Action
Interfaces	MCDPW GARLIC Information System-->regional road closure information-->TOMATO Regional Traveler Information Center	Failed to find a diagram for the triple.
Interfaces	PASTA Bus Operations Center-->transit and fare schedules-->TOMATO Regional Traveler Information Center	Failed to find a diagram for the triple.

Then you can edit you diagrams to include them on one or more of your service packages.

- RAD-IT projects can include custom choices about standards to include in a project. Once you have imported the project go to the Communications View and select the "Flow Triples to Profiles/Standards" grid to see the project-unique standards and their mapping to information flows in the project.
- With version 9.1 SET-IT projects can include service package implementation diagrams which represent a subset of an entire service package. Currently RAD-IT does not include support for service package implementation, so they won't affect import into SET-IT.

Questions about Import

- Can I Import Another Project? Yes, you can change the project and import another set of project data from that same RAD-IT file. This might help build a 'super-project' to include services identified in multiple projects in the RAD-IT file.

- BEWARE: if the 2nd project had different mappings/relationships then you will be warned. Importing multiple projects into the same RAD-IT file should be done with care as the links to the previous project will not be preserved.
- What if I Make Changes to that RAD-IT file? You can reimport that RAD-IT project into SET-IT and SET-IT will update those same components in RAD-IT to reflect the changes. It will basically go through all the steps outlined above to import a project and will tell you the places where it will "Update per RAD-IT file".
 - But to be able to take advantage of this, you must keep the name of the RAD-IT file the same. If you were using the filenames to help keep track of your configuration it may be better to keep the filename the same and zip it up and put a date or version indicator on the zip file name.

Select Service Packages

ARC-IT has over 150 service packages. Each service package represents a slice of the architecture that combines physical objects, functional objects, and information flows to deliver one or more intelligent transportation and/or connected vehicle services and satisfy a set of needs and requirements in the surface transportation environment. Some of these are Safety based, some are Mobility oriented, others are geared to protecting the Environment, and others are there to Support the other services. Most were defined by US DOT projects in the United States but others have been defined internationally and are now part of the reference architecture. This provides project designers with a broad range of ideas and definitions for consideration when developing their own projects.

Model Systems Engineering (SE) Documents Service Packages.

You can use the Requirements Options to change the source of your project to use one of the Model Systems Engineering (SE) documents published by FHWA. See the "Requirements Options" section. If you do that then the Service Package listing will indicate "(Model Document)" next to the name of the Service Package. You can use the search capability and search on the phrase, model document, to see which ones those are.

The table below shows which services are connected to the model documents.

SP Identifier	Service Package (SP) Name	SP Implementation	Model SE Document
TM01.1	Infrastructure Based Traffic Surveillance	Detector Based Surveillance	Traffic Sensing and Detection Systems (TSDS)
TM01.2	Infrastructure Based Traffic Surveillance	Video Monitoring	Closed Circuit Television (CCTV) Systems
TM03	Traffic Signal Control	All 3 implementations are covered	Central Traffic Signal Systems
TM06.1	Traffic Information Dissemination	Dynamic Message Signs	Dynamic Message Sign (DMS) Systems

When you select one of the services for which the model documents were based then it will import the needs and requirements associated with the model document in place of the ARC-IT needs and requirements written for that service package.

NOTE: More than one copy of a model document cannot be added to the same project. You will get a warning message to that effect if you try to include a 2nd copy of one of the service packages listed above.

Service Package Selection Window

The Service Packages screen available as part of the Overview menu is shown below:

On the Service Packages window, the full list of Service Packages is shown on the left. The following columns are used to classify the service packages:

- Type (Convenience, Environmental, Informational, Management, Mobility, Regulatory, Safety, or Support),

- *Group* within each Type, whether or not it is already in your project (0=no and 1 or more tells you how many copies or *instances* of that service package are in your project)
- *Service Area* for that Service Package, e.g., Traffic Management, Support, Data Management, etc.

When a row is selected (click on the left side of the row) the top right box will show the description of the Service Package from ARC-IT and the bottom right will show the Layer 2 Physical diagram from the architecture. The Description will also say how many diagrams are included.

You can sort the list(s) by Type, Group (of service packages), or Name by clicking the heading at the top of each column. Click it to sort that column alphabetically either ascending or descending. Use the Combine Type or Combine Group check boxes at the top of the window to combine the columns and hone your sorting for what you are interested in.

Click the “Group” button at the bottom to re-sort everything by Type, Group, and Service Package Names with the service packages / applications that have already been included in your project at the top of the screen.

TIP: Be careful using too many filters when viewing the Service Package screen, you may end up with a blank screen if you filter everything out. Click one of the checkboxes at the top to reset the filters and sorts.

Is it possible to have more than one “instance” of a service package in a project? Yes, it is possible to have multiple instances of a given service package, depending on the specific characteristics of a given project. You may, for instance, decide to show one version of a data distribution service to show the streaming of mobile sourced data through a data clearinghouse before going on to centers subscribed to that type of data. And then perhaps another version of data distribution to show the distribution of information from a management center out to the traveling public.

Service Package Implementations

On the Service Package Selection window there is a check box to “Show Implementations”. See the Service Package Implementation Glossary entry for more information.

Click the “Show Implementations” button to expand the list to include Service Package Implementations. These are subsets of the main service package that are used to show alternatives to implementing that service. For instance, the Emergency Vehicle Preemption service (PS03) has 5 implementation options:

SP Identifier	Service Package Implementation Name	Notes
PS03.1	Traditional Field Control	Based on direct communication between the Emergency Vehicle and ITS Roadway Equipment
PS03.2	Traditional Traffic Management Center (TMC) Control	Managed in real-time by the TMC based on direct communication between the Emergency Vehicle and ITS Roadway Equipment.

SP Identifier	Service Package Implementation Name	Notes
PS03.3	Center to Center Coordination and Control	Granted based on negotiation between the Emergency Management Center and Traffic Management Center
PS03.4	Cooperative ITS Field Control	Based on direct secured and authenticated communication between the Emergency Vehicle and ITS Roadway Equipment via Connected Vehicle Roadside Equipment (RSE)
PS03.5	Cooperative ITS Center-to-Center Coordination and Control	TMC-controlled and Connected Vehicle Roadside Equipment is used to coordinate preemption status with emergency vehicles at the intersection. Optionally, the Emergency Management Center can coordinate signal preemption in this center-based approach.

When you click to highlight one of the Service Package Implementations you will see a different diagram with fewer objects and lines than shown on the parent service package. You will also see a difference in how some shapes appear. On Service Package Implementation diagrams the objects and flows are characterized by their *Inclusion* status using the following values and methods:

- *Fundamental* to that service package implementation, i.e., it won't work without it. These use a bold outline, bold text, and wider width for flow lines.
- *At Least One of*; the service package needs to have at least one of these types of shapes in order to work properly. These use a normal outline, normal text, and a normal/solid line.
- *Optional*; the service can still work without this. These use italicized text with dotted lines.

NOTE: currently the Inclusion values are set to read-only and are the values imported from the ARC-IT reference database. The lines are encoded in such a way that the type faces of each flow name in implementation diagrams are based individually on the inclusion value assigned to the relevant flow triples. As with status, SET-IT shows each flow triple's inclusion value in Shape properties when that flow is highlighted. For encoding how the flow line appears, SET-IT rolls up to the highest inclusion value of all flows on the line.

Including Service Packages

Once you have selected the service packages / applications to include in your project's architecture click the "Include" button at the bottom of the window; SET-IT will then copy the physical diagram(s) from the ARC-IT reference diagram file into your project file. SET-IT also copies the Needs and Requirements from SET-IT that were developed in ARC-IT for the selected service packages.

Depending on your Options you may also be able to import Needs and Requirements from one of the FHWA Model Systems Engineering Documents. See the "Requirements Options" section for more information.

SET-IT has now created an "instance" of that service package for your project.

When you include more than one instance of a service package, SET-IT will import a second copy of the needs and requirements so you can have unique needs/requirements for each service package instance.

NOTE: Some Service Packages have more than one physical view drawing. SET-IT will include both drawings and you can decide to customize both as part of your project or delete one that you are not going to use.

NOTE: Because SET-IT synchronizes the name of the Service Package Instance with the name of the diagram, if a service package includes multiple diagrams it will create multiple Service Package instances.

NOTE: Items in the Service Packages menu that cannot be edited are shown in blue; in this menu you are limited to making changes in the white column which indicates which service packages you wish to include. Select or deselect service packages by checking or unchecking the appropriate box in the "Include" column.

Missing Service Packages

You may notice as you browse the list of service packages that there seem to be some gaps in the list. Not every Service Package in the reference architecture (ARC-IT) website is listed in the Overview / Service Packages window. This is due to a couple of reasons. The first is regional. Some service packages are specific to the region in which they were developed. Most of the 150+ service packages are available for all the current regions – United States (US), Canada (CA), European Union (EU), and Australia (AU).

The following service packages were defined in Australia:

- CVO16 Electronic Work Diaries
 - o With v9.1 there is an Implementation of CVO16 for US projects.
- CVO17 Intelligent Access Program
- CVO18 Intelligent Access Program – Weight Monitoring
- CVO19 Intelligent Speed Compliance

They do not show up in US projects unless you change your Settings in the Options menu to include Australia as one of the applicable regions.

Consult the Services Packages page on the [ARC-IT Website](#) for more information about those service packages. If you are working on a project in the United States and want to try one of those international services, you can go to Project / Options and add Australia as one of your regions. The list of Service Packages will now include the Australia defined services.

Where's SU07? The other type of service package that will not show up on the menu for a project architecture is the Support type of service that is focused on defining just the underlying communications between ITS objects. This is listed as SU07 ITS Communications on the ARC-IT website. Its diagram is shown below:

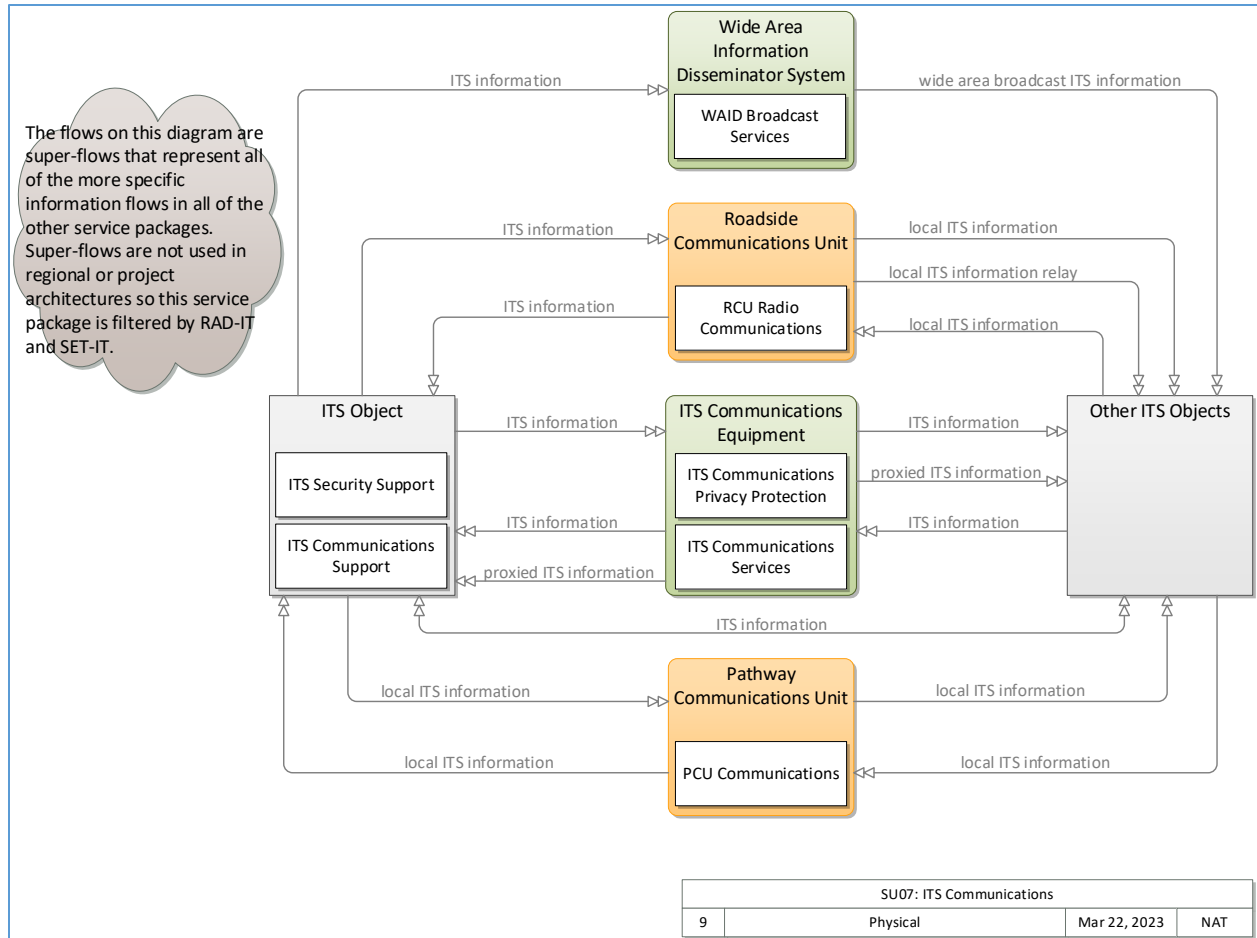

As the comment on the diagram indicates, SU07 consists of what are called “super-flows” that represent all of the more specific information flows that go between the ITS objects in a project. This service package is only defined in ARC-IT in order to model the underlying communications rules. Project or Regional Architectures do not need this service package.

Previous versions may have included this service and if those are converted they will have a note in the Conversion Summary report. You should probably remove SU07 from your project after conversion to avoid conflicts between the regular information flows and the “super-flows”.

Searching for Service Packages

If you are interested in a particular type of ITS or connected vehicle technology but aren't sure if it's included in the Architecture, you can search for it using the box at the bottom of the Service Packages window. Where it says, “Enter search text here...” you type in the phrase you are interested in and click “Search”.

Overview

Project

Service Packages

Change Log

Overview

Diagrams

Definitions

Show Implementations Combine Type(s) Combine Group(s)

Service Packages						
Include	SP	In Project	Instances	Implementation		
<input type="checkbox"/>	TM06	1	0	TM06	Traffic Information	
<input type="checkbox"/>			1	TM06.1	Dynamic Message S	
<input type="checkbox"/>	CVO09	0	0	CVO09	Freight-Specific Dyn	
<input type="checkbox"/>	DM01	0	0	DM01	ITS Data Warehouse	
<input type="checkbox"/>	MC03	0	0	MC03	Roadway Automate	
<input type="checkbox"/>	MC05	0	0	MC05	Roadway Maintenanc	
<input type="checkbox"/>	MC06	0	0	MC06	Work Zone Manage	
<input type="checkbox"/>	PS01	0	0	PS01	Emergency Call-Tak	
<input type="checkbox"/>	PS06	0	0	PS06	Incident Scene Pre-	
<input type="checkbox"/>	PS10	0	0	PS10	Wide-Area Alert	
<input type="checkbox"/>	PT03	0	0	PT03	Dynamic Transit Op	
<input type="checkbox"/>	PT10	0	0	PT10.1	Wide-Area Wireless	
<input type="checkbox"/>			0	PT10.2	Short Range Commu	
<input type="checkbox"/>	ST07	0	0	ST07	Eco-Lanes Managem	
<input type="checkbox"/>	TI03	0	0	TI03	Dynamic Route Guid	
<input type="checkbox"/>	TI06	0	0	TI06	Dynamic Ridesharin	
<input type="checkbox"/>			0	TI06.2	Dynamic Ridesharin	
<input type="checkbox"/>	TI07	0	0	TI07	In-Vehicle Signage	
<input type="checkbox"/>	TM03	0	0	TM03	Traffic Signal Contr	
<input type="checkbox"/>			0	TM03.1	Pre-Timed (Fixed Ti	
<input type="checkbox"/>	TM12	0	0	TM12	Dynamic Roadway V	
<input type="checkbox"/>	TM16	0	0	TM16	Reversible Lane Ma	
<input type="checkbox"/>	TM18	0	0	TM18	Drawbridge Manage	
<input type="checkbox"/>	TM20	0	0	TM20	Variable Speed Limit	
<input type="checkbox"/>	TM22	0	0	TM22	Dynamic Lane Mana	
<input type="checkbox"/>	TM24	0	0	TM24	Tunnel Managemen	
<input type="checkbox"/>	VS06	0	0	VS06	Stop Sign Gap Assis	
<input type="checkbox"/>	VS16	0	0	VS16	Automated Vehicle	

Include Group Search

This service package provides driver information i message signs or highway advisory radio. A wide including traffic and road conditions, closure and information, and emergency alerts and driver adv drivers at specific equipped locations on the road equipment provides the information at points in t and can tailor their routes to account for the new equipment and interfaces that provide traffic info the media (for instance via a direct tie-in between television station computer systems), Transit Mar Transportation Information Centers. A link to the Center allows real time information on road/bridge and construction activities to be disseminated.

This service package includes 1 physical diagram i

(You don't have to click Search – since SET-IT will start searching as you type.) The Service Packages window changes to only show Service Packages from the Architecture that include the phrase you entered – in their title or in their description. It will also show service packages that include your search text in the physical objects, information flows, or functional objects included in the service package diagram. There is a toggle button to turn Case Sensitive searching on and off depending on how precisely you need to search.

Open a Sample Project

SET-IT provides users with an example project which may serve as a starting point for new users; it includes a basic set of objects and interfaces that are common in many ITS or connected vehicle projects.

Opening and Saving the Sample Project

Click on Project Tab to open navigation pane; click on 'Sample Project' folder.

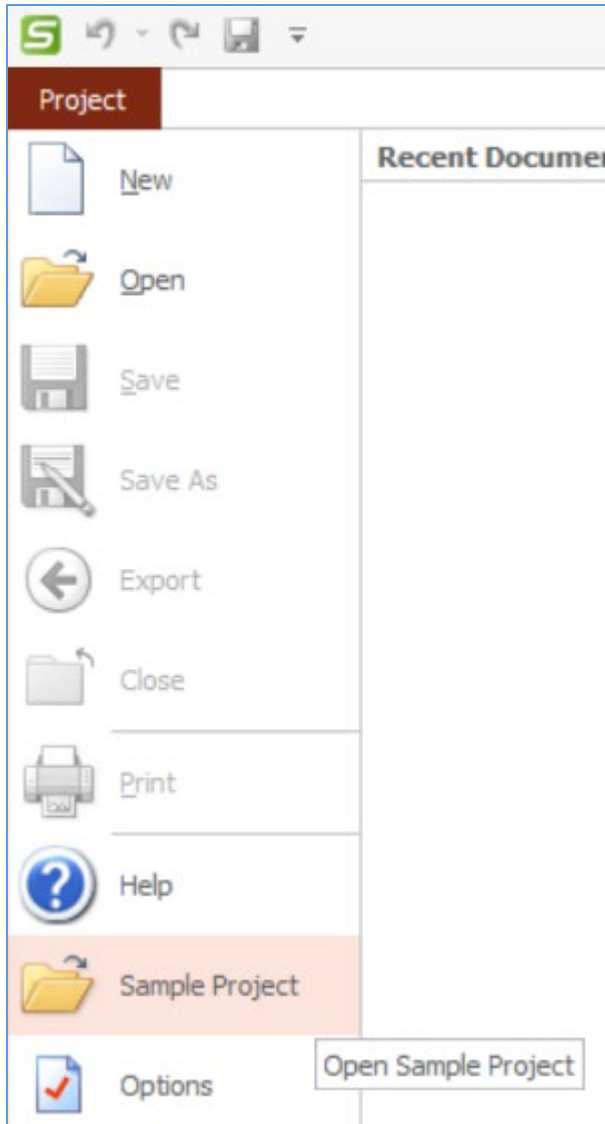

The Create New Sample Project dialog box will open, showing “V2I Safety Initiative” in the Project Name field. You can change the name if desired, otherwise confirm that the location shown in the Project Location field is where you want to store the sample project (files) and click OK.

Clicking on the Sample Project option brings up a window called **Create New Sample Project**. This window is like the Save As window and allows you to save this sample as your own project into your own file folder. Use this window to choose the file folder and the name for the project.

Now you can edit the file, add to it, change the names to match your own, or just review or print out portions of the sample project to better understand how SET-IT works and how to build a connected vehicle project architecture.

More on the Sample Project

The sample project's file name is the "V2I Safety Initiative" and once it is open the longer name for the project appears as the "MCDOT V2I Safety Initiative". It portrays a project developed as part of the fictitious Marinara County's regional ITS architecture. In SET-IT the idea is to show a project that demonstrates how to include system elements, Vehicle-to-Infrastructure Safety service packages along with support services and systems that will be needed for a connected vehicle project.

The sample architecture currently includes twelve Layer 2 Physical diagrams, two Layer 1 physical diagram, a Layer 0 Physical diagram, and a Layer 0 Enterprise diagram. The project includes the following services, shown on the layer 2 diagrams:

- Connected Vehicle System Monitor
- Curve Speed Warning
- Data Distribution
- Device Certification and Enrollment
- Field Equipment Maintenance
- In-Vehicle Signage
- Location and Time
- Map Management
- Queue Warning
- Reduced Speed Zone Warning / Lane Closure – 2 diagrams – one for a Wide Area Wireless implementation and one for a Cooperative ITS based implementation.
- Security and Credentials Management

Use this sample as a starting point for your own project architecture or simply to refer to how these concepts are shown.

One thing you may notice is how the diagrams are organized. In order to create multiple Enterprise Diagrams you will see multiple physical layer 0 diagrams to match. You may want to try this method in your project – create multiple physical layer 0s then create multiple enterprise layer 0s to show different aspects of your project.

The current version of SET-IT now includes all of the service packages, objects, and flows that comprise ARC-IT. This includes merged content from both the former National ITS Architecture and CVRIA so they can be included in your own project just like other ITS or connected vehicle applications defined in the Architecture.

SET-IT Options

There are a number of options that a user can establish and change in order to personalize the software.

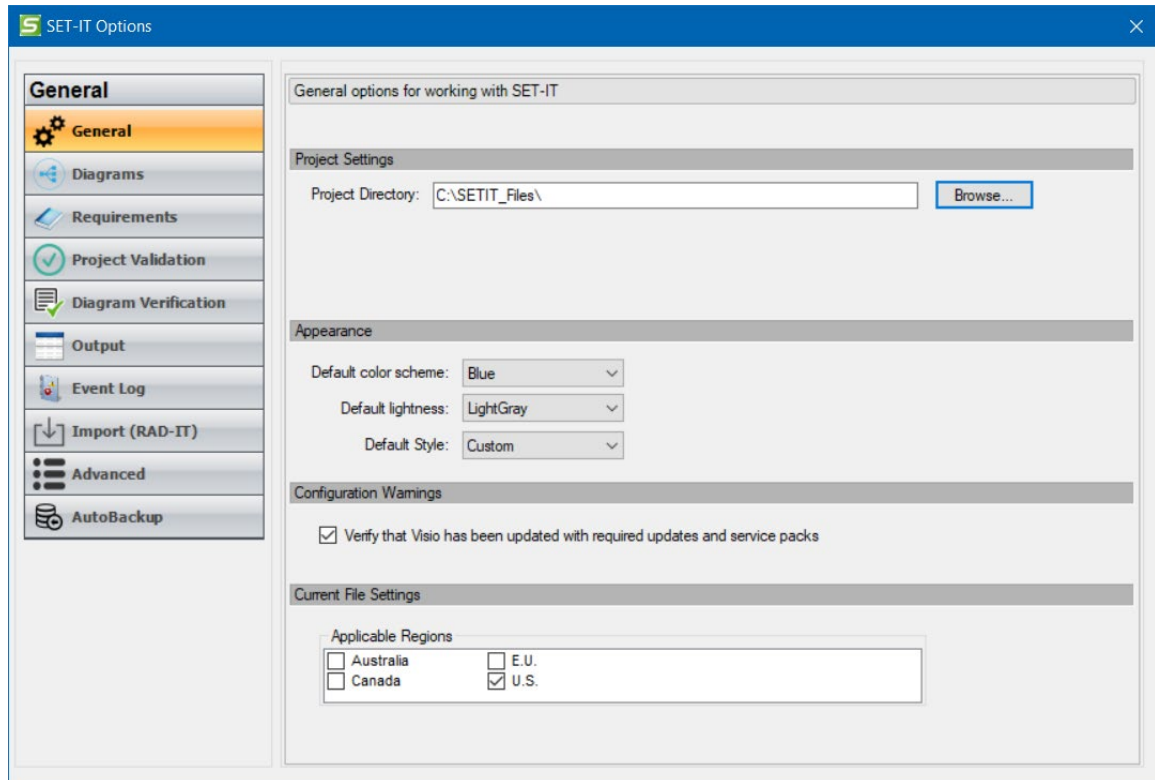

Note: The Applicable Regions area will be blank until a new project is started.

1. Select **Project** on the top menu,
2. Select **Options** from the pull-down menu and a pop-up window will appear with 9 tabs on the left: General, Diagrams, Requirements, Project Validation, Diagram Verification, Output, Event Log, Import (from RAD-IT), Advanced, and AutoBackup. See details about each type below.
3. When you are done making changes to the SET-IT Options just close this window by clicking the **X** at the top right of the window.

General Options

The General Options page provides settings and options to control the general behavior of the tool and some that are specific to a project when it is opened.

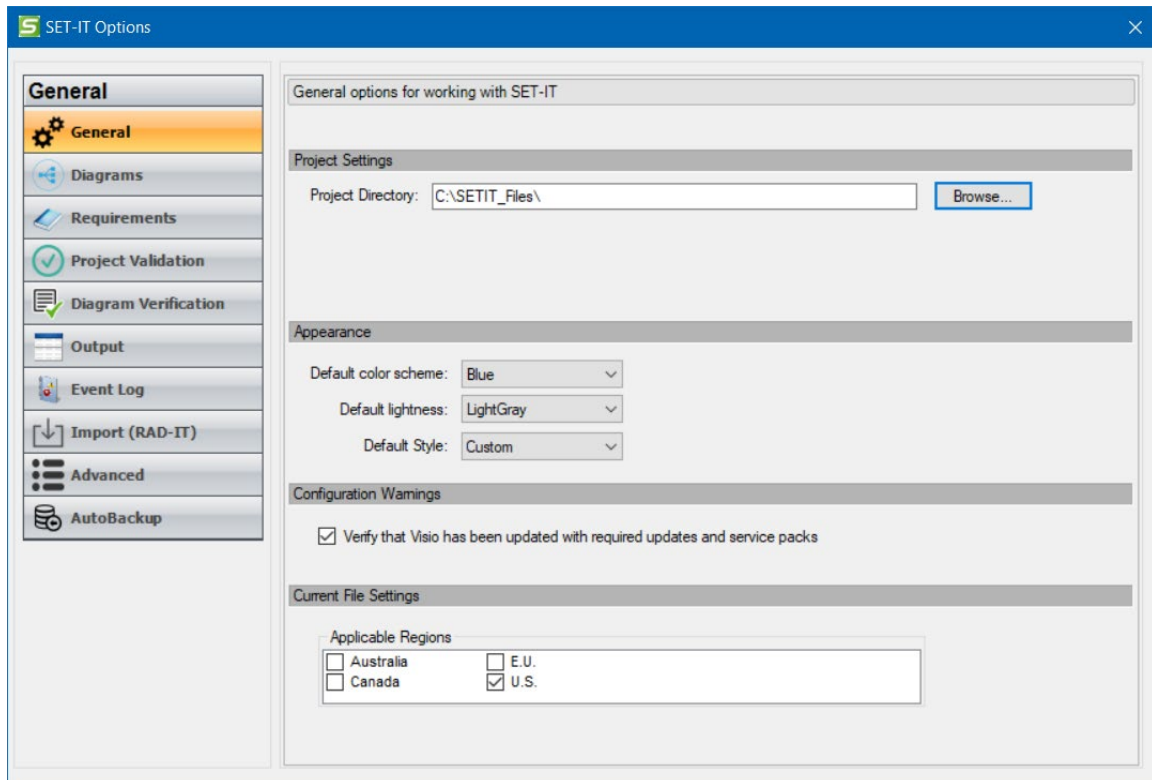

- **Project Settings:** used to set a default directory for your SET-IT project files. Use the Browse button to navigate your file system and select the directory or folder that will be used as the default starting point when you Create, Open, or "Save As" a project.
- **Appearance:** used to set defaults for the color scheme, lightness, and styles for the project files
- **Configuration Warnings:** used to verify that you have current versions of Office, and specifically, Microsoft Visio, in order to support proper SET-IT functionality.
- **Current File Settings:** used to set the Applicable Regions for the information to be included in your project. Choose from Australia, Canada, the European Union (E.U.) or the United States (U.S.) to determine what objects, flows, services, communications solutions, etc., are made available to choose from as you build your project.

For example,

- Select US and EU as input sources on the Settings screen.
- On the Overview->Service Packages table SET-IT displays services that come from EU or US only. So, an Australian-unique service, for example would not make the list (you may notice a gap or 2 in the list of service packages).
- Select the service packages to include.
- SET-IT imports the services and then removes the content (physical objects, functional objects, flows) that are not relevant to the US or EU.

These settings are also used as you create user defined flows, physical objects, and functional objects. As you create those components they will be stored in the database as having those applicable regions. Later, if you change the settings to display components from another region those components will not be shown.

Diagrams Options

The Diagrams Options page provides settings and options to how and when certain messages should be displayed. It includes options that control the behavior of the diagram creation processes and appearance.

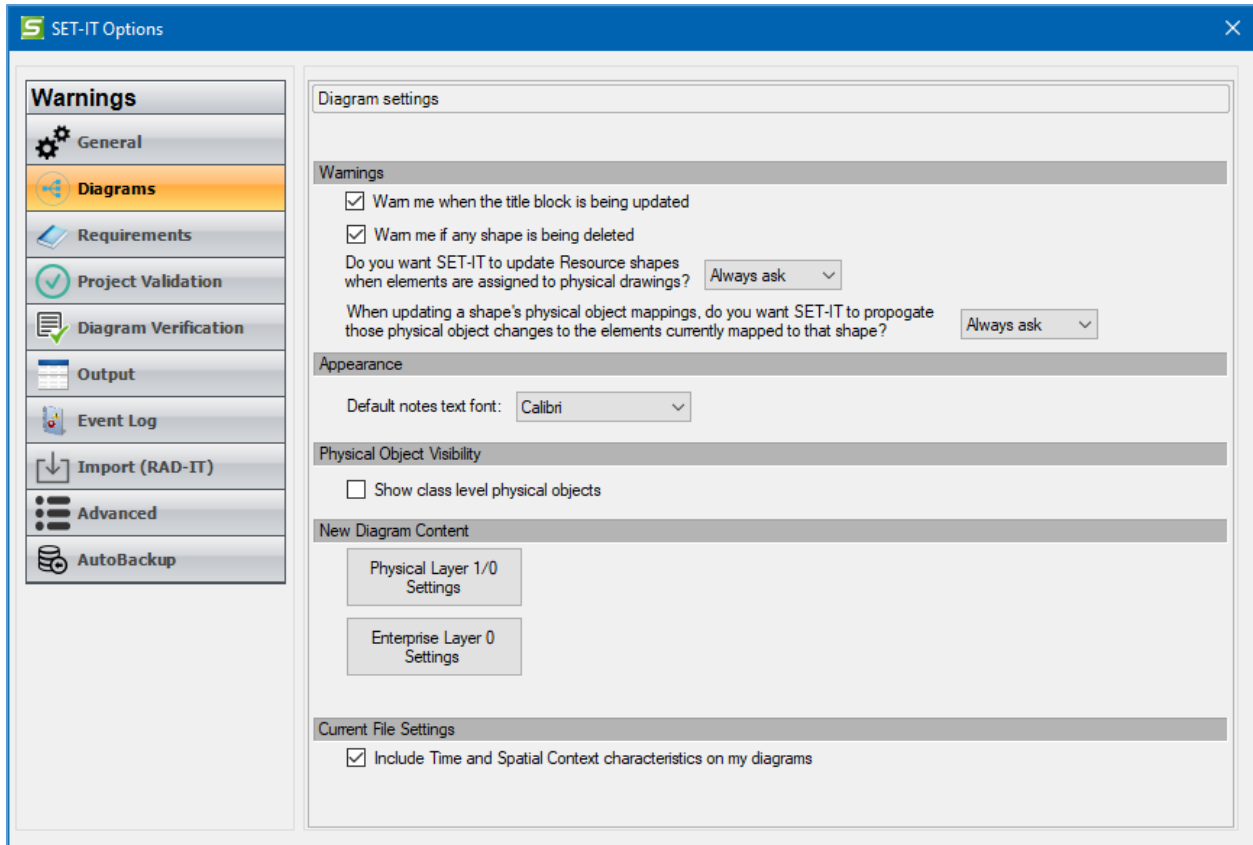

There are 5 areas to the Diagrams Settings options screen:

1. **Warnings:** includes checkboxes to set or change when warnings will be issued:
 - a. "When the title block is being updated"
 - b. "If any shape is being deleted"

Resources Question: asks if you want SET-IT to update Resource shapes [in Enterprise view] when elements are assigned to physical drawings. Choices from the pull-down are Always Ask, Yes, or No.

Physical Object Mappings: it also asks, "When updating a shape's physical objects, do you want SET-IT to propagate those physical object changes to the elements currently mapped to that shape?" Choices from the pull-down are Always Ask, Yes, or No.

2. **Appearance:** used to set the Font to be used as the default in the notes boxes
3. **Physical Object Visibility:** this has an option to "Show class level physical objects". For many users they will not need to know or see the automatic mappings that SET-IT makes to the Center, Field, Personal, and Vehicle physical objects. These physical objects are called class-level or level 1 objects that contain common functions and interfaces for any element created in that class. As a user maps an element to one of the level 2 or specialty level physical objects in those classes, SET-IT will automatically map the class level object to that element. This option gives the user the ability to see or hide those class-level object mappings.

4. **New Diagram Content:** includes 2 buttons to control what is included on the Enterprise or the Physical Layer 0 or Layer 1 drawings:
 - a. Physical Layer 1/0 Settings: See the next section for details on the [Physical Layer Diagram Settings Window](#).
 - b. Enterprise Layer 0 Settings: see below for details on the [Enterprise Layer 0 Diagram Settings Window](#).
5. **Current File Settings:** The bottom option on this screen has a checkbox to Include (or exclude) Time and Spatial Context flow characteristics on the diagrams, either layer 0, 1, or 2. See the Flow Characteristics discussion in the [Identify Shape Properties for a Flow](#) section. They will take affect on your diagrams as soon as you close the Options window.

Physical Layer Diagram Settings Window

When you click the “Physical Layer 1/0 Settings” box another window opens to change how the elements are positioned and lines are drawn on the higher-level diagrams.

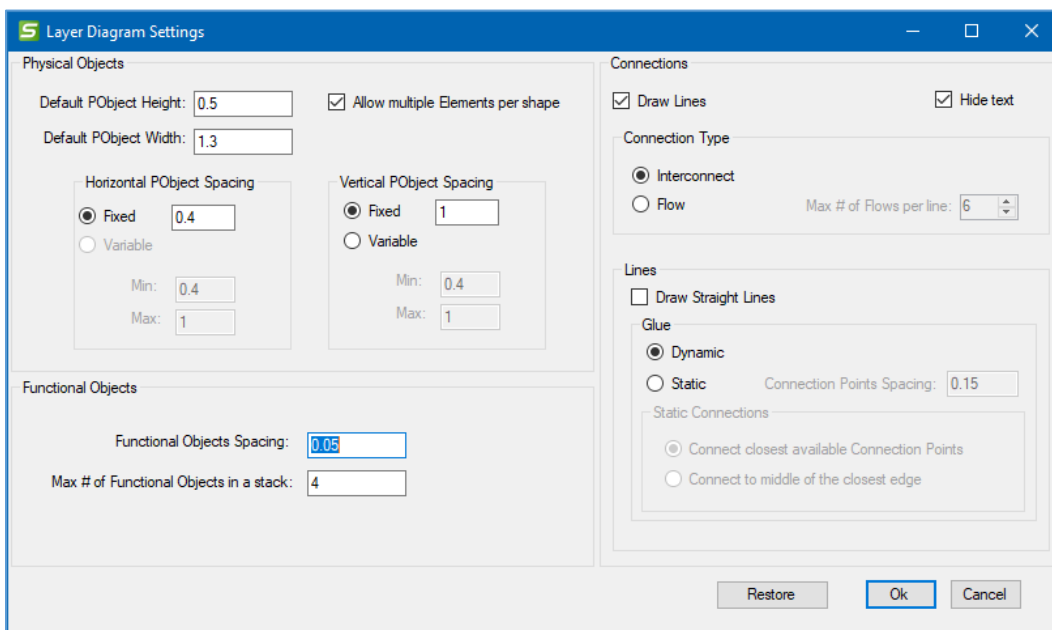

The Layer Diagram Settings window allows you to manipulate details such as how tall or wide to allow a shape to get or how far apart shapes should be and whether to draw lines with dynamic or static connections to the shapes.

You can also choose to show Interconnects or Flows on your Layer 0 or Layer 1 diagrams.

It is recommended to only make changes to these settings once you have become comfortable with the layer 1 or layer 0 diagram generation process and are needing to tweak certain things.

NOTE: sometimes you may notice differences in the way the text on some buttons looks or inconsistencies in the labels for different columns. This may be caused by a Display Setting that some Windows users select called Font Scaling. SET-IT attempts to scale the appearance

of text as well as other Windows programs but when users select 125% scale or greater then they may occasionally see some differences, e.g., some button labels may be truncated or letters will run together. If this happens try adjusting the Display Settings to 100%.

The “Restore” button at the bottom of the settings window allows you to reset all of the changes that have been made to the settings to their original defaults.

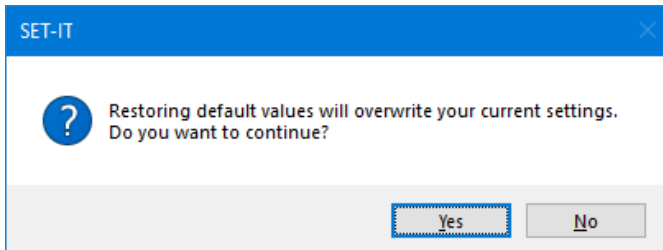

Enterprise Diagram Settings Window

When you click the “Enterprise Layer 0 Settings” box another window opens to change how the shapes are positioned and what lines are included on the enterprise view diagrams.

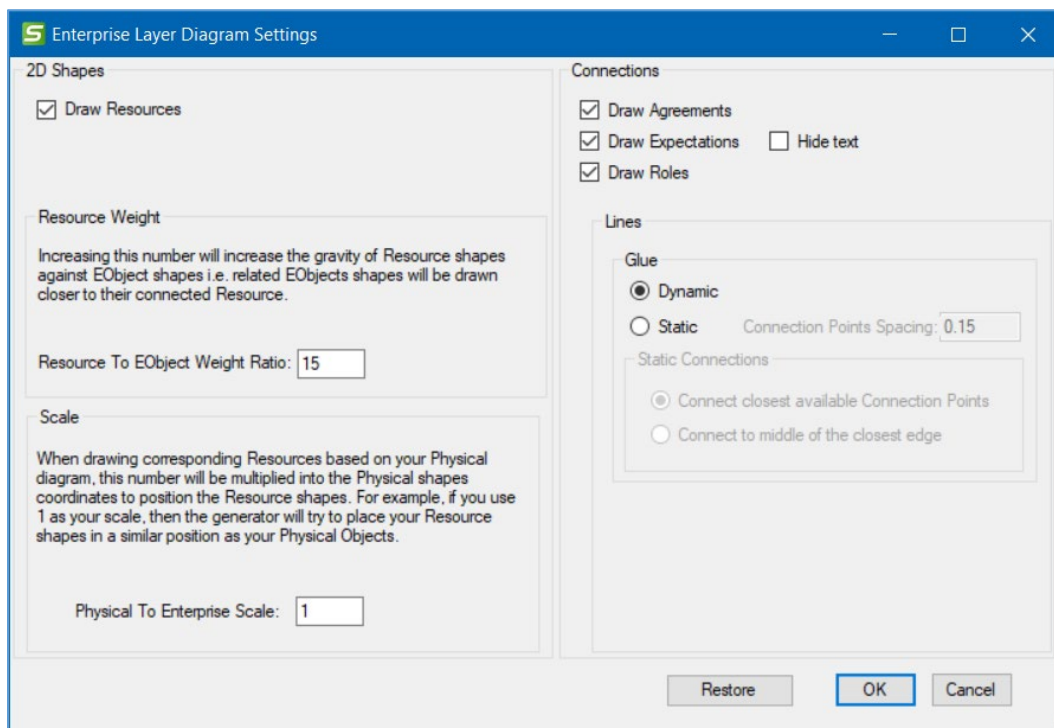

The first checkbox on the left let’s the user decide whether to include Resources on the diagram. Resources are typically associated with the elements shown on physical view.

To the right, there is a set of checkboxes under the heading of “Connections”. These let the user decide whether to include Agreements, Expectations, Roles, or some combination of those on the enterprise diagram.

If “Draw Resources” is unchecked on the left side of the settings window then the “Draw Roles” box will be greyed out since it would not be applicable since Roles are between an Enterprise/Stakeholder and the physical object or element.

There is also a “Hide text” box that the user can check if they just want a clean diagram without the lengthy names of agreements and expectations.

The “Resource Weight” and “Resource Scale” section provide settings to control how close and how similar the resources should be placed on a diagram relative to the placement of their corresponding physical elements on the physical layer 0 diagram. Use the Weight to position the a stakeholders resources closer to the stakeholder box or further away if you are trying to spread things out with a complicated set of agreements.

The “Restore” button at the bottom of the settings window allows you to reset all of the changes that have been made to the settings to their original defaults.

Requirements Options

The Requirements Options allow a user to establish whether they want to continue to use ARC-IT as the source for their requirements or to choose an alternative source. An alternative source could be one of the Model Systems Engineering Documents that have been written by Federal Highway Administration (FHWA) for relatively simple projects like deploying a Dynamic Message Signs (DMS), Closed Circuit Television (CCTV) cameras, Signal Systems, or other traffic surveillance and detection systems (TSDS). See [Model Systems Engineering \(SE\) Documents Service Packages](#) for more information.

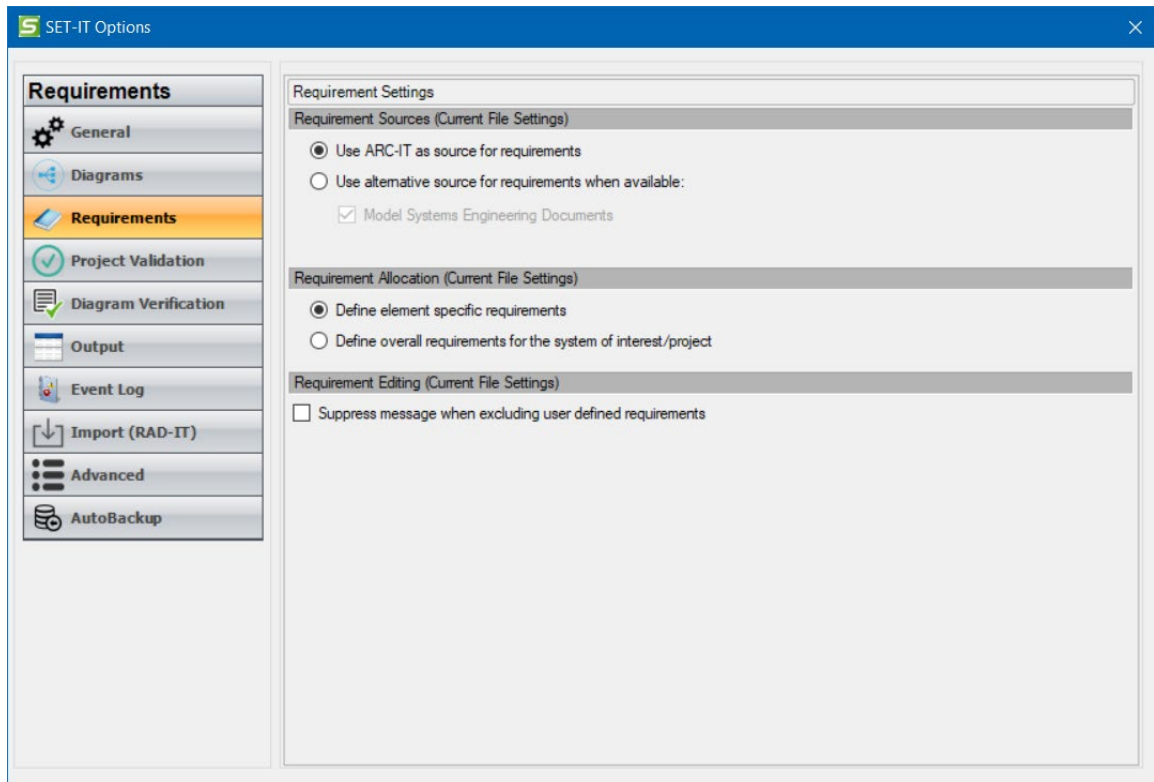

The other set of choices determines how the Requirements Allocation grid will appear in the current project file, either showing functional requirements mapped to each element or showing overall system requirements for the system of interest or project.

NOTE: the Requirement Allocation settings are for the current file only. When you start a new project file you will need to reestablish these settings.

Validation Options

This supports the process of validating the architecture and includes a number of Rules and Options. This screen allows you to establish the default settings to use whenever you run Validation. The Rules

are displayed in a collapsible list with a high-level checkbox for each view and a general set of validation rules:

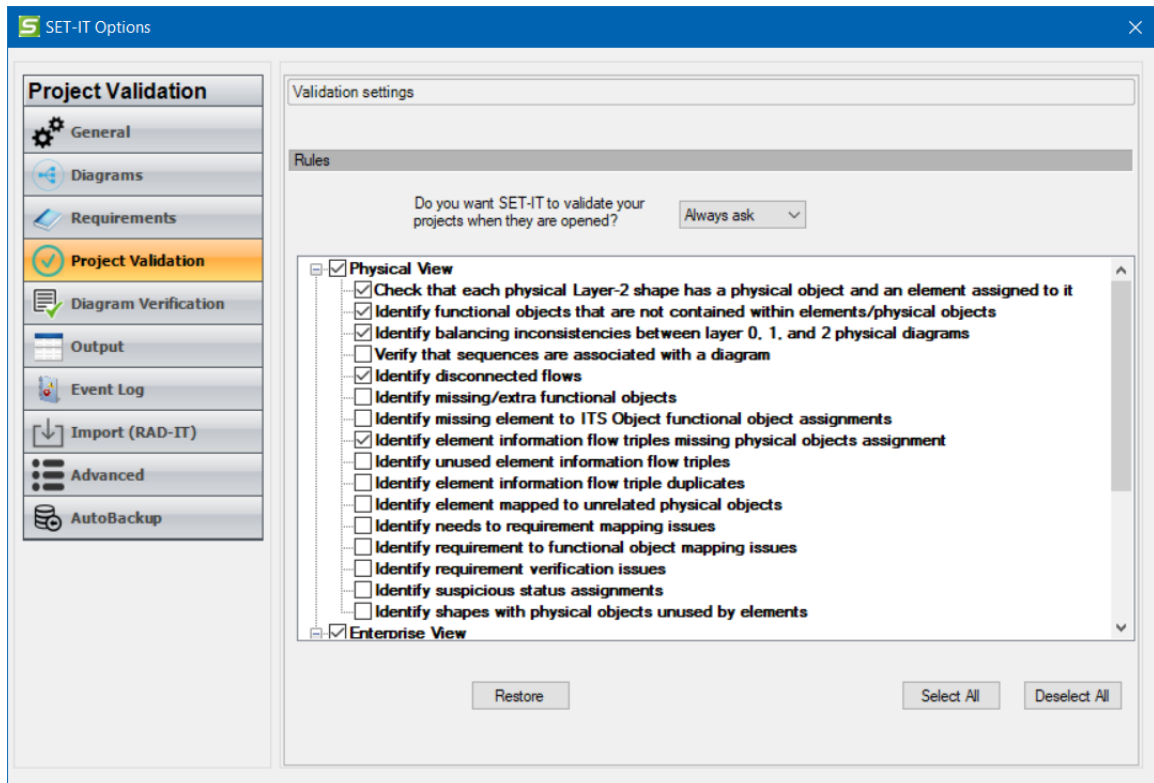

Above the list of rules is a pull-down so you can decide whether you want validation to run every time you open a project or never or tell it to ask you each time.

For more on validation check the [Validation](#) section in the [Review](#) chapter.

Diagram Verification Options

Diagram Verification options supports the process of verifying that a particular diagram satisfies the rules for determining the completeness of the diagram.

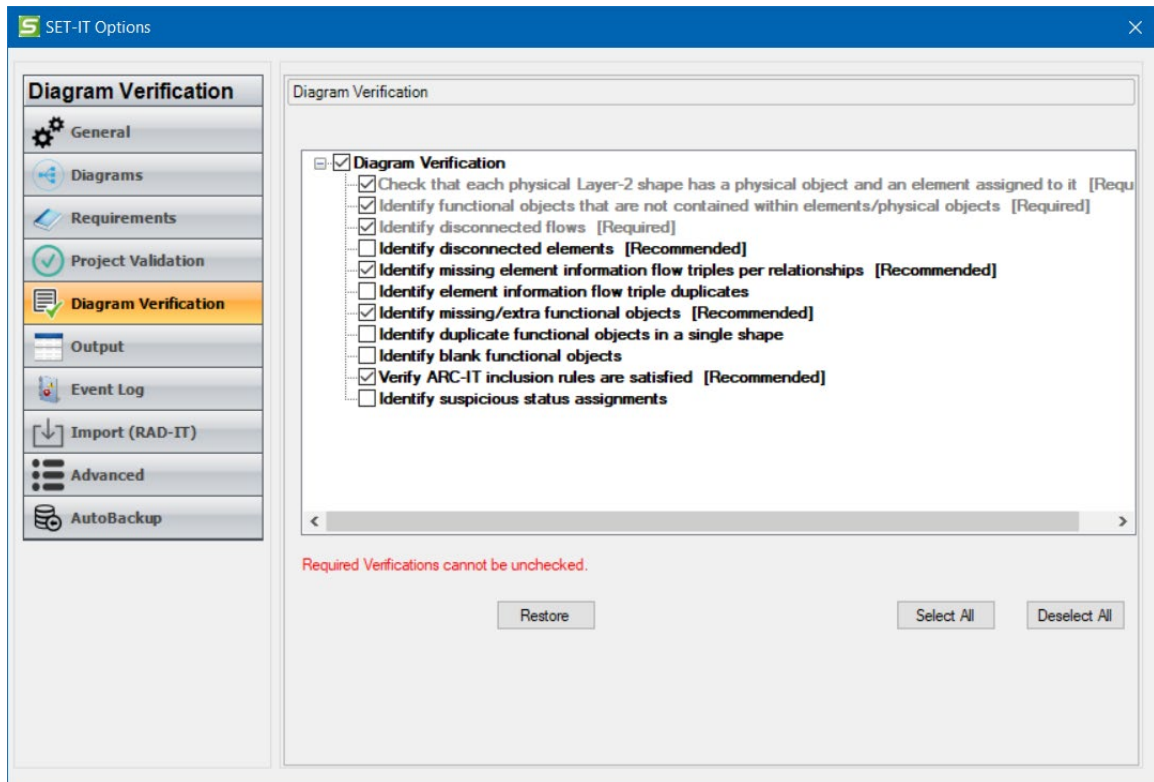

There are several options that can be run every time the Diagram Verification tool is run from the Diagram including some that are required, some that are recommended, and others that are optional. The required tests will be run every time and cannot be unchecked.

The following tests are required:

- That every physical object shape has an element assigned to it
- Any functional objects not contained within a physical object or element
- Whether there are any disconnected flows

The following tests are recommended before completing a project architecture:

- That all information flow triples are included based on the dependency and other relationships defined in the database
- That there are no missing or extra functional objects based on the service package being customized
- Verify that the ARC-IT rules for inclusion are satisfied. This applies to Service Package Implementation drawings that shows some objects and flows as fundamental, some that

maybe part of a set and at least one of that set should be included, and others are optional to that service.

Optional tests include:

- Duplicate information flow triples
- Suspicious status assignments, e.g., flows labeled 'Existing' but its source element is set to 'Future'

These tests will help a user determine if they can consider a diagram as Complete in the development of their project architecture.

A Restore button lets you go back to the Default choices. You can also use the Select All and Deselect All buttons as short-cuts, noting that none of the required tests can be unchecked.

Output Options

These options are used to change how the reports or Output tables will look, including:

1. A set of radio buttons to choose whether your tables include all possible rows from the database or only the rows specifically associated with your project. For smaller, simple projects you may not want to see data on all possible ARC-IT components.
2. A checkbox to roll up (or merge) identical data in multiple rows into a single cell.

TIP: if you have a large architecture you may get better performance if you *Uncheck* that box.

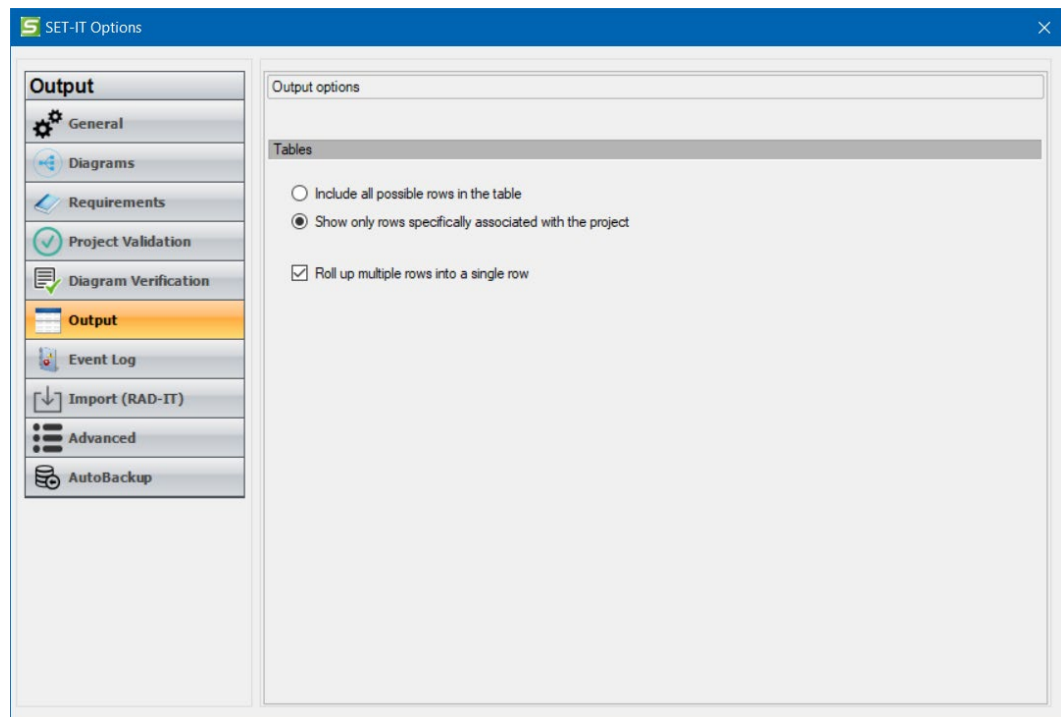

There are two ways to get to the Output Options screen. The first is from the Project / Options menu. The second is from the Output Tables screen. There is a button at the top of that screen called "Options" that leads to this same menu to let you control the outputs as you generate them.

Event Log Options

This screen includes options to turn on/off an event log utility that can be used for debugging errors caused by SET-IT or issues in a project's database or diagrams.

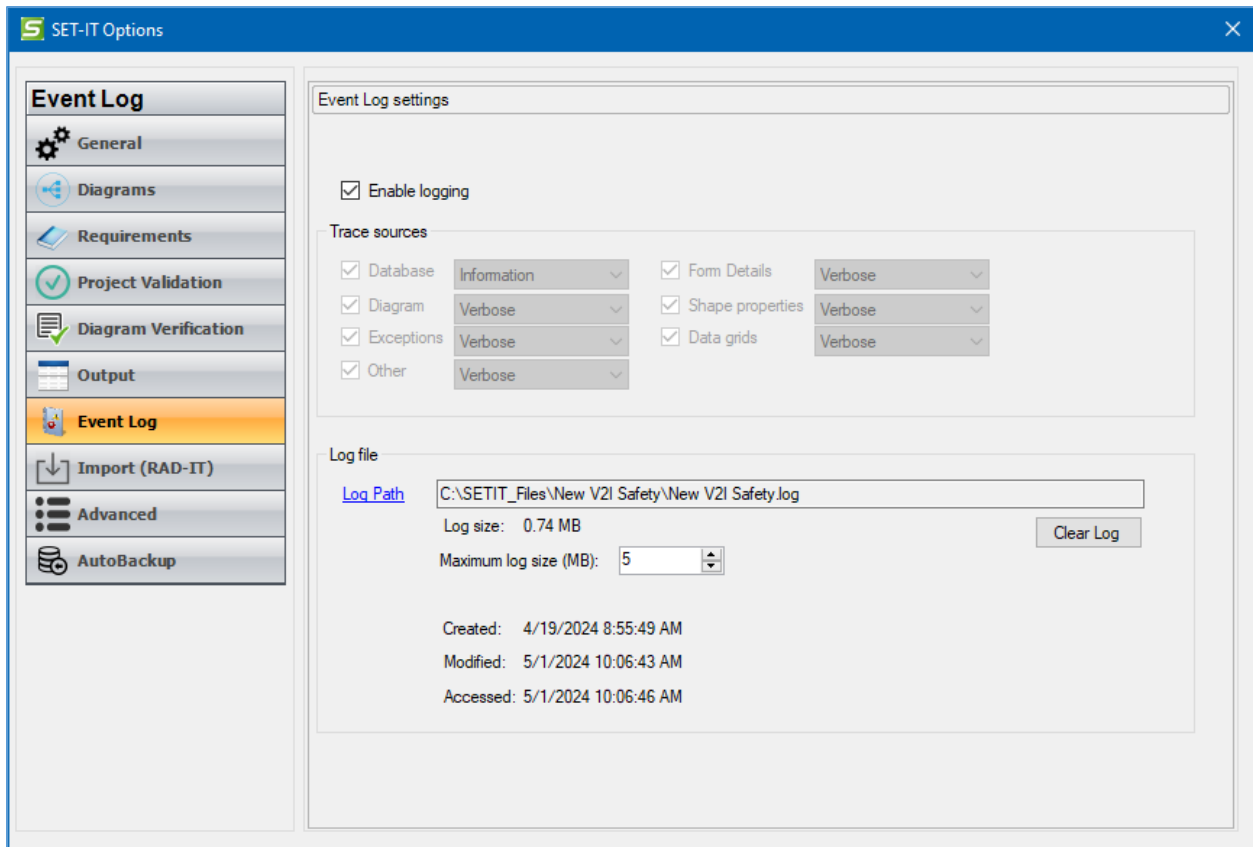

There are 2 sections:

- **Enable Logging** is a checkbox to first turn on the logging capability. Then there are check boxes for the type of error sources to trace: database, diagram, exceptions, form details, shape properties, other. There are pull-downs for each of Information or Verbose.

TIP: It is a very good idea to check this box. If you run into problems or you have a strange error message pop-up, the SET-IT development team will be able to diagnose your problem more quickly if you have this enabled.
- **Log File** – allows you to browse and set the location for the log file to be stored. It will be created in the form of a normal text file. The default path is the path of the current project. You can also set the maximum size of the file. When it reaches the maximum, it will create a

copy and start another file. If it reaches the maximum again then the first file will be copied over. File information tells you when the log file was created, modified, or last accessed.

NOTE: The Trace Sources settings can only be changed if you are running as an Administrator on your computer. Many users can do this when they start SET-IT from the program menu or the desktop. Right-click on the SET-IT icon and select "Run as Administrator..."

NOTE: There is another log file used to capture 'Start-Up' events that happen when a program is started but before a project has been opened or started. This Start-Up Log File is stored on your PC under C:\Users\\AppData\Roaming\Iteris, Inc\SET-IT\. A subfolder is created for each new version of SET-IT and the file is called "SET-IT.log".

TIP: An easy way to find the Start-Up log is to start SET-IT and select Project/Options before you open a project. Go to the Event Log tab of the Options window and click "Log Path" and it will open that directory in a Windows Explorer window.

If you 'run as Administrator' you will then be able to change the Trace Sources options to control how much detail is collected. After you make the changes, you will be prompted to restart SET-IT to apply the changes.

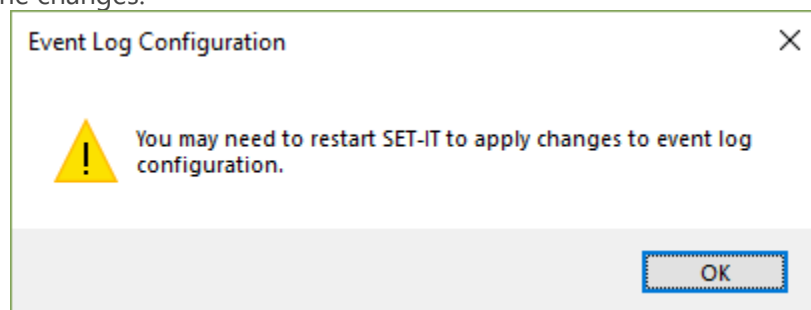

Import Options

When you import a project from RAD-IT you will be given a choice of removing objects that are Not Applicable on the service package diagrams. This will make for less cluttered diagrams but may hide opportunities for future inclusion of objects in a service package.

Here the Options window gives you the option to set a default of:

- Always Ask (default)
- Yes
- No

Advanced Options

The [Temp Folder](#) portion of Advanced Options tab shows you where the temporary files are kept while SET-IT is running.

There may be situations like a system crash where you will need to find these files so you can click the "Path" button to go there. SET-IT normally will clear this folder when saves are done or the project closes normally. However, you may need to manually clear these files if you have had a lot of crashes for some reason and your files are taking up too much space. You can click Export to move the files for offline analysis or you can Clear the files to make room on your hard drive.

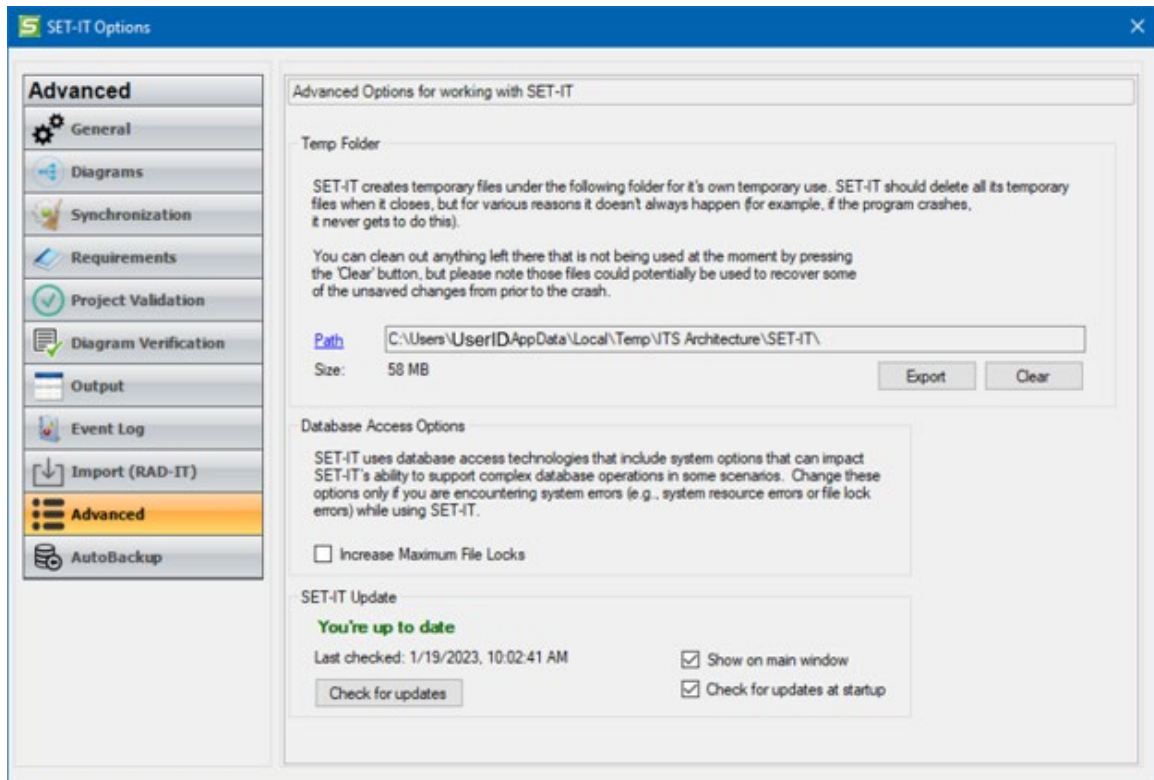

Under [Database Access Options](#), you can change the maximum number of File Locks used by the Database Access Operations. Change this only if you are having issues with system resource errors.

The [SET-IT Update](#) options allow you to manually check the National ITS Architecture website, www.arc-it.net to see if there are updates available for SET-IT. The checkboxes here give you the option to show messages at the bottom right corner of the main SET-IT window or to Check for updates during start-up.

AutoBackup Options

The settings to manage how often, how much, and where the backups are stored are also found on the Project / Options menu – look for the AutoBackup tab.

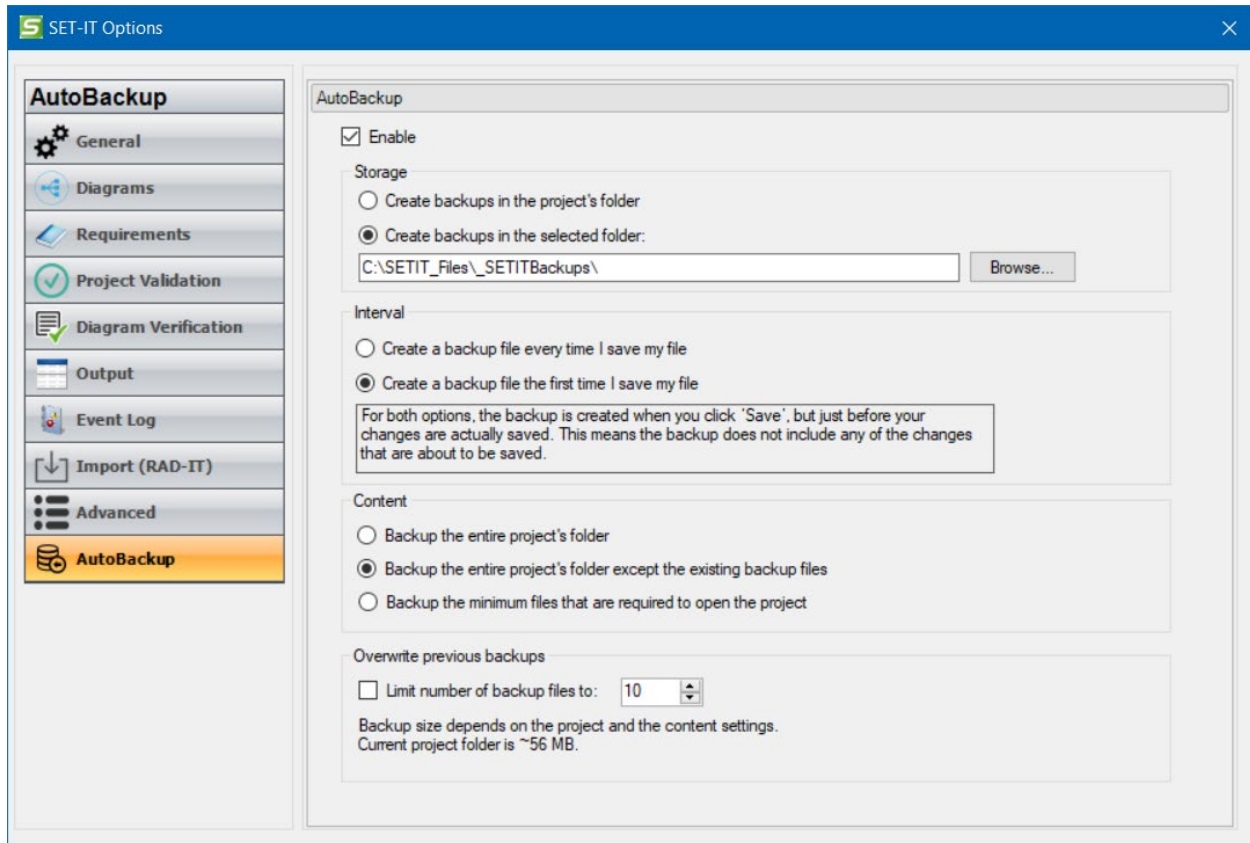

The settings let you assign a specific folder to keep all of your backups in or it will put them in your project's folder. When the backup routine runs it creates a compressed or zipped file and adds a date/time stamp to the filename and uses a unique file extension, ".setitbkg". This file type can be opened by any file compression software.

You can change the interval, or how often backup will run; every time you do a Save or in conjunction with opening your project. As the note says on the screen, for both options the backup is created when you click 'Save', but just before the changes are actually saved. This means the backup does not include any of the changes that are about to be saved. The idea is to make a backup of the state of your project just before committing any of the most recent changes to the permanent saved database. This may be useful when there is a problem and the database gets corrupted.

You can also set how much is backed up. Remember that a SET-IT project is a collection of files including the database, the Visio drawing files, the log files, and the ConOps templates. You may also have copies of your generated diagrams and other outputs in the folder as well. AutoBackup can back up everything or just enough to open the project – the database and drawings – which might be OK if you're using this as a way to restart the project if you have a problem and you are storing the more complete project backups on your own somehow.

The settings for AutoBackup also let you set how many backups to keep. If you're backing up the entire project folder every time the files can really add up so you may want to limit the number of backups it keeps.

See [AutoBackup](#) described in the [Save a Project](#) section for more information.

Searching My Project

Once you have a project with lots of diagrams it may be hard to remember where everything is and what is on each diagram. Use the "Search" box at the top of the SET-IT screen. This box also has a pull-down arrow you can choose to open a Find & Replace feature.

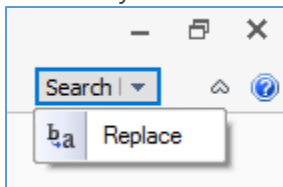

In the Search or Find/Replace window simply enter the word or phrase you want to look for in the box and click search.

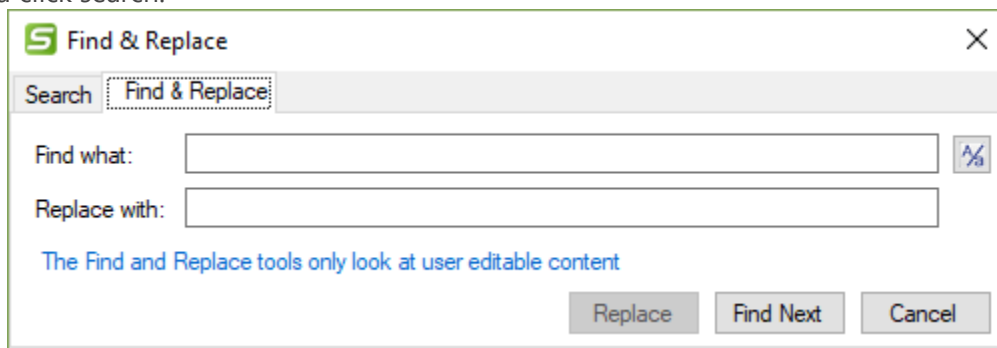

SET-IT will open a new form showing the Search Results.

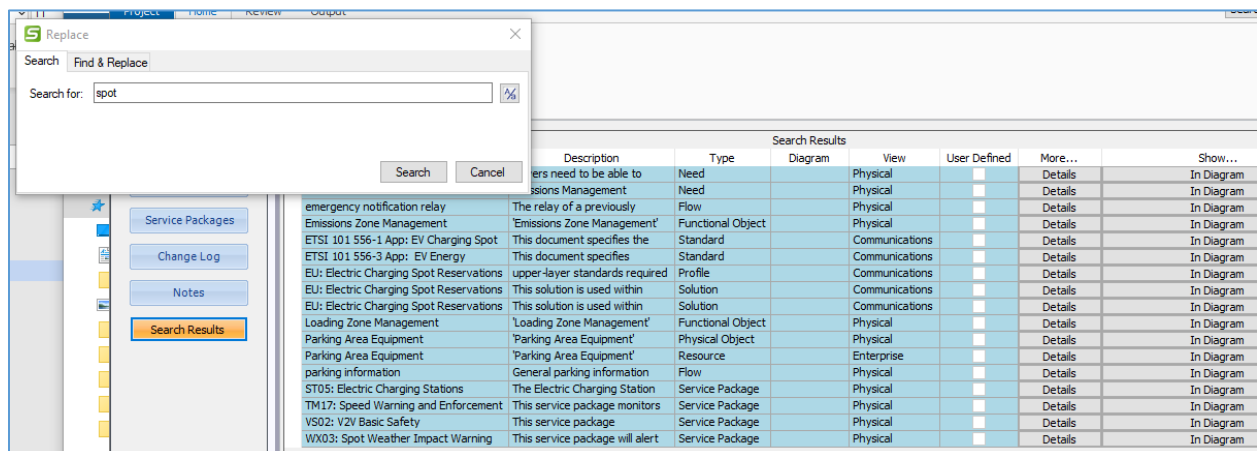

Each row lists the object within the architecture that contains that word – either in the name or within a description. Click on the “Details” button to see the definitions details form or click on “In Diagram” to open the diagram that has that flow, resource, element, or object.

You can search for something again by clicking the down arrow and cycling through your search history. This is useful if there are key phrases you typically search for.

You can select the Find & Replace tab and enter a phrase to change from and to across your architecture. As you press Find it will open the Details form where that phrase is found, either in the name or description. Press Replace to make the changes and then select Find Next to find the next occurrence of the search phrase.

In either tab you can use the Case Sensitive button to toggle between whether to search or find phrases exactly as entered.

Another way to Search is to use the Search feature at the bottom of the Overview / Service Packages screen to search for key phrases among the ARC-IT service packages.

Diagrams & Architecture Components

SET-IT uses a combination of Diagrams and Database Tables to represent a project architecture. The project architecture is also expressed from different Views.

Common Usage Notes

SET-IT makes use of Microsoft Visio to provide the underlying drawing surface and many of the tools to draw and edit your project diagrams.

When you select a Service Package from the Overview menu you are selecting information from multiple aspects of ARC-IT (formerly National ITS Architecture & CVRIA) including physical diagrams along with definitions of the architecture components that make up the physical and enterprise views. Communications View includes definitions for the standards and the protocol profiles. There are also the templates used to draw each of the communications view diagrams. This also copies over the Needs and Requirements for that Service Package as defined in the Architecture.

Switching between Views is accomplished by selecting the view from the menu bar or ribbon:

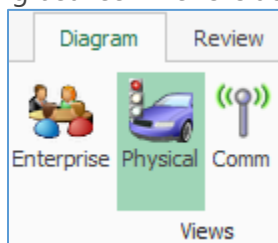

SET-IT will try to switch you to the appropriate place in the other view and remember where you were so you can switch back. For example, if you are in the Definitions grid and are looking at a list of Stakeholders while in the Physical view when you select the “Enterprise” button SET-IT will take you to the Stakeholders table on the Enterprise view. Switching between Enterprise and Physical diagrams works the same way allowing you to easily flip back and forth between the enterprise and physical views of the same service package.

Some common issues you may encounter on any type of diagram:

- **Disappearing Stencil?** On the diagrams it is possible for a user to right-click at the top of the Stencil area and it will activate the Stencil context menu. One of the choices is to Close or Hide the window which removes the stencil completely from the user interface. If this happens and you want to use the Stencil, you will need to Close SET-IT and restart it.
- **Red Asterisk?** You may notice a red asterisk appear in the Stencil area next to Physical Stencil. This indicates that Visio has the stencil in Edit mode and you may be able to see other options. There is no cause for concern. SET-IT has the stencil in Read-only mode to prevent any permanent changes.
- **Ctrl-g?** Pressing the Control key and the g key or <Ctrl-g> is a way to “Go To” a certain location or position within a Word file. In Visio it is a shortcut to “grouping” several shapes together. Unfortunately, in SET-IT this has had unpredictable effects. If you use your mouse to click and drag a box around several shapes and click <Ctrl-g> you will get a warning message that “SET-IT does not allow shape grouping. The grouped shapes will be automatically deleted. ‘Undo’ can be used to recover the deleted shapes.”

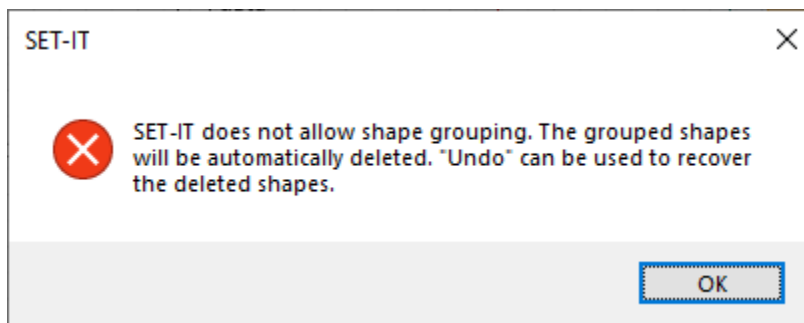

You will see the shapes you had selected disappear and you should click the Undo button immediately to restore your shapes to the diagram. Because of this it is recommended that users do not use <Ctrl-g>.

Undo: You may notice that clicking Undo or pressing <Ctrl-z> does not have the effect you wanted. Sometimes you may have to click it again. In some cases, Undo will have no effect – for instance, if you added a functional object to an element and requirements were automatically added to the element then Undo may not automatically remove those requirements. You may have to go in and manually adjust the requirements.

Visio: SET-IT is designed to work with 2013 or 2016 versions of Visio. It has also been tested with 2019 and 365. However, if your other Microsoft Office products have been upgraded to 2016 or

higher than Microsoft now requires that your copy of Visio also be upgraded in order for the tools to talk to each other – which they do when using SET-IT.

Completion Status: You can right-click over the name button for a diagram in the left menu and assign a Completion Status of Started, Partial, or Complete.

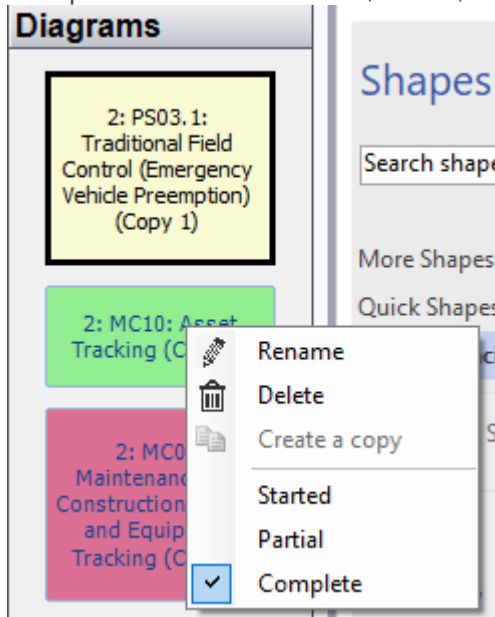

The color of the button will change accordingly so you can see at a glance how far along you are.

- Pink/Red = Started
- Yellow = Partial
- Green = Complete

These values are manually assigned. SET-IT isn't keeping track of what you've done and setting the values for you. This is just a way to help you and your stakeholders see the status. If you set it to Complete, then SET-IT will run a series of test to verify that you are at least minimally complete.

Then you can use the grid for Diagram Information to add a note about this Completion Status.

Physical View

The architecture's physical view is where most of the work takes place to define the system elements and interfaces for an intelligent transportation system project. The other views will build on this section which describes how to create and modify your architecture's physical view, including how to create a new Physical diagram and modify its components.

Including a Service Package

When you start SET-IT and create a new project you use the Overview screen to fill-in that project's information. The next step typically is to select a Service Package to include in your architecture as the starting point for your project. Click the Service Packages button on the Overview menu.

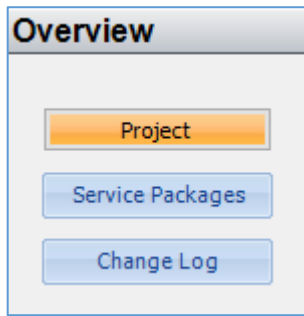

You are then shown a list of all of the Service Packages in ARC-IT. See [Select Service Packages](#) for more on this.

You can use the search box at the bottom of the screen to search for a particular service package based on key words or phrases like “transit” or “security”.

As you highlight a row you will see the description and diagram for that service package appear in the right side of the screen.

Click one or more checkboxes and the “Include” button at the bottom and SET-IT will import those diagrams from the ARC-IT library into your project along with the database descriptions of the service package, objects, and flows.

The next step will be to customize the drawing by creating and assigning locally named Elements to the Physical Object boxes and making other customizations described in the next sections.

NOTE: Some users have reported that as some drawings are imported into SET-IT boxes show up with just a white box and no color to represent their class. This appears to be a resource issue on the user’s computer. Delete the diagram and try again.

Create a New Physical Diagram

1. Click on the **Diagram** button from the new area of the menubar (top-left).
2. Select a **Layer** from the drop-down menu. For Physical the choices are 0 for the project level perspective, 1 for mid-level perspectives, and 2 for the service package level.
3. Enter a name for the diagram in the **Title** box.
4. Select a **Service Package** from the drop-down menu. This creates a database entry to associate this diagram with a particular service package / application. (NOTE: at this point this is optional as it doesn’t pull in objects from ARC-IT to draw the diagram it simply creates a database relationship.) It does allow you to select custom or user-defined service packages created on the Service Packages table from the Definitions menu.
5. Click **OK**.

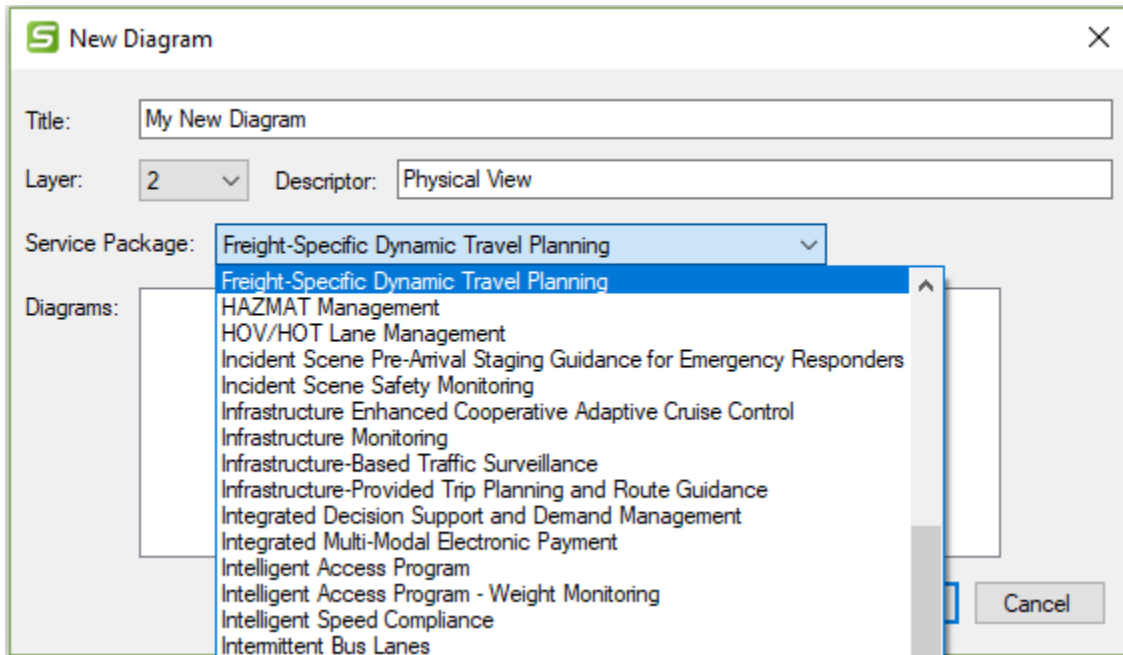

You can choose from the ARC-IT service packages or a new user defined service. Any user defined service packages that have been created in this project architecture file will be listed first. You can add a service package by selecting <New Service Package> from the Service Package pull-down which will open the New Service Package window. See “Creating [New Items from the Ribbon](#)” for more information.

NOTE: You cannot create a copy of a Physical Layer 2 diagram directly from the Diagrams menu (go back to the Overview / Service Packages screen to include another instance of the Service Package).

Add a Shape to a Diagram

To add a shape to a diagram, start by creating a New Diagram, or opening an Existing Diagram. Select a **Shape** from the stencil on the left.

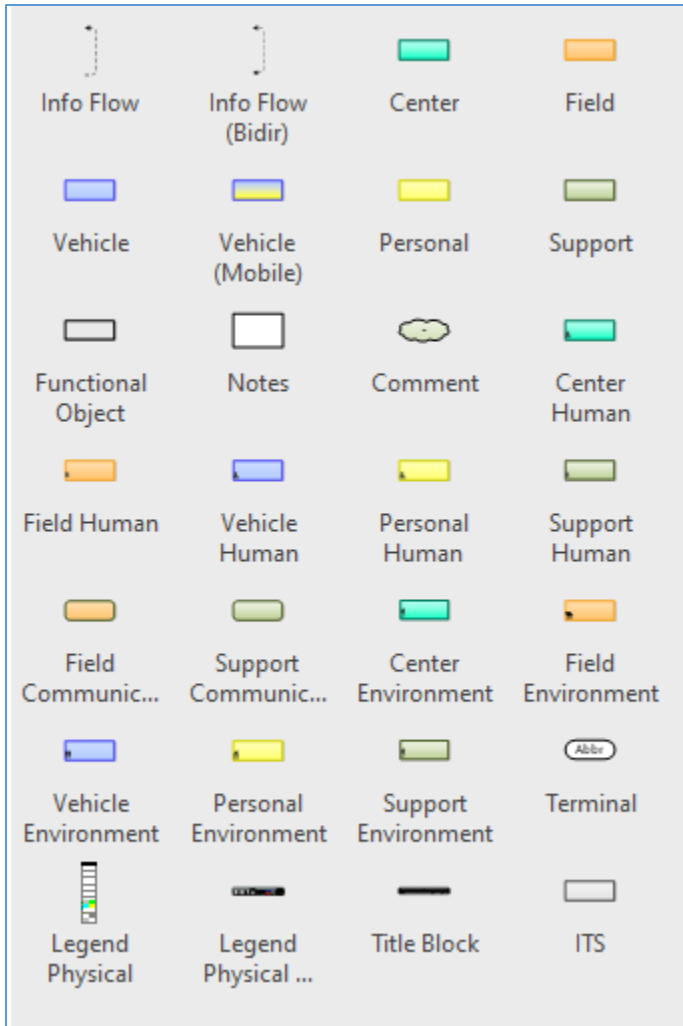

Shapes include Information flows; Physical Objects – either Center, Field, Vehicle, Vehicle(mobile) which is a nomadic device like a smart phone that could be carried into the vehicle and turned into onboard equipment, Personal, or Support; Functional Objects; Notes or Comment boxes; Human objects (operators or users) – either Center, Field, Personal, Vehicle, or Support; Communications objects like Data Distribution Systems or Wide Area Information Distribution systems; Environmental objects of various classes; Terminals; Legend (vertically or horizontally oriented); or a Title Block.

The ITS Object is used for the Location and Time Data Source objects if you need to add one to your project. Otherwise, the ITS Object works behind the scenes to represent a generic object supporting all of the subsystem kind of elements in order to include their common functionality and interfaces. The user will not have to select ITS Object. SET-IT will decide when to include that mapping for you.

Drag the **Shape** to the drawing area.

Double click on the Shape or right-click and select **Shape Properties** to view and edit the properties of that new shape.

For Physical Object and Communications boxes select the physical object down in the bottom part of the Shape Properties.

Click **New** to create a new element mapped to this physical object or communications shape. If an element already exists for that PObject you can just click to select and map that element to this new shape.

Delete a Shape

Select a **Shape** in the drawing area by clicking once on the shape.

Click **Delete** on the keyboard. It will ask if you are sure.

You can also right-click and select Delete.

If you delete a user-defined Physical Objects you will be informed with a pop-up screen that an Enterprise Object / Resource by that name also exists and you will be asked if you want to delete that, too. Conversely, if you delete a user-defined Resources in Enterprise view, you will be informed that a Physical Object by that name also exists and asked if you want to delete that, too.

Create an Element

An "element" in SET-IT represents an instance of a physical object from ARC-IT. Think of this as the local or customized version of what the national or reference framework has defined.

You can create your own elements and associate them with one or more physical objects.

There are several ways in which to create an element:

- From diagram, double-click on one of the rectangles that represent a physical object. This will open the Shape Properties window shown above. From there select New... to open the Element Details window.
- From the 'New' area of menu bar on the "Home" ribbon, select Item / Element. This will also open the Element Details window.
- From anywhere in the Physical or Enterprise view press Control-e which is a shortcut key to open the Element Details window.

When starting with the Shape Properties window you will first select the appropriate **Physical Object** from the checkboxes located on the middle of the form.

If you dragged a system shape onto the diagram and opened Element Details using the New or Edit buttons on Shape Properties then certain fields will be locked. Use Shape Properties to make those changes first.

Select the **Type** – System or Human. This will be established by the shape you chose to move onto the drawing.

Select the **Domain** – Transportation or Communications. This will narrow the choices available on the other pull-downs. If you select Transportation then only transportation related PObjects will be available for selection and if you select Communications then only communications related PObjects will be available, e.g., Data Distribution or Wide Area Information Dissemination.

Select the **Class** – Center, Field, Personal, Support, Vehicle

Select the appropriate **Physical Object(s)** from the pull-down menu to select an ARC-IT physical object or a user defined object. SET-IT will filter the selections based on the domain, class, or type of object.

Select from an existing element in the center of the Shape Properties window.

Once you have selected an element to associate with this shape you can select its status. It will default to what you have set as the Default on the Status Values table (see Status Values in the [Definitions Menu](#)), usually "Project".

If you don't see an element listed, click the **New** button in the shape properties form.

The **Element Details** form appears as shown below:

Form Source: New Element

NOTE: the Lock symbol beside Physical Object(s) will appear when you come into Element Details from Shape Properties. This is preventing you from changing something that is based on a diagram. You would have to make the change on Shape Properties first or from the Definitions grid.

Type an **Element** name and its description and the selected **Element** name will appear on the shape.

A default abbreviation will also be entered in the Abbreviation box but you can change this to something that makes more sense to your stakeholders. This is limited to 5 characters so they fit on the terminal shapes when those are used. If your name is more than 5 words long, it will stop after 5

characters. If the automatic abbreviation will cause a conflict with an existing abbreviation, then the last letter will be replaced by a number.

You can type in a **Description** for the element. If you don't quite know what to say use the "**Auto-Populate**" button to the left of the Description box to let SET-IT create a Default Description. This will copy the descriptions of the physical object(s) the element is mapped to from the ARC-IT database. Then you can customize it.

Center/Field and ITS Object:

When you clicked New from Shape Properties there may have been additional Physical Objects mapped to your element behind the scenes. SET-IT automatically associates your element with the generic physical objects that are appropriate to the kind (subsystem or terminator) and class (center, field, personal, or vehicle) of object you are creating. These class-level or level 1 objects are set automatically by SET-IT so the element will inherit the functions and interfaces that are common across all systems of that class. Elements mapped to a subsystem (an object that has functional objects) will get assigned an ITS Object mapping and the Center, Field, Personal, and Vehicle class elements will also get a Center, Field, Personal, or Vehicle object assignment, respectively. This will be visible in the Element Details form or on Shape Properties only if you checked the option on the Diagram Settings options to "Show class level physical objects".

The exception to this is any ITS Communications Equipment elements which are not automatically mapped to either ITS Object, Center, or Field physical objects. These general objects provide functionality across all the objects in this class, including security, management, and communications. This simplifies the overall architecture so these functions and interfaces do not have to be defined multiple times.

Human Objects:

The figure below shows the Details form when creating a 'Human' type of element:

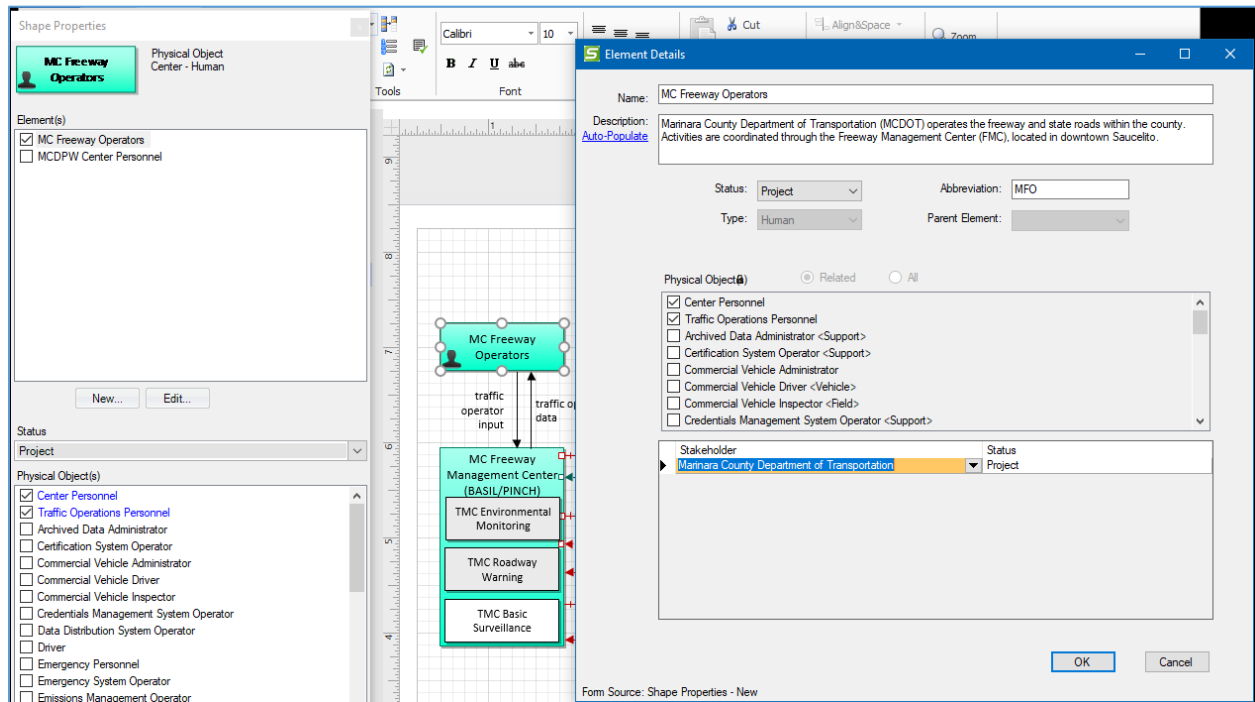

When you edit the details of a Human type of element the 'class' of the object is not shown. When you create or edit the element details from the Definitions menu you can associate it with more than one physical object from different classes. This allows you to support situations where the same element, City Centre Traveling Public, may drive but they may also use other modes of transportation such as a transit vehicle so you want to show them as both a Driver (vehicle class) and a Traveler (personal class).

The other feature of the Element Details form is to associate the human element with a stakeholder. This is a variation of the normal Element Details form in that the Roles column is not shown. You can either enter a stakeholder to associate a stakeholder/human that may be managed or be part of a larger organization – such as a Taxi Driver that is part of a Taxi company. You can also leave the stakeholder field blank for the Human element and SET-IT will automatically create a stakeholder with the same name as the element. This will let you show the relationship between the stakeholder who may operate or use an element with other stakeholders (owners, managers, etc.) in the Enterprise view.

Element Creation Notes

NOTE: the ability to change an element's mappings to physical objects is disabled when you enter the details form from Shape Properties on a diagram. In that case, SET-IT is restricting controls to only what is on that diagram. You can access the Element's definition from the Definitions menu and change the mappings there with some restrictions. If you try to remove a physical object mapping in the Elements

Details form you may see a message that says, "To unmap this physical object from this element you must first remove it from this element's shapes on the following diagram(s): ..." Go back to the Diagram and use Shape Properties to change the elements and how they are assigned to different shapes on the diagram.

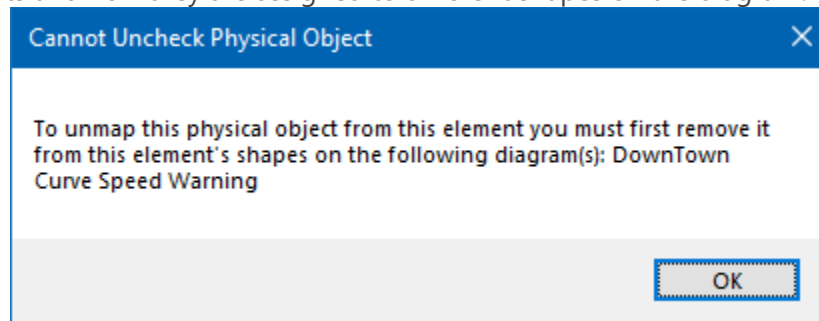

CAUTION: If you enter the Element Details from the Definitions menu you can also change the **Class** of the object with the Class pull-down to either Center, Field, Personal, Support, or Vehicle or the **Type** of the object to either System or Human. A warning will pop-up to say "Changing the Element's Class will uncheck physical objects currently assigned to this element. Do you want to proceed?"

This can have big consequences later so you may want to leave this assignment alone. If you have something that is part of multiple classes, go back to the diagram and choose one of the hybrid objects from the Stencil.

Next, you can also use the area below the physical objects list to enter **Stakeholders** for the various **Roles** and their **Status** with that element.

TIP: It is a good idea to make sure your elements have a stakeholder for who *owns* and *manages* the element. This will help SET-IT map out the relationships among Stakeholders. This will be exercised more with the [Enterprise View](#).

NOTE: You can assign multiple stakeholders to a role depending on their status. You may define one stakeholder who is currently operating a system (Existing status) and another stakeholder that will be operating the upgraded system once the project is implemented (Project status). However, two stakeholders cannot have the same role and the same status. No two stakeholders can operate a system at the same time.

When you are done select **OK** and the selected **Element** name will appear on the shape on the diagram. Now as you edit other diagrams for other service packages you can reuse this Element for similar physical objects.

The other way to create a new Element is to use the New pull-down menu from the Home or Diagram ribbon.

NOTE: If the new element is a *center* type of element, when you say OK to create the new Element, SET-IT will automatically associate the element with the generic "Center" physical

object. This will allow you to assign generic interfaces to your element such as system monitoring or permissions data.

NOTE: If the new element is a *field* type of element, when you say OK to create the new Element, SET-IT will automatically associate the element with the generic “Field” physical object. This will allow you to assign generic interfaces to your element such as field equipment status or configuration settings.

Creating a Complex Element

Is it possible to create an element that is mapped to multiple types of physical objects? Yes, you can. In most cases, elements should stay mapped to objects of one class (center, field, personal, support, vehicle) but there may be times when you have an element that is more complex, e.g., a center that is also doubling as your traffic data archive, or a mobile unit that has a piece of field equipment mounted on the back.

In those cases, open element details from the Definitions grid or from the menu when you create a new element. In the Physical objects area, click the “All” radio button on the Element Details form. That will expand the list of physical objects to show you all of the possible physical objects of the same type and domain. Type is either system or human and Domain is either transportation or communications. You cannot map a transportation system to a communications system, and you can’t map a system element to a human, either.

The list of PObjects will also change to show the class of the physical objects if they are different than what was already selected in the Class pull-down above.

Creating Communications Elements

Communications Elements are used in a project to represent the flow of information *through* a set of devices or infrastructure like fiber or cable or an entire communications service and you want to show how that element/set of devices will be implemented and maintained. Another type of communications system specializes in the collection, storage, and distribution of data.

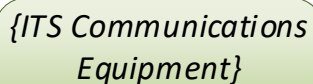

***{ITS Communications
Equipment}***

In SET-IT communications objects are of a support class and are shown on the diagram with rounded corners to indicate they are different than the transportation and other system objects.

Because Communications objects are of a different class they typically cannot be mapped to one of the Transportation class elements. An exception to this is the Transportation Information Center (TIC). It can also be mapped to a Data Distribution System (DDS) physical object since they are often done by the same stakeholder system or center.

But note that it does not go the other way – a DDS cannot also be mapped to a TIC.

Remote Access Device

Center or Support elements can have human operators that interact with the center or support system element through a Remote Access Device (RAD). The connections will be using a device like a personal computer or other device that connects to the center or support system through a secure encrypted connection. In SET-IT a Remote Access Device can be created as a Personal class element and then assigned to a Center/Support to Human element flow as a Communications element.

As you assign a RAD to one flow in one direction the other flow will also be assigned to match.

Creating a Child or Instance of Another Element

There is another type of element – an Element Instance. These are elements that inherit many of their characteristics from another 'Parent' element. This is used to define a general element, e.g., ITS Field Equipment, for perhaps a regional or larger scope project and then in later activities/phases break down the parent or general element into specific instances, e.g., Surveillance CCTV Cameras.

To create an Element instance, use the New Elements menu Item to open Element Details. Provide a **name** and click the pull-down for "**Parent Element**" and select one of the elements already create.

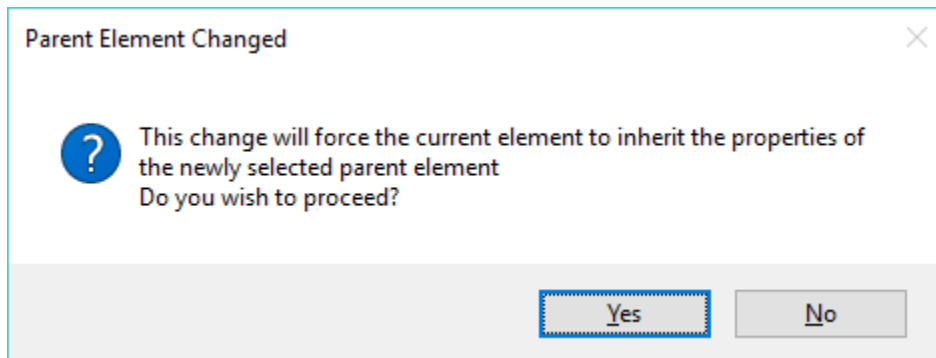

Be careful – this warning gives you a chance to make sure that's what you want to do. For instance, think twice before you start with a field device but accidentally picked a center as the parent. Say no and go back and correct your mistake.

Say yes, and the new Element will be created with the PObject assignment of the parent element and a copy of the parent's description that can be tailored to the instance.

You can reverse this – you can turn an Element Instance back into a regular instance simply by going to the Parent Element pull-down and clicking the top, blank row.

The idea of Element Instances is good when creating sub-projects that use more detailed versions of the general elements for parts of the project. This feature also sets up compatibility with the RAD-IT Tool which has used parent/instances for a long time to distinguish between regions and projects.

Adding a Physical Object to a Diagram / Assigning Element

These steps will show how to work with the diagram to add a physical object to a diagram that will then be mapped to a local or customized Elements. This is based on a set of predefined physical objects that came from ARC-IT. You can also add your own custom, unique, or user defined Physical Objects if ARC-IT does not have what you need. Go to Creating a New Physical Object in the [Creating New Items from the Ribbon](#) section.

Now, back to the diagram and the physical shapes – Start with a New Diagram, or open an Existing Diagram, then Select one of the 6 different **Physical Objects** types from the stencil on the left.

Physical Objects come in ‘classes’ based on how they are defined in ARC-IT. The Physical Object Classes are:

- Center
- Field
- Personal
- Support
- Vehicle

A 6th class known as the ITS class is really a higher level of the physical view’s hierarchy and is used to represent common functions and interfaces that all ITS objects share, including system management, communications, and security.

SET-IT also lets us show the **human** operators of the various objects in a different box to show that it is a human-to-machine interface.

The **Nomadic** or **hybrid** type of Physical Object represents a combination **Vehicle (Mobile)** object. It’s really a Vehicle class but might support vehicle safety or mobility service packages that run on a personal mobile device and may, in some cases, connect to the vehicle databus, when they are driving.

To create a new physical object, drag the **Physical Object** shape from the Stencil to the diagram area.

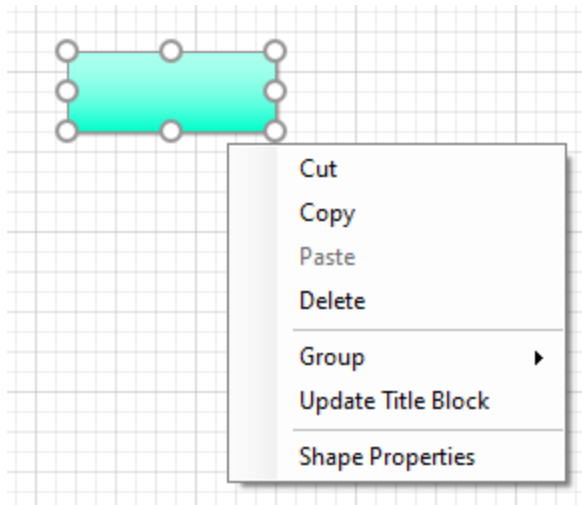

Double click on the **Physical Object** shape or right-click and select Shape Properties.

The **Shape properties** form appears.

Physical Object menu is on the bottom of the **element Details** form.

Shape Properties

Physical Object Center - System

Element(s)

New... Edit...

Status

Physical Object(s)

- Alerting and Advisory System
- Alternate Mode Transportation Center
- Archived Data User System
- Asset Management System
- Authorizing Center
- Border Inspection Administration Center
- Care Facility
- Commercial Vehicle Administration Center
- Commercial Vehicle Service Provider Center
- CVO Information Requestor Center
- DMV
- Emergency Management Center
- Emergency Telecommunications System
- Emissions Management Center
- Enforcement Center

Shape Properties

Select the appropriate **Physical Object(s)** from the checkboxes located on the bottom of the **Shape Properties** Form. SET-IT preselected the physical objects to list here based on the Class and Type of box you brought in from the stencil.

If elements have already been created to match the checked Physical Objects, then the selected **Element** name will appear in the top area of the shape properties window.

NOTE: The Shape Properties box will be 'floating' to the left side of the window when it first opens. To re-dock it simply click the title of the box and drag it over 'drop' it over the icon that looks like a closed door on either the left side or right side of the screen. You can 'undock' it by clicking the title of the box and dragging it to another area of your screen. You can also simply close the Shape Properties by clicking the X button in the top right of the window.

NOTE: The *human operators*, including drivers, are shown on the physical view drawings as physical objects with an icon of a person in the corner of the box. Human operators are also *stakeholders* so as you create and edit a Human Operator on the physical diagram you are creating and editing an element and a stakeholder at the same time. Human elements / stakeholders also correspond to Resources in the Enterprise View. So, if you create a new, user defined human element then SET-IT will automatically add that to the list of Enterprise Objects you can use in the Enterprise View.

NOTE: The *environmental terminators*, including potential objects or vehicles detected by sensors, are shown on the physical view drawings as physical objects with an icon representing what is being sensed in the corner of the box.

If no elements have already been created matching the selected Physical Objects, then click the New... button to create an Element. This will bring up the Element Details form. See "Create an Element".

Once an Element has been created or selected Shape Properties can be used to set the Status value for that element if your display is set to show Status.

Adding a Physical Object Mapping

This section discusses what happens when I change the physical objects assigned to an element shape on a diagram that is already assigned to one or more Physical Objects.

In the scenario shown Below, a user has brought up Shape Properties for the MC Freeway Management Center (BASIL/PINCH) element. Shape Properties indicates that the shape is currently mapped to both the Center and Traffic Management Center physical objects. The user has clicked on the box next to the Asset Management System physical object to add that as an assignment for this shape. A dialog box called "Element Update Confirmation" appears asking the user, "Do you wish to add this physical object mapping to the elements currently mapped to this shape as well?" The choices are Yes or No with an option to "Remember my choice and don't ask me again."

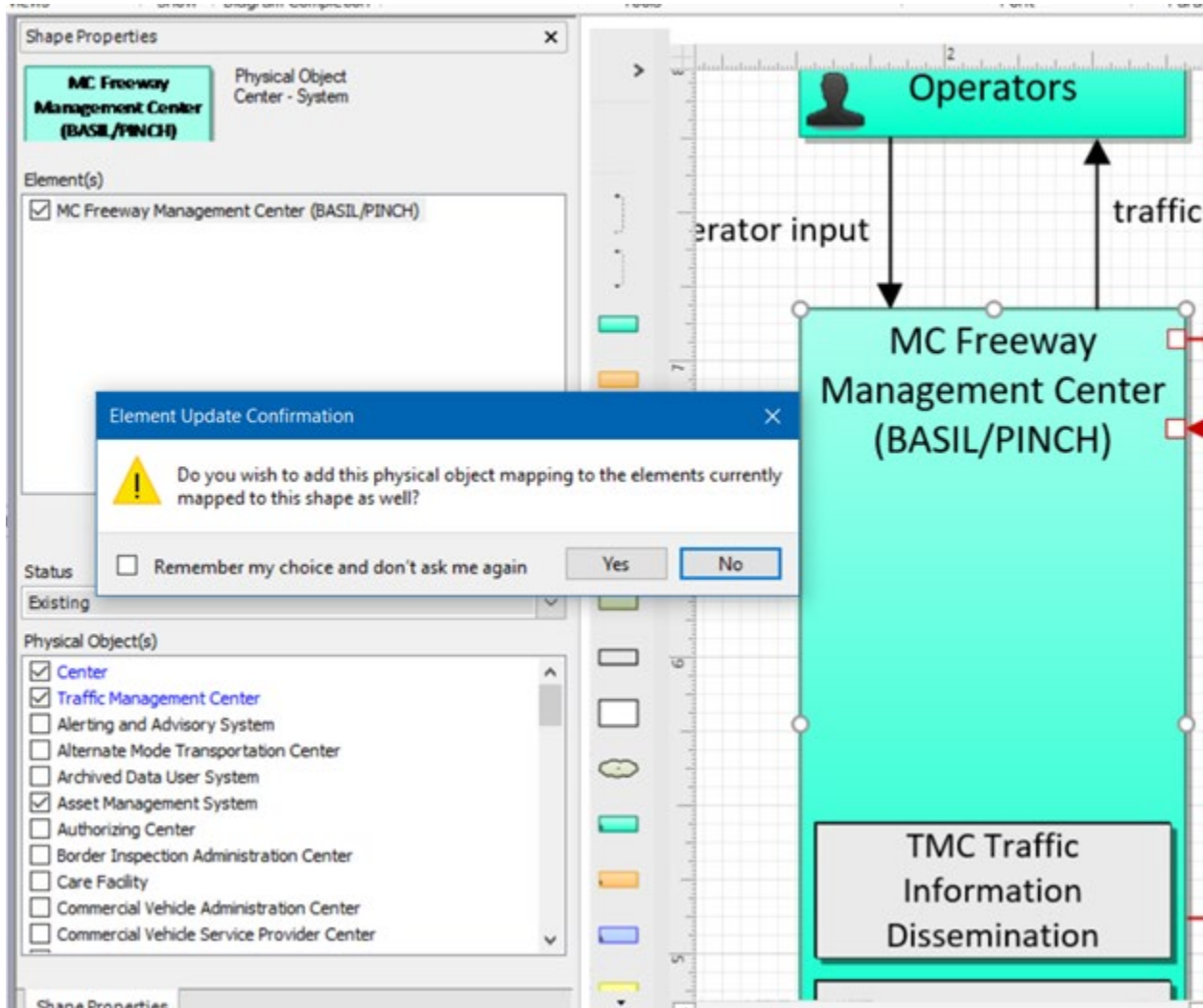

Saying Yes here will change the mapping of physical objects for any and all elements shown in the Elements area of Shape Properties. You will be able to see and confirm this new mapping by clicking Edit to bring up Element Details and see that it is now mapped to three physical objects: Asset Management System, Center, and Traffic Management Center.

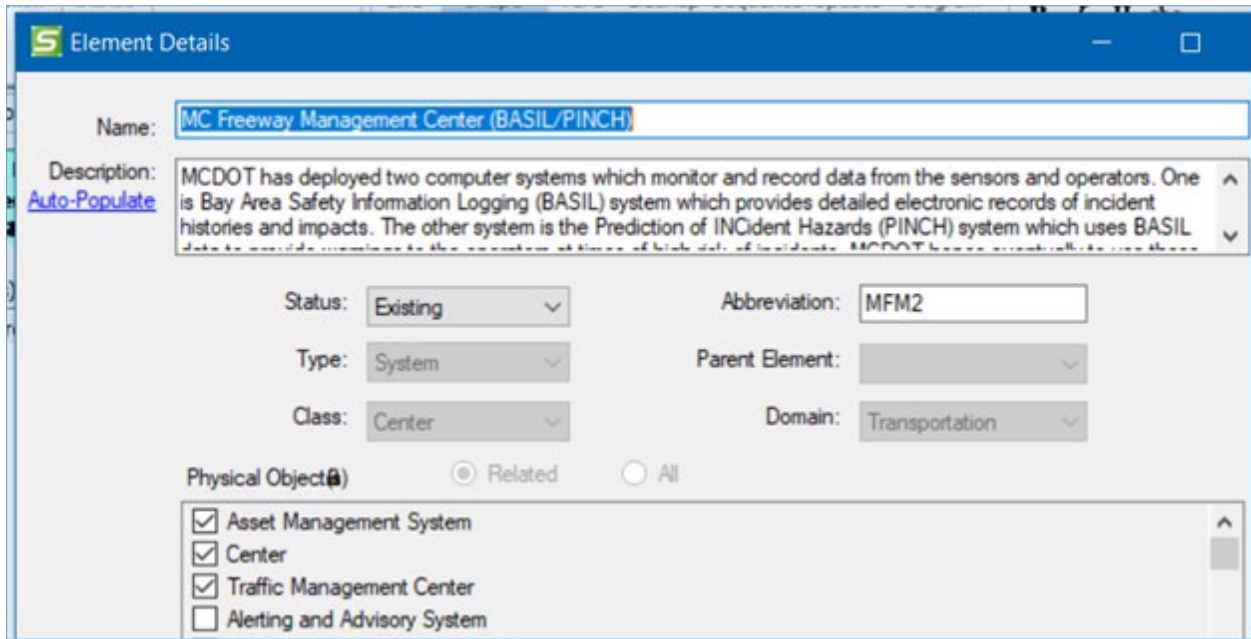

If you had clicked No then the element would have retained its mappings to just the Center and Traffic Management Center physical objects but the shape would have had an additional entry – Asset Management System.

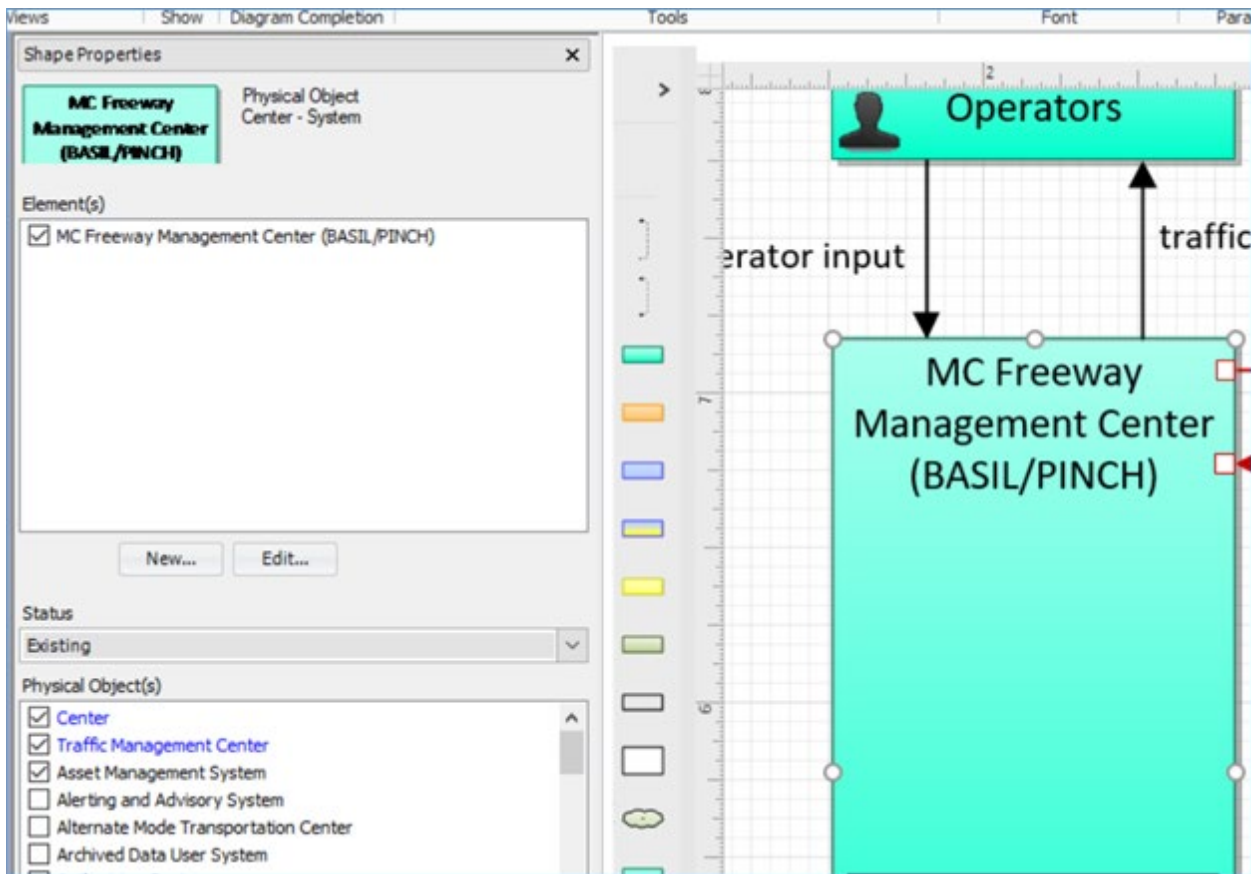

NOTE: the use of color in the screenshot above. The first 2 – Center and Traffic Management Center are blue to indicate that they are both assigned to the shape and the Elements shown. The Asset Management System has a checkmark also but it is black indicating that it is mapped to the shape on this diagram but not to the elements assigned.

At this point, if a user clicks New to create a new element for this shape it would inherit all 3 physical objects.

Removing a Physical Object Mapping

Similar to what happens when a user wants to add physical objects to a shape the user will also get feedback when they want to remove physical objects from a shape that already has elements assigned.

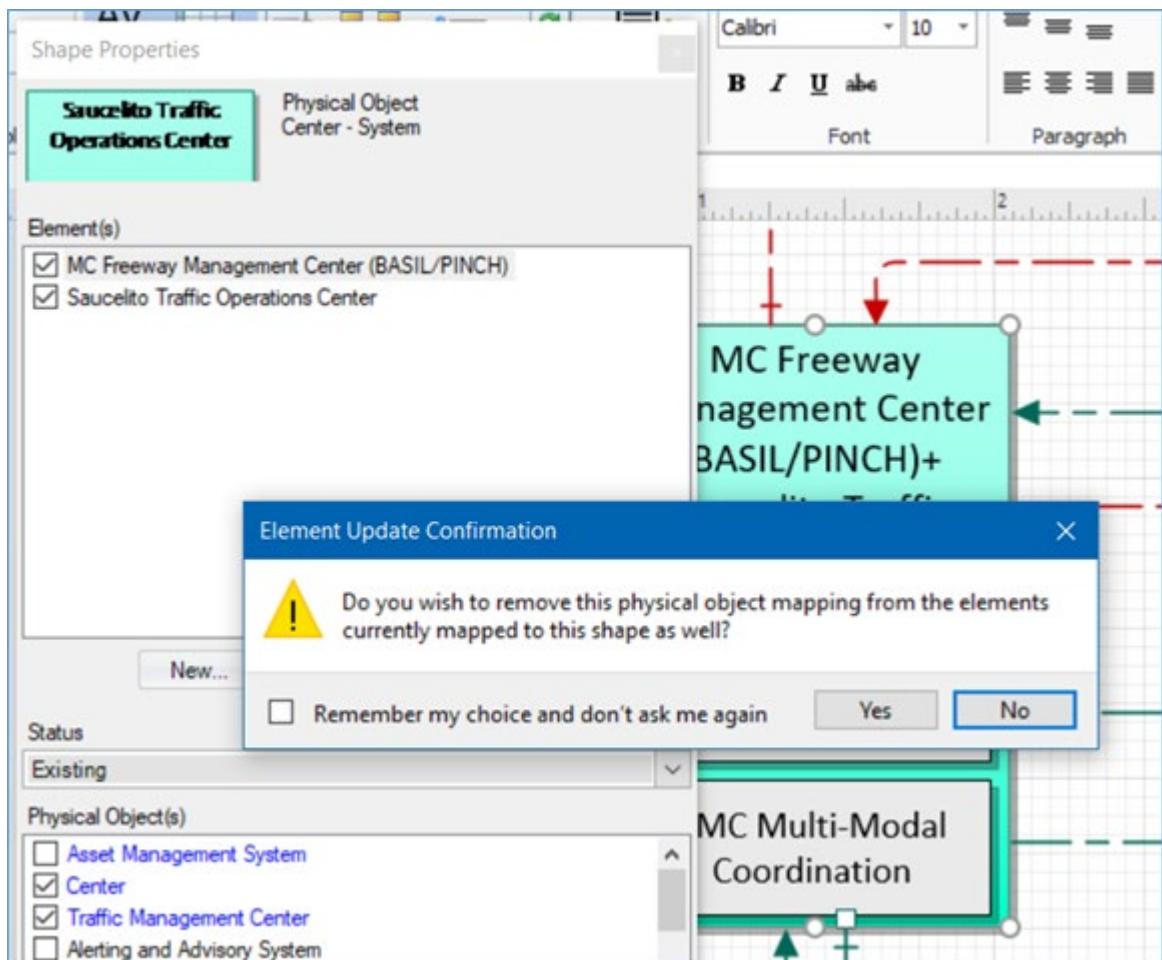

As seen above, the Element Update Confirmation screen is shown when a user has decided to uncheck a physical object from Shape Properties. It is asking if the user wishes to “remove this physical object mapping from the elements currently assigned to this shape as well.” Again, with the choices of Yes or No with an option to remember that choice. As we the adding of physical objects, if the user says No then the mapping change will only apply to the shape. The elements listed will

retain their physical object mappings as before. If the user says Yes then the elements will no longer be mapped to that physical object.

Another aspect of this removal of physical objects is in situations where a user might try to remove a physical object of a shape that had functional objects and flows that were only valid for that physical object. They will be warned with the following screen.

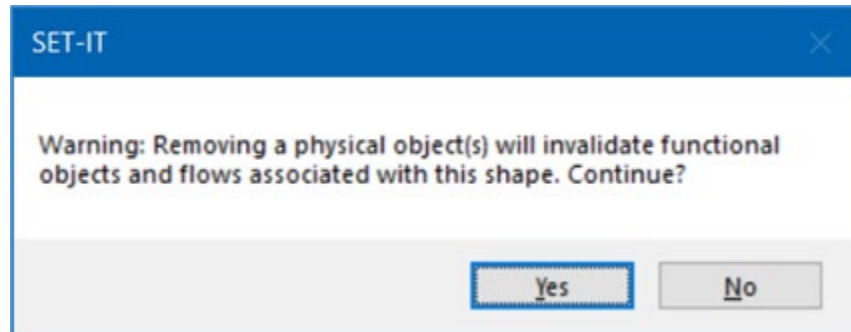

NOTE: Care should be taken any time changes are made to physical object mappings for shapes or elements, especially when a project has more than one diagram with those elements. That's why the dialog confirmation boxes appear.

How Do I Customize an ITS Class Shape?

Some service packages contain shapes that are from that 6th ITS Class of Physical Objects, e.g., SU05: Location and Time.

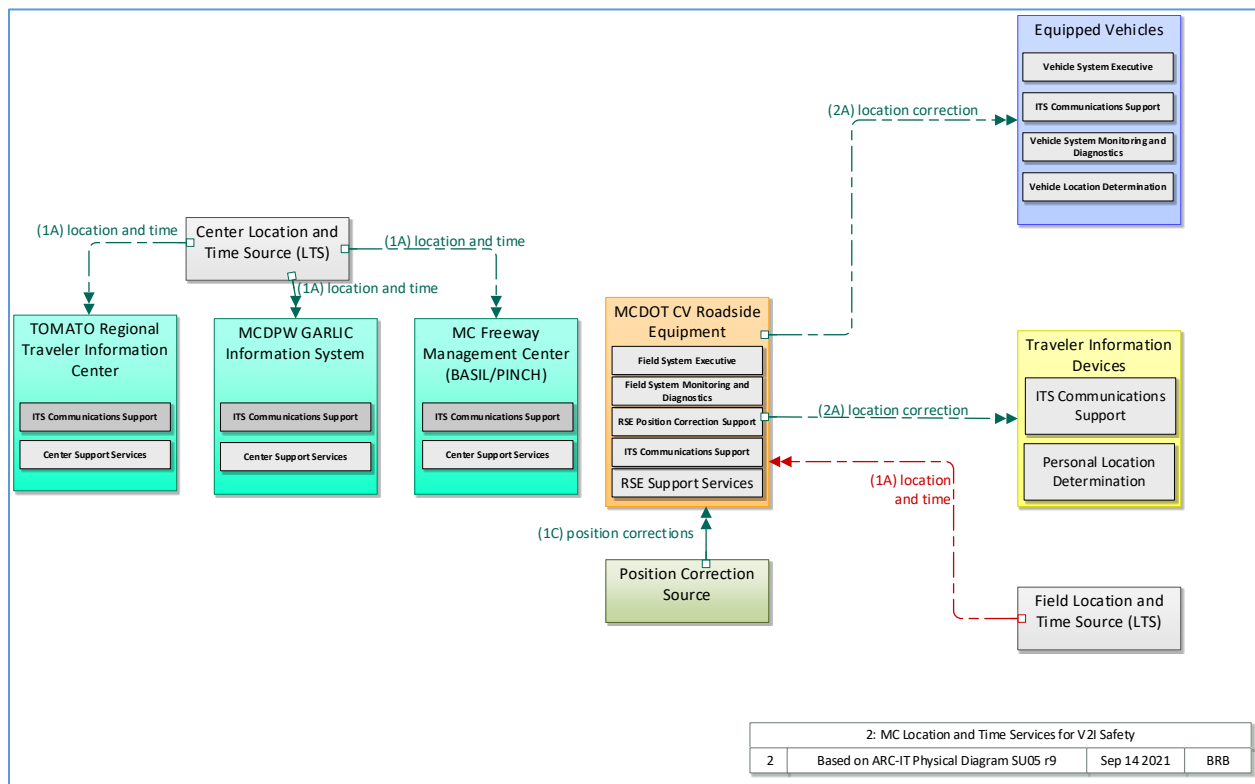

If you want to create elements for the grey ITS class shapes such as the Location and Time Data Sources, there are a few other steps you need to do.

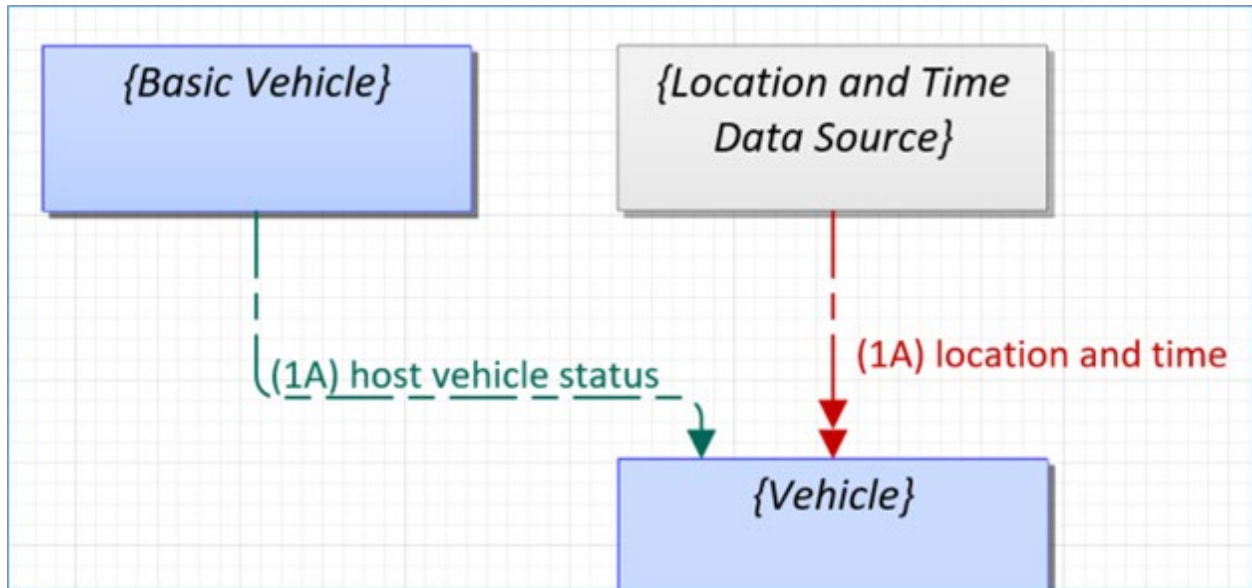

Click the grey {Location and Time Data Source} box, bring up Shape Properties and click New... This will bring up the Element Details form. Here you can give the new element a name, use the Class pull-down to set the class of the object. Select the class that corresponds to the class of the object you are connecting to, i.e., use Vehicle class if this L&TDS is to be connected to a Vehicle element.

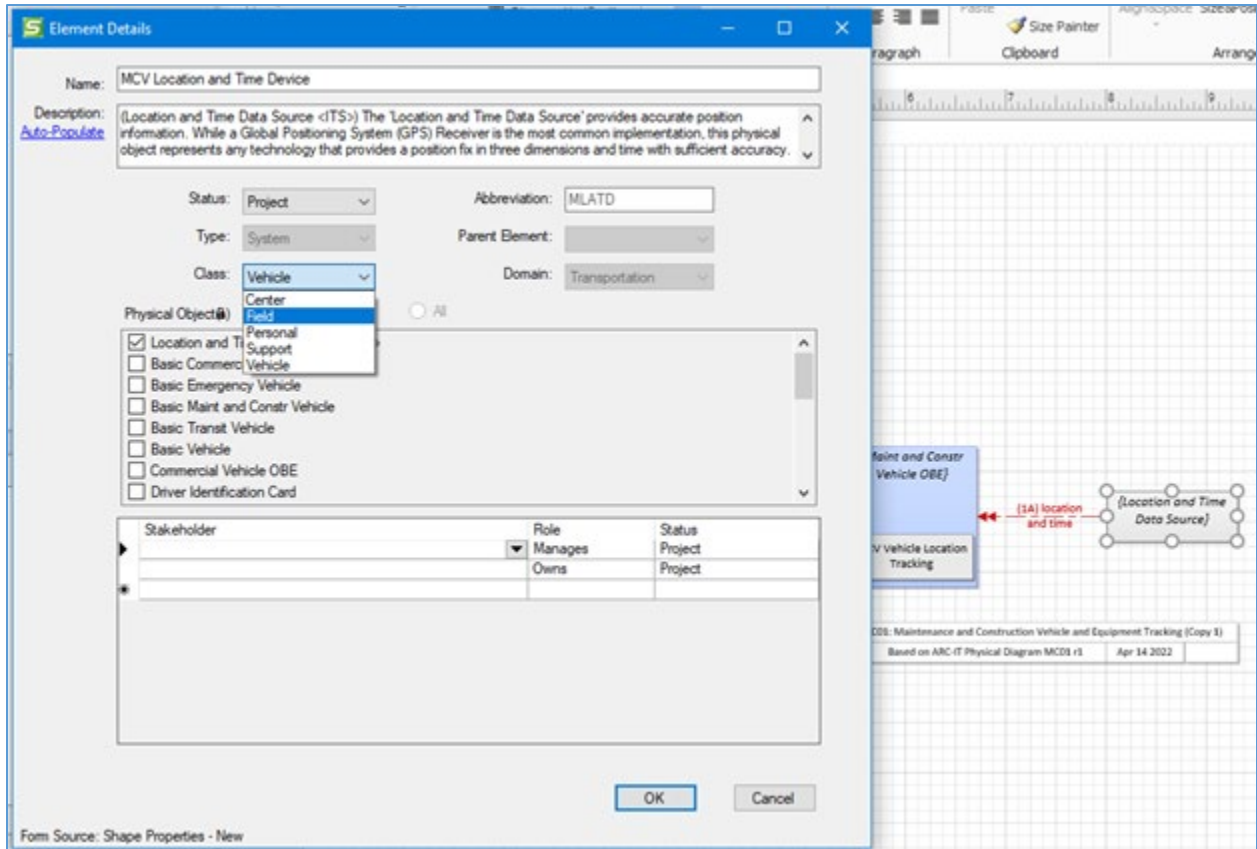

You can also use the New / Item menu and click Element to create a new element.

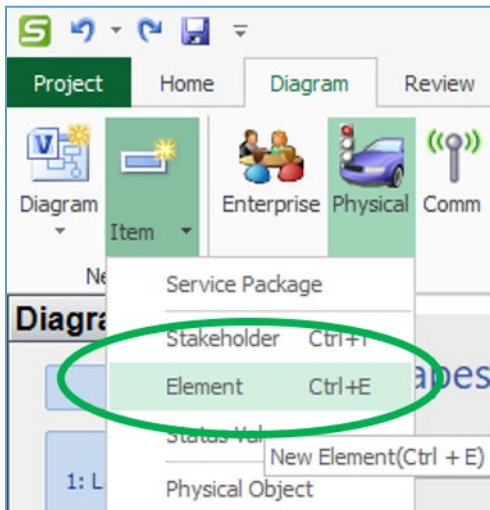

In Element Details change the class to the class you need and acknowledge the “are you sure” dialog box. Scroll through the list of Physical Objects and choose the Location and Time Data Source.

You can now click AutoPopulate to fill-in the description and assign stakeholders.

Element Details [Close] [Maximize] [Minimize]

Name: Document was last saved: Just now

Description: Auto-Populate

Status: Abbreviation:

Type: Parent Element:

Class: Domain:

Physical Object(s) Related All

- Light Vehicle OBE
- Location and Time Data Source <ITS>
- Maint and Constr Vehicle OBE
- Micromobility Vehicle OBE
- On-Board Weight Monitoring Equipment
- Other EV OBEs
- Other MCV OBEs
- Other Micromobility Vehicle OBEs

Stakeholder	Role	Status
<input type="text" value="Area Drivers"/>	Manages	Project
<input type="text" value="Area Drivers"/>	Owns	Project
* <input type="text" value=""/>		

Form Source: New Element

Click OK to add this Element to your inventory of elements for your project.

Now, back on the diagram you can double-click Shape Properties to select your new element to be matched with this shape.

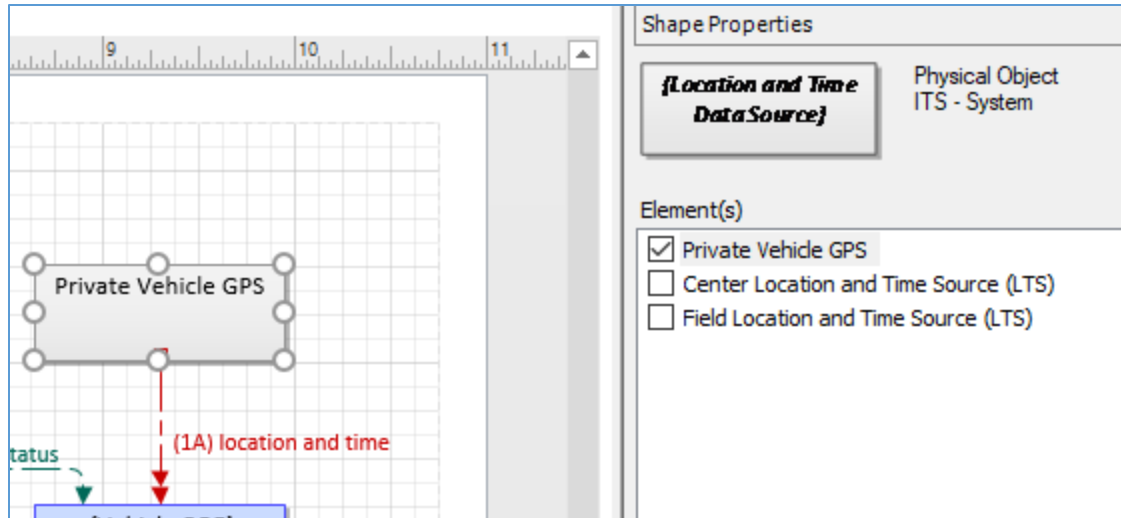

Shape Properties for Elements with Multiple Physical Objects

A note about the mapping of Elements to Physical Objects. As has been stated, an element can be assigned to more than one physical object. Think of this as having one device doing multiple jobs or one center being used to house more than one activity.

When ARC-IT was defined, the physical objects were defined to show where the interfaces might be in order to see what standards may need to be developed if information was to pass over an interface between different systems.

It was realized that some implementations would combine functionality in ways that ARC-IT may not have conceived. In some cases, functionality from one Physical Object may be distributed across multiple elements, e.g., 2 traffic management centers – one for freeway surveillance and another for traffic signal control. On the other hand, one element may be combining functions from more than one Physical Object, e.g., an integrated operations center that pulls together traffic management and emergency call dispatching into one system.

- SET-IT diagrams are based on ARC-IT service packages, formerly CVRIA applications. As such, they show the Physical Objects that are supporting that service package. In some cases, you may have an element that is doing those functions but may be mapped to other physical objects that support other service packages (on other drawings).
- SET-IT shows that in Shape Properties for an element as shown below:

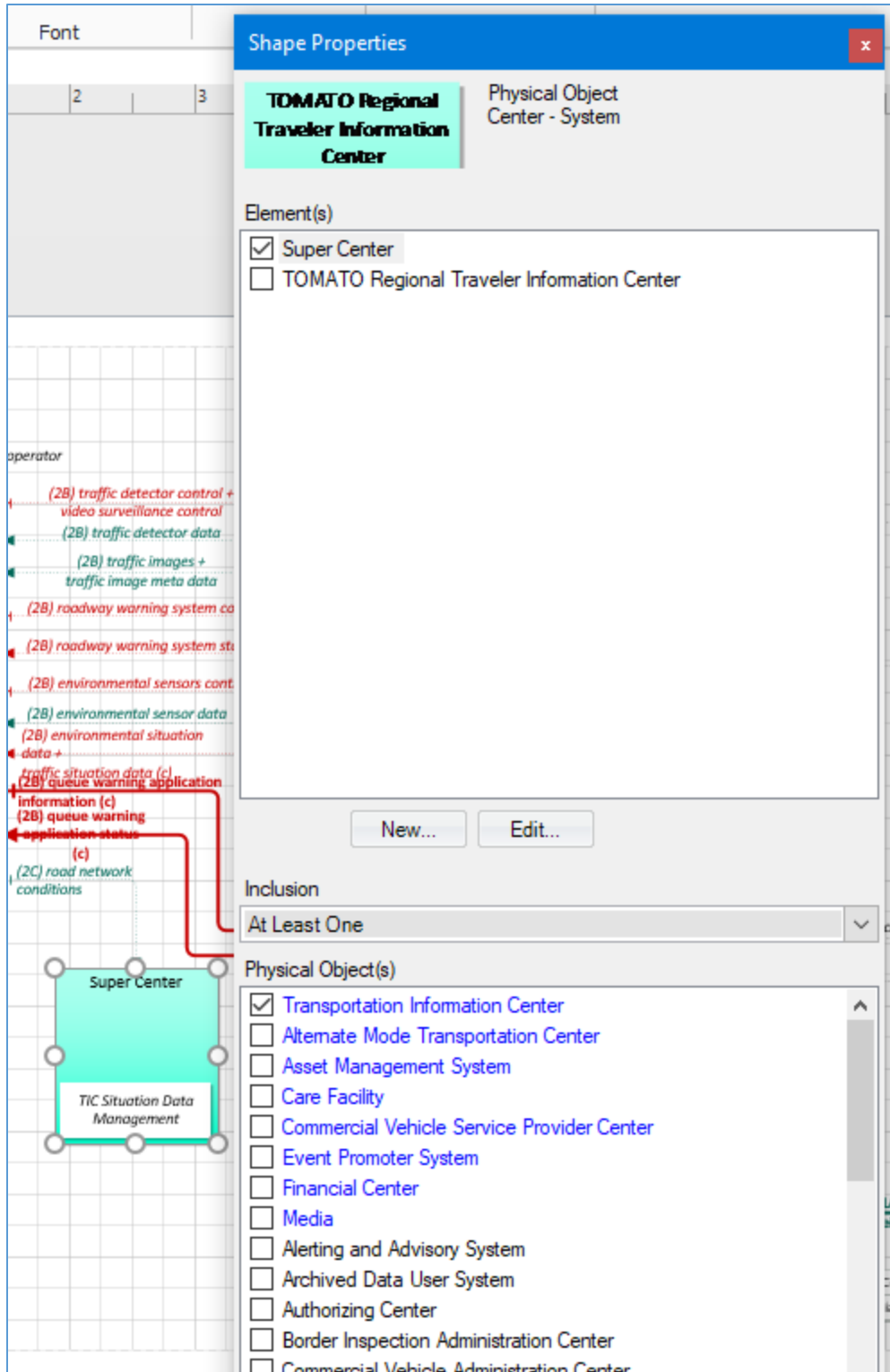

In this example, the “Super Center” element is mapped to many different ARC-IT physical objects but the diagram is only showing a Transportation Information Center (TIC). So, Shape Properties for this case shows the assignments of the Super Center to the TIC by using the color blue and checking the box. Shown in blue, but with no check marks are other Physical Objects to which it is mapped in the

definitions grid or on other diagrams. Move your mouse and hold the cursor over the physical objects and the 'hover-help' text will show what is meant by the coloring and checking.

The Elements grid in the Physical View Definitions menu will show the complete mapping of the Element to Physical Objects.

Create a New Information Flow

Creating a new information flow or what SET-IT calls a "User-Defined Flow" can be done from the diagram or from the Definitions menu.

To create a new flow from the diagrams, start by creating a New Diagram or opening an Existing Diagram.

Select the **Info Flow** from the stencil on the left and drag it to the diagram area.

Connect the selected **Flow** to appropriate **Physical Objects/Elements** in the diagram.

TIP: You will need to have associated Elements (local/customized things) with the ARC-IT Physical Objects in order for the next step to work. The assignment of flow names to lines on the diagram is done at the "element triple" level – that is, source element, destination element, and information flow. You may need to go back and edit the Shape Properties for the boxes to make sure they all have local/customized Element names.

Disappearing Corners? Sometimes an information flow seems to lose its cornering ability. It goes from a right-angle connector (the default) to a straight-line connector or seems to go off at a 45-degree angle. If this happens, you can add corners if they are lost by dragging the line mid-points and endpoints to get the corners in the desired spots.

If the information flow you want already exists in the project database use the steps in the next section to select the line, select one of the flows already defined for that source and destination combination, and assign the properties or characteristics for that flow.

If the flow you want doesn't exist yet – perhaps something unique to your project or situation – then click on the New... button on the Shape Properties to create the flow. See [Create a User Defined Flow](#) below.

NOTE: You cannot add an information flow that would go INTO an environmental terminator. Environment objects are there to represent the "things the sensors sense" and the flows from it are meant to be a one-way representation of the type of information being sensed by the field or vehicle-based sensors.

Flow Status

The deployment status of an information flow should be consistent with the elements on each end. As you connect a flow to go from one element to another SET-IT will assign the 'furthest out' status.

For example, if the source is existing and the destination is 'project' then the flow must also be 'project'. SET-IT also provides an automation feature such that if you change the status of one of the elements to be something 'further out' in time then you will see that the status of the flow will be changed to match that new 'further out' status. The automation does not work the other way – if you pull the status of the element furthest out back to something previous the status of the flow will stay the same.

Identify Shape Properties of Flows

From the diagram, double click on the **Flow** and the **Shape properties** form appears. The Shape Properties form is available in several places, including when viewing flows on diagrams. This form will be used to identify Name, Status, and communications characteristics of flows.

Shown here are 2 examples. The diagram on the left is for a system flow routed through a Communications system with an alias applied. The diagram on the right is for a human interface flow routed through a secure remote access device.

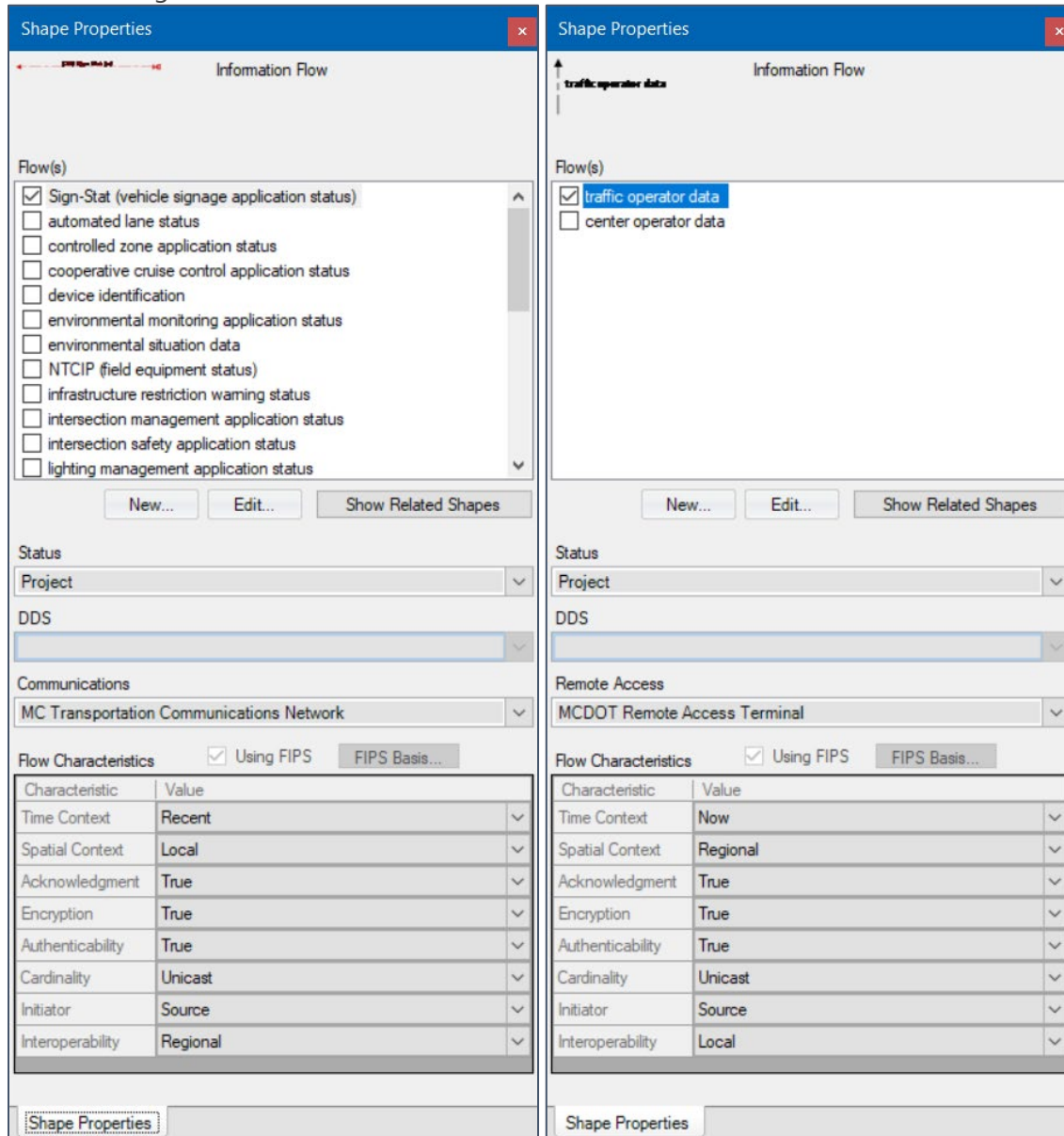

Flow(s): Depends on the source and destination of the **Flow**, a list of appropriate Flow names appears on the box at the top of the form. Whenever a flow Alias is applied that alternative name will be shown in Shape Properties with the original name of the flow listed in parentheses.

Click on the appropriate **Flow** name from the list and the selected **Flow** name will appear on the line.

Click the New... button to create a new information flow for this line between elements. This will launch the Flow Details screen. From Shape Properties click this button will pre-populate certain

characteristics since it is coming from a selected flow on a diagram, including the source and destination elements and default flow characteristics.

Click the Edit... button on Shape Properties for a highlighted flow to also open Flow Details. This will let you edit some of the characteristics and descriptions, but some fields will be read-only since it preserves what is on the diagram. Change the diagram first then edit the values in Flow Details.

Click "Show Related Shapes" and it will highlight the flows that are related to that selected flow or functional object – requests that go with responses, status flows that go with configuration flows, etc. This can be really useful on complicated diagrams. If a flow or functional object doesn't have any defined relationships between it other flows, then this button will just be greyed out.

Flow Status: Select appropriate **Status** from the pull-down menu on the middle of the form. Status has to do with the timeline of deployment – whether this interface already exists (*existing*), is part of the project you are architecting (*project*), or might be a new concept that a (*future*) project might want to consider but you want to go ahead and let your readers start to see it.

Select **Status** from the pull-down menu, and the line style of the line changes appropriately for different Status values. For lines that have multiple flows SET-IT will use the lowest value, typically the nearer term value depending on how your Status Values have been defined in the Definitions menu.

DDS: If this flow will go through a data distribution system use the pull-down to select the Element that will act as the data distribution system for this information. On the diagram the flow name will have a "**(d)**" appended to the name to indicate that it goes through a data distribution system. You will need to create an element mapped to a Support class Data Distribution System physical object first in order for it to be visible. You can click New Element... and it will bring up a blank Element Details for form you to create a new DDS.

Communications: If this flow will go through a communications domain element (e.g., Wide Area Dissemination) use the pull-down to select the Element that will act as the communications system for this information. On the diagram the flow name will have a "**(c)**" appended to the name to indicate that it goes through a communications system. You will need to create an element mapped to a Support class Communications domain physical object first in order for it to be visible. You can click New Element... and it will bring up a blank Element Details form for you to create a new Communications element.

Remote Access: If this flow is a human interface flow between a Center or Support element and a Human operator/user then it can be assigned to go through a Remote Access Device. As you click a human interface flow the Communication pull-down will change to say Remote Access. Use the pull-down to select the Element that will act as the remote access device for this information. Click the "New Element..." choice if you need to create an element. On the diagram the flow name will have an "**(r)**" appended to the name to indicate that it makes use of a remote access device.

NOTE: According to ARC-IT, not every information flow is eligible for routing through a data distribution system or communications system. Flows to/from environmental terminators are not possible so the pull-down will be greyed out. Other flows might be appropriate for information

broadcast from a single source to many destinations at once and might use a Wide Area Information Distribution mechanism but not something like a data warehouse or clearinghouse. In those situations, the *Communications* pull-down will be activated to show the Wide Area Dissemination elements but the DDS pull-down will still be greyed out. Human interface flows will cause the Communications pull-down to change to say Remote Access.

NOTE: The *c*, *d*, or *r* symbol will be displayed to the right of the last flow name on a line. Even if there are multiple information flows on the same line but only one of them is going through a communications, data distribution, or remote access element. Printing the information flow triples as a report will show the details. Depending on how complicated your diagrams already are you may consider splitting the flows up into multiple lines to better indicate which are and are not using a communications or DDS element.

NOTE: This may seem obvious but you cannot route a flow through itself which means if you see a flow going to a Data Distribution System (DDS) then you will not be able to use the DDS pull-down and select that system for it to go through.

When you disconnect a line on a diagram all the characteristics for that line will disappear and the line color will revert back to black to indicate that it has not characteristics. Connect it back to an element shape and recheck whether it is to be routed through a Comm or DDS and the line styles and characteristics will be restored.

See the section on [Using Data Distribution](#) in the [Other Diagram Tools](#) for further discussion on Data Distribution. Yes, you can connect flows directly to the DDS or communications elements if they are 'dds-' or 'comm-eligible', meaning they are defined in ARC-IT as flows that could be directed through a data distribution system or a wide area information disseminator.

Flow Characteristics: **Flow Characteristics** attributes on the bottom of the **Shape Properties** Form identifies the communication characteristics of the flow.

Using FIPS: The "Using FIPS" check box indicates whether the methodology from the FIPS 199 to characterize the flow in terms of its requirements for Confidentiality, Integrity, and Availability. Check this box and click **FIPS Basis...** to document the settings and rationale with this approach. See [Using FIPS](#) below. NOTE: this method is in lieu of using the Encryption and Authenticability values directly in Shape Properties. *Using FIPS doesn't make sense for every flow – the human interfaces, for instance, will not have FIPS analysis.*

Flow Characteristics

Select the appropriate **Flow Characteristics** values from the pull-down menu on the bottom of Shape Properties. By modifying these attributes, different communication symbols appear on the line to indicate their spatial context requirements or their timing requirements and the color of the line changes appropriately.

Flow characteristics are set to allow the right communications solution to be assigned when you go to the Communications View. If you make a change to the characteristics defined by ARC-IT it will

ask if you want to create a user defined copy of the flow. This will preserve your customizations and let you use SET-IT's Comm View to choose the right solutions.

The *Time* context requirements are expressed as a number:

- 1> **Now** (something needed in near real-time such as an intersection movement indicator from another vehicle)
- 2> **Recent** (something used to understand the current situation such as traffic flow data at an intersection)
- 3> **Historical** (something that has already happened such as a set of transit ridership numbers for an archive)
- 4> **Static** (something that doesn't change or doesn't change very often such as the text of a roadside sign)

The time context is then followed by a letter indicating the flow's *Spatial* context:

- A> **Adjacent** (something very close to where it is needed such as data within the onboard systems of a vehicle)
- B> **Local** (something to be used in close proximity of where the data was created such as an intersection controller)
- C> **Regional** (something used by the surrounding region such as traffic flow data along a freeway corridor)
- D> **National** (something used by the entire country such as a nationwide emergency message)
- E> **Continental** (something used wherever connected vehicles may be such as an application update)

These time and spatial characteristics can be hidden from the diagrams if you want to declutter how they are presented. Use the Diagrams tab of the Options window to change these settings. They will take affect on your diagrams as soon as you close the Options window. See the [SET-IT Options / Diagrams](#) section.

At Layer 2, the information flows can also have the following characteristics:

- Acknowledgement – True / False
- Encryption – True / False
- Authenticability – True / False (if FIPS is used this will be locked)
- Cardinality – Unicast / Broadcast / Multicast (if FIPS is used this will be locked)
- Initiator – Destination / Source / None (blank)
- Interoperability – National / Regional / Local / None / Not Applicable
- Latency – High/Medium/Low/Ultralow (set on the Flow Details form)

TIP: Include a Legend on at least one of your diagrams. This will help you and your readers see what the different symbols and color-coding mean. The physical and enterprise drawing stencils include either a vertically oriented legend or a horizontal legend depending on where you have the most real estate on your drawing.

NOTE: Lines that contain multiple flows may have different characteristics for different flows. Look to see which flow is selected/highlighted at the top area of the Shape Properties box. For example, if a flow contains both an encrypted flow and an open or unsecured flow, then the line

will show the characteristics of the most stringent setting. That is to say, it will be red as if all the flows on that line were encrypted.

In the example below, a line with 2 flows is used. On the left the first flow is selected and, on the right, the second flow is selected.

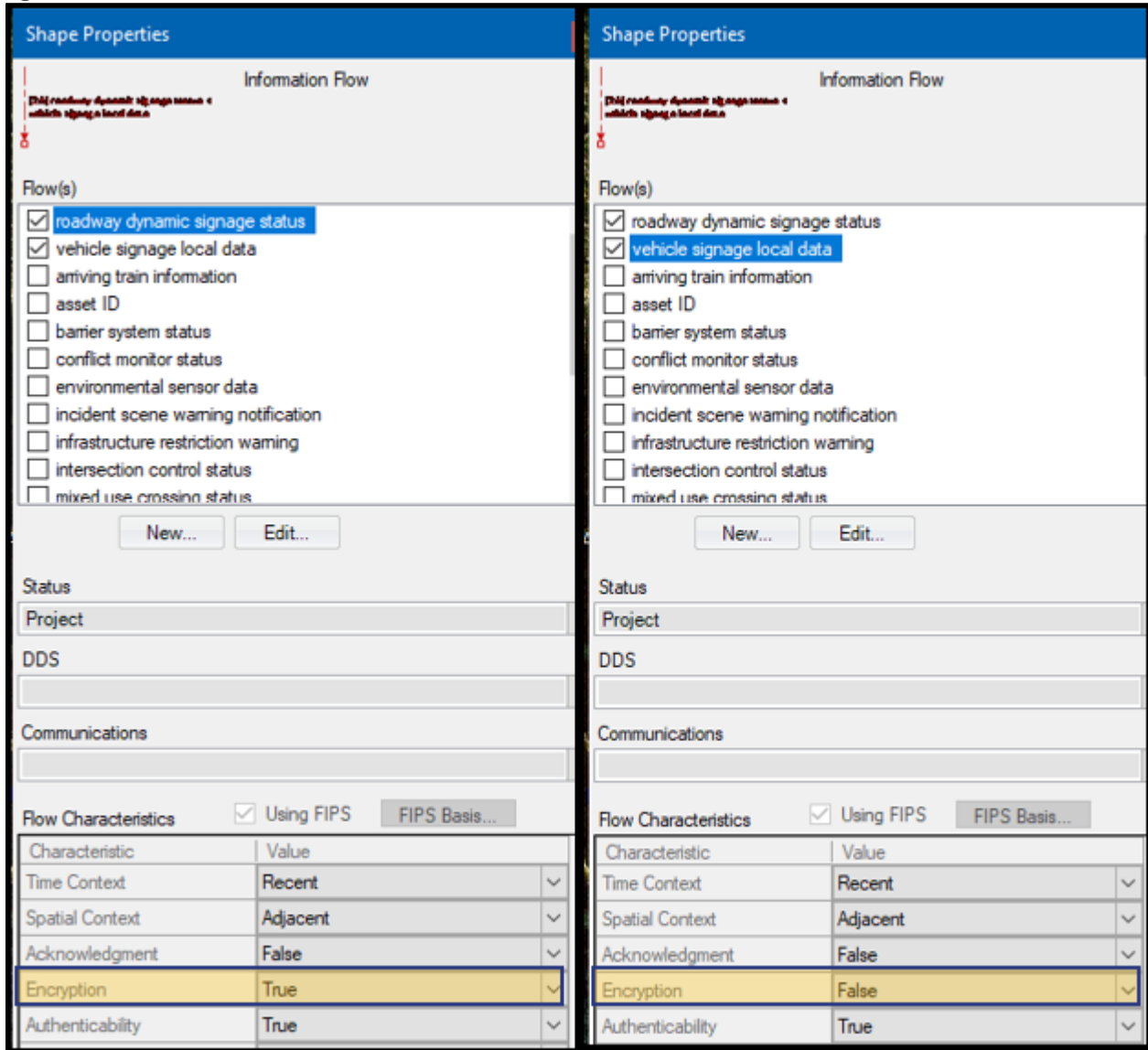

The encryption values are different for each flow. The line style uses the most-restrictive security setting, encrypted=true in this case. There could be other characteristics that are individually relevant to a flow such as the eligibility to use Data Distribution or Communications. When in doubt, click each of the flows to see what is going on. You can always split the lines to show the flows individually but this may not be feasible or desirable on a complex drawing.

As you go higher in the project architecture hierarchy different characteristics will apply because the interconnects are collections of flows and not all flows will have all of the same exact characteristics.

At Layer 1 and 0, the physical interconnects can have the following characteristics:

- Encryption – True / False (if FIPS is used this will be locked)
- Authenticability – True / False (if FIPS is used this will be locked)
- Cardinality – Unicast / Broadcast / Multicast

Click **New...** or **Edit...** from the Shape Properties window to open up the **Information Flow Details** form/window. From here you can also make changes to the flow's characteristics and descriptions.

The screenshot shows the 'Information Flow Details' window with the following configuration:

- Name:** environmental sensor data
- Alias:** NTCIP-ess
- Description:** Current road conditions (e.g., surface temperature, subsurface temperature, moisture, icing, treatment status) and surface weather conditions (e.g., air temperature, wind speed, precipitation, visibility) as measured and reported by fixed and/or mobile environmental sensors. Operational status of the sensors is also included.
- Type:** System
- Encryption:** False
- Authenticability:** True
- Cardinality:** Unicast
- Using FIPS:**
- Latency:** Low
- Time Context:** Recent
- Spatial Context:** Local
- Initiator:** Destination
- Acknowledgment:** False
- Interoperability:** Regional
- FIPS Section:**
 - Confidentiality:** Low
 - Confidentiality Basis:** Little to no impact if this data is observed
 - Integrity:** Moderate
 - Integrity Basis:** info should be correct to determine safe speeds etc.. DISC: WYO believes this to be HIGH
 - Availability:** Moderate
 - Availability Basis:** Updates are desirable but slightly outdated information will not be catastrophic.
- Table:**

Source Element	Source Physical Object	Destination Element	Destination Physical Object	Status	DDS	WAIDS	RCU
MCDOT Environmental Sensor	ITS Roadway Equipment	MC Freeway Management Center (BASIL/PINCH)	Traffic Management Center	Future	<input checked="" type="checkbox"/>	<input type="checkbox"/>	<input type="checkbox"/>
- Source Functional Objects:**
 - Roadway Environmental Monitoring
- Destination Functional Objects:**
 - TMC Environmental Monitoring
 - TMC Basic Surveillance
 - TMC In-Vehicle Signing Management
 - TMC Roadway Warning
 - TMC Speed Warning

Type indicates whether an information flow is between Systems, Humans, and a System, or from an Environmental terminator.

You can view the Functional Object assignments provided by ARC-IT and add additional Functional Object assignments. From here you cannot remove assignments provided by ARC-IT. Note the Blue text used to indicate Read-Only.

If you make changes to the characteristics of an information flow that came from ARC-IT, then SET-IT will automatically-create a user defined triple in the underlying database table of Physical Object Flows. Now you can make changes to your flow that are unique to your project's needs without changing the ARC-IT flow's definitions.

Using FIPS

The "Using FIPS" check box on Shape Properties indicates whether the methodology from FIPS 199 was used to characterize the flow in terms of its requirements for Confidentiality, Integrity, and

SET-IT Help

Availability. Check this box and click "FIPS Basis..." to document the settings and rationale with this approach.

Click the "FIPS Basis" button from Shape Properties or Click the FIPS button on the menu bar for the Physical Diagram.

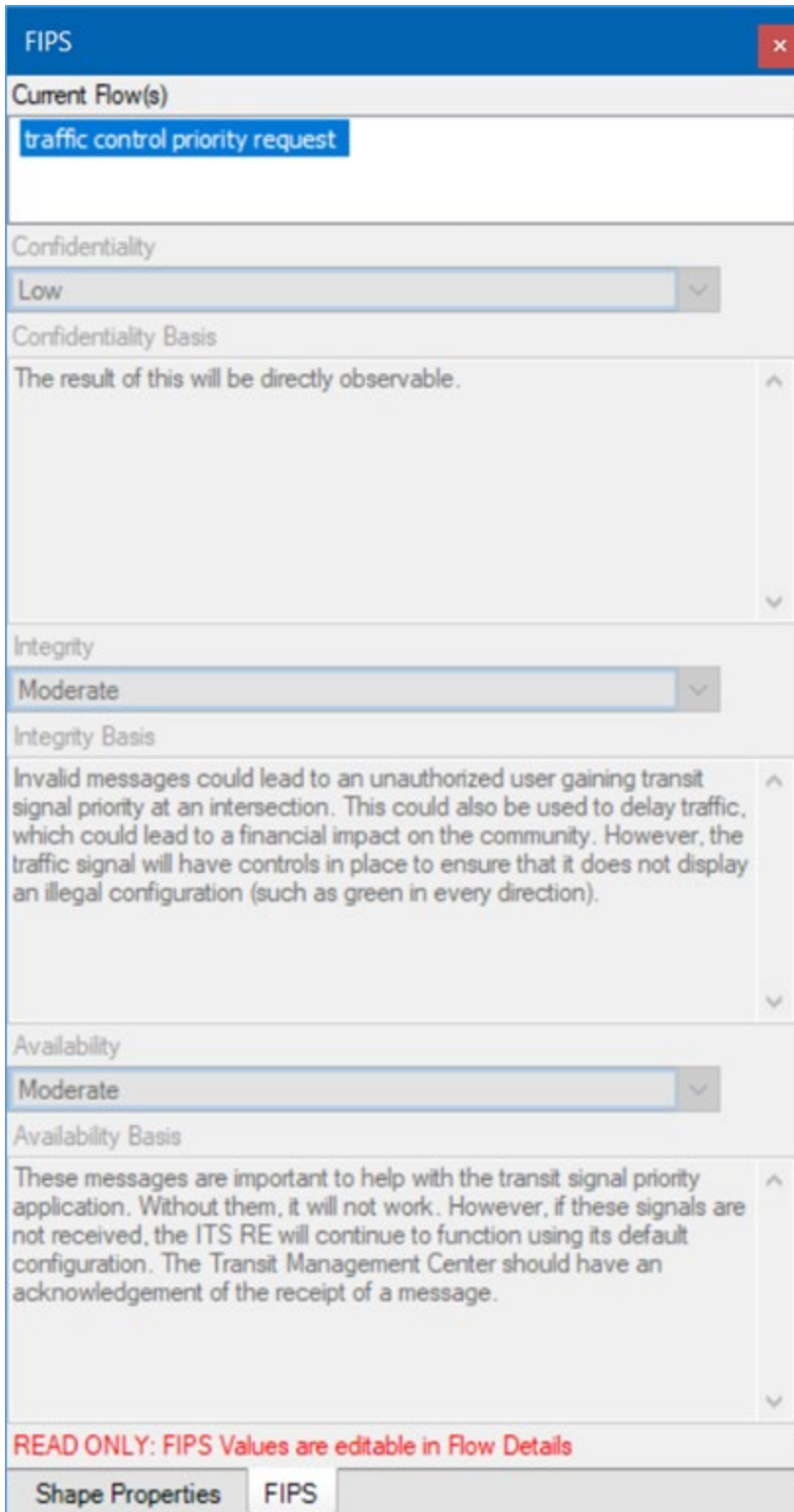

NOTE: Shape Properties must also be active (open) in order for the FIPS Basis window to be populated. Even if you click the FIPS button from the menubar it will only populate if Shape Properties is also opened.

NOTE: Also, this FIPS basis screen is read-only from Shape Properties. As the note says at the bottom of the screen, these values are editable from Flow Details. Go back to the normal Shape Properties window, select a flow, and click Edit.

Definitions from the Federal Information Security Management Act (FISMA) of 2002 and FIPS Publication 199:

Confidentiality: Preserving authorized restrictions on information access and disclosure, including means for protecting personal privacy and proprietary information. A loss of confidentiality is the unauthorized disclosure of information.

Valid Values: Not Applicable, Low, Moderate, High

Integrity: Guarding against improper information modification or destruction, and includes ensuring information non-repudiation and authenticity. A loss of integrity is the unauthorized modification or destruction of information.

Valid Values: Low, Moderate, High

Availability: Ensuring timely and reliable access to and use of information. A loss of availability is the disruption of access to or use of information or an information system.

Valid Values: Low, Moderate, High

The Confidentiality and Integrity of a flow affects whether or not Encryption should be used and whether or not the sender of the flow should be Authenticated. Here is the formula:

- If Confidentiality > Low, Encryption = True;
- Else If Confidentiality <= Low, Encryption = False
- If Integrity > Low, Authenticability = True;
- Else If Integrity <= Low, Authenticability = False

NOTE: Using FIPS is in lieu of using the Encryption and Authenticability values in Shape Properties. If there are values set on the FIPS Basis screen, then the Encryption and Authenticability values on the Shape Properties menu will be set based on the formula above and the pull-down will be locked.

NOTE: When you click on a flow line on a diagram that has more than one flow name on the same line and bring up the FIPS Basis window you will see the list of flows at the top area of the FIPS Basis window. As you click each flow at the top you will see the C-I-A values and rationale in the bottom. SET-IT calculates the coloring of the flows on the diagram based on the most stringent setting of the multiple flows. For example, if one flow has Low confidentiality but another has Medium Confidentiality then the flow will be colored based on the Medium setting (Blue or Red depending on the Integrity setting).

TIP: If you want to change FIPS information for individual triples, add another line to the drawing, assign the flow you want to change to that line and change the FIPS settings from there.

NOTE: For Human Interface flows, regardless of what settings there are for the C-I-A values on the Using FIPS screen the flows will still appear as black for no Encryption or Authenticability since there is no way to encrypt or describe how to encrypt a machine-to-human flow or to practically authenticate the information on such an interface.

Changing FIPS values (and other characteristics) may trigger the need for a new or different Communications solution so if you make changes to any of the FIPS values you may see a pop-up window asking if you want to make a user defined copy of the flow. Say yes and all of your information will be copied from that ARC-IT based flow to a new user defined flow that preserves your choices and allows you to continue customizing.

Create a New or User Defined Information Flow

Sometimes SET-IT may not have the information flow you need. The database that comes with SET-IT contains over 900 information flows based on the physical view from ARC-IT. But as ITS and connected vehicle technology keeps evolving new projects are bound to have interfaces that are new and unique. Creating a new or User Defined Flow in SET-IT is easy.

There are a couple of ways to create a new flow:

- From the New Items menu
- From Shape Properties on a Diagram

Creating a flow from the New Item Menu

At the top left of the screen click the Item pulldown from the New area and select the Information Flow. The Information Flow Details window opens.

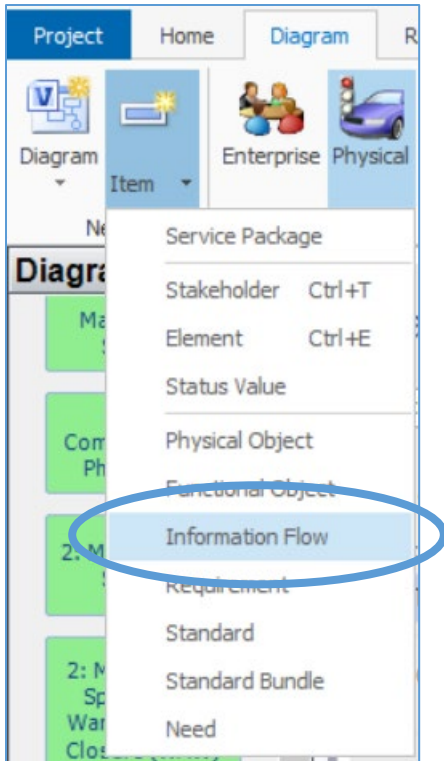

If you use the New menu Item to start the process you will be in what SET-IT calls "PObject Mode", meaning that the flow is being created completely from scratch and you have to select the source and destination physical objects before selecting the project's elements.

The image shows the 'Information Flow Details' dialog box. The 'Name' field is 'xtra snow plow data'. The 'Description' is 'This unique flow shows the center more details about what is going on with the snow plow.' The 'Type' is 'System'. The 'Encryption' is 'True', 'Authenticability' is 'True', and 'Cardinality' is 'Unicast'. The 'Latency' is 'Low', 'Time Context' is 'Recent', and 'Spatial Context' is 'Local'. The 'Initiator' is 'Source', 'Acknowledgment' is 'True', and 'Interoperability' is 'National'. The 'FIPS' section shows 'Confidentiality' as 'Moderate', 'Integrity' as 'Moderate', and 'Availability' as 'Moderate'. The 'Source Physical Object' is 'Maint and Constr Vehicle OBE' and the 'Destination Physical Object' is 'Maint and Constr Management Center'. The 'Status' is 'Project'. The 'Replaces' column has checkboxes for 'DDS', 'WAIDS', 'RCU', and 'ICE', all of which are checked. The 'Source Functional Objects' list includes 'MCM Winter Maintenance' (checked). The 'Destination Functional Objects' list includes 'MCM Winter Maintenance Management' (checked). The 'Form Source' is 'New Flow'. There are 'OK' and 'Cancel' buttons at the bottom right.

The Type pull-down lets you set this as a flow between Systems, between a Human operator and a System, or from an Environmental terminator.

The Alias box lets you define an alias for a flow and the Apply Alias checkbox lets you determine when you want that alias to be used on your diagrams and outputs. A flow alias is a way to use a customized name for an information flow while retaining the mappings to the ARC-IT reference model for that flow. For example, if you are doing a connected vehicle project to collect probe data from passing vehicles for traffic monitoring purposes you may want to just show the term "BSM" for the basic safety message defined in the SAE 2735 standard rather than the full name of the ARC-IT information flow, "vehicle location and motion for surveillance". It isn't common for a user defined flow to also have an alias.

In the PObject Mode for a new user defined information flow the pull-downs for Source and Destination are Physical Objects as shown above.

Once the PObjects are identified SET-IT will run some queries and determine which Functional Objects should be available to select as part of the interface. It will also populate the default settings for the flow characteristics including the security settings, cardinality, as well as time and spatial context. Even though you haven't selected "Using FIPS" yet for your new flow SET-IT will need a default value for Confidentiality and Availability in order to assign the new flow to an appropriate communications solution so you will see the values and the Basis fields populated even though they are greyed out.

The checkboxes that appear to the right of the source and destination show you the eligibility settings for use of Communications objects and the Data Distribution System (DDS) object. The abbreviations stand for:

- DDS: Data Distribution System
- WAIDS: Wide Area Information Dissemination System
- RCU: Roadside Communications Unit
- ICE: Intelligent Transportation System Communications Equipment
- RAD: Remote Access Device (for Human interfaces to Center or Support elements)

See the www.arc-it.net website for information about this physical objects.

As you select physical objects SET-IT will preselect values of eligibility based on the class of the source and destination. You can change this when you create or edit a user defined flow for your project.

NOTES about assigning characteristics. When a flow is created it needs to be characterized in a way that will allow the right communications solution to be assigned when you go to the Communications View. SET-IT will set default values for Confidentiality, Latency and Availability since the communications profile and solution assignment rules rely on those characteristics.

If the user does not make any assignments to these fields, SET-IT will set them as follows:

Confidentiality is related to Encryption. If Encryption is set to False then the initial Confidentiality value will be Low. If Encryption is set to True then the initial Confidentiality value will be Moderate.

The statement, 'Confidentiality value set to default by SET-IT.' will automatically be added to the ConfidentialityBasis field.

Availability is to the same value as Confidentiality and SET-IT will automatically add the statement, 'Availability value set to default by SET-IT.' to the Availability Basis field.

Latency from a general point of view is a time delay between the cause and the effect of some physical change in the system being observed, or a measure of the time interval between the input to a stimulation and the visual or auditory response. Applications requiring low or ultralow latency like a real-time system will required very different communications solutions than the posting of static (or rarely changing) display information. In SET-IT, Latency is set based on Time context as follows:

<u>Time Context</u>	<u>Initial Latency Value</u>
Now	Ultralow
Recent	Low
Historical	Medium
Static	Low

Interoperability refers to the ability of two or more systems or components to exchange information and to use the information that has been exchanged. The higher the level the greater the expectation is that the information will be defined and implemented consistently across all systems and applications at that level. The lower levels required interoperability mean there isn't as much concern that the flow be implemented consistently in different settings (projects, locations, applications). In SET-IT and the ARC-IT reference architecture upon which SET-IT is based, Interoperability is assigned to information flow triples (source, destination, flow name) and can have the following values:

<u>Interoperability Level</u>	<u>Description</u>
National	This triple should be implemented consistently within the geopolitical region through which movement is essentially free (e.g., the United States, the European Union).
Regional	Interoperability throughout the geopolitical region is highly desirable, but if implemented differently in different transportation management jurisdictions, significant benefits will still accrue in each jurisdiction. Regardless, this Information Flow Triple should be implemented consistently within a transportation jurisdiction (i.e., the scope of a regional architecture).

<u>Interoperability Level</u>	<u>Description</u>
Local	In cases where an interface is normally encapsulated by a single stakeholder, interoperability is still desirable, but the motive is vendor independence and the efficiencies and choices that an open standards-based interface provides.
None	Information Flow Triple interoperability between jurisdictions and between different instances in the same region would have no benefit, either regarding efficiency or functionality.
Not Applicable	Interoperability ratings don't apply per se to some types of interfaces like human interfaces. These interfaces may still benefit from associated standards (e.g., ergonomic and human factors standards for human interfaces), but the primary motive for these standards is not interoperability.

The other thing you can do at this point with a New or User Defined Information flow is define this new flow as a replacement for an existing ARC-IT information flow.

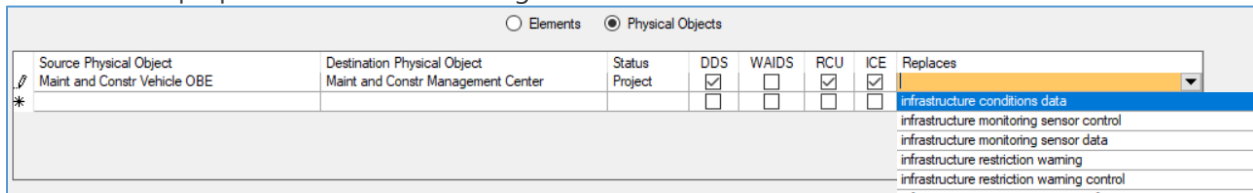

Identifying a New User Defined Information Flow as a replacement for an ARC-IT flow is a good idea if you want to show things are a certain way in your region. Beware that it may also make sense to retain the linkage both in name and underlying data between your architecture and the ARC-IT reference to assist with interoperability with other projects and agencies that may not know what your names mean.

Once you have finished filling in the characteristics for your new flow you can now select this on your diagrams whenever you have shapes that match the source and destination PObjects selected.

Flows to or from an Environmental terminator have very few characteristics that can be set by the user so many of the fields on Flow Details will be grayed out.

Creating a Flow from the Diagram's Shape Properties

Start with a diagram that is already customized, i.e., elements are created/selected for all the physical object shapes. From the Shape Properties window shown in the previous section, click the New... button. The Information Flow Details window opens.

This is accessed from the Diagrams via the Shape Properties window by clicking dragging a flow between 2 elements (physical object boxes that have been customized with local, project-specific names) and clicking "New..." This is what SET-IT calls "Elements Mode" for new information flows.

Information Flow Details

Name: User Defined

Alias: Apply Alias

Description:

Type: [Hyperlink](#)

Encryption: Using FIPS Latency: Initiator:

Authenticability: Time Context: Acknowledgment:

Cardinality: Spatial Context: Interoperability:

FIPS

Confidentiality: Integrity: Availability:

Confidentiality Basis: Integrity Basis: Availability Basis:

Source Element	Source Physical Object	Destination Element	Destination Physical Object	Status	DDS	WAIDS	RCU	ICE	Replaces
MCDOT Maint Vehicles	Maint and Constr Vehicle OBE	MCDPW GARLIC Information System	and Constr Management Center	Project	<input checked="" type="checkbox"/>	<input type="checkbox"/>	<input checked="" type="checkbox"/>	<input checked="" type="checkbox"/>	
			Center						
			ITS Object						
			Maint and Constr Management Center						

Source Functional Objects:

MCV Roadway Maintenance and Construction

Destination Functional Objects:

MCM Field Equipment Maintenance
 MCM Maintenance Decision Support
 MCM Roadway Maintenance

Form Source: Shape Properties - New

Note that in Elements mode – the Information Flow Details screen is different. Here, instead of seeing just the Physical Objects we see the Elements first. If an element is mapped to more than one physical object you will need to use the Source or Destination Physical Object pull-down to tell SET-IT which of the physical objects to which this element is assigned you want this flow to apply to. You can add 'triple' combinations by using the new row for this mini table. The Functional Objects portion of the form only shows a few functional objects. The Element mode of the form is inheriting information from the Diagram and you are not allowed to make as many changes since it could corrupt some of the mappings between the shape on the diagram and the physical object assignments in the database.

In either Elements or PObjects mode, the Flow Details window contains an area to enter the Name of the information flow, an optional alias, a brief description, and then areas to determine the source, destination, and the other characteristics described on the Shape Properties window.

If you access this Information Flow Details from the diagrams and you already had the line connected to 2 customized objects (elements) on the diagram, then the source and destination elements will be pre-populated. If the flow was drawn between 2 boxes that hadn't been customized with elements on both sides yet, the source and destination area will be filled with the physical objects corresponding to the objects on the diagram.

You can also select the Functional Objects, the smaller units of functionality within the Physical Objects, affiliated with this new flow. As you select the Physical Objects for source and destination the Functional Objects choices will be narrowed down to the appropriate functional objects from the Architecture for the service package selected.

Also, if all you did was select the source and destination and say OK, SET-IT will pre-populate the flow characteristics with a predefined set of defaults. You can change them, but this will give you a starting point.

Sometimes, your element may be mapped to more than one physical object. When this occurs SET-IT will not be able to automatically determine which pair of physical objects to associate with the flow. So, if you were in Elements view SET-IT will prompt you to enter the appropriate Physical Objects in order for it to determine the precise mapping for this new flow.

NOTE: If you delete a row in the Source / Destination physical objects or elements portion of the Flow Details screen you may get different results. If deleting one row will effectively negate the other rows – say, they are all mapped to the same combination of physical object sources and destinations then you will see a Warning pop up asking you to verify that you want all the combinations to be deleted.

NOTE: If the "Using FIPS" checkbox is checked on the Shape Properties window the Encryption and Authenticability settings will be greyed out. Use the FIPS Basis screen to change the Confidentiality, Integrity, and Availability requirements that will then affect the Encryption and Authenticability values.

Functional Objects on a Diagram

Functional Objects are subsets of a physical object and are used to define more specifically the functionality and interfaces that are required to support a particular ITS or connected vehicle service package / application.

In SET-IT, after you Create a New Diagram, or open an Existing Diagram.

Select the **Functional Object** from the stencil on the left.

Drag the **Functional Object shape** to the diagram area into one of the Physical Object shapes already on the diagram.

Double click on the Functional Object.

Shape properties form appears on the left.

Select appropriate **Status** from the pull-down menu on the bottom.

Click the **New** button in the shape properties.

Select a **Functional Object** name on the list.

The selected **Functional Object** name will appear on the shape.

NOTE: If the functional object is in a subsystem kind of physical object which means that it has functionality defined by ARC-IT or as a user defined object then Shape Properties will show the functional objects mapped to that physical object along with generic functions that support the object based on its class. If a shape is a terminator kind of physical object which means that it lies on the boundary of what is considered ITS in ARC-IT, then it will not show any functional objects for selection.

NOTE: All subsystem physical object shapes will also have the ITS class functional objects which includes the basic communications, management, and security functions common to all ITS objects. Center and Field class shapes will also make the generic center and field functional objects available for selection.

NOTE: You may need to press the "Refresh" button at the top of the Shape Properties window. When you do the selected functional objects will move to the top of the list.

NOTE: if you change the status of a functional object on one diagram its status will change on other diagrams where that same functional object is used. The exception to this occurs when a shape is mapped to more than one element on one diagram but only one element on another diagram then the Sync function will not try to change the status of a multiply mapped shape. It can only show one Status value (the one that was previously set for that Functional Object shape)

Add a Hyperlink

Hyperlinks provide a way to automatically link terms or objects in your SET-IT project to another location or file, perhaps to another location on the internet. From the Information Flows, Physical Objects, physical Functional Objects, and enterprise Resources windows click on the Hyperlink button and you will see the following screen:

The first time you will need to add a hyperlink by pressing the Add/Edit button at the top left of the Hyperlink screen:

Hyperlink Name	Hyperlink Address	Hyperlink Description
CVRIA Program Website	https://www.standards.its.dot.gov/Deve	Provides overview and background of the CV Reference Architecture.

In the 3 columns on the Hyperlinks details screen you can enter the following:

- Hyperlink Name - is the readable text you want your readers to see in the documentation, e.g., "Architecture Team Website."
- Hyperlink Address - is the fully qualified Uniformed Resource Locator (URL), e.g., "<https://www.standards.its.dot.gov/DevelopmentActivities/CVReference>".
- Hyperlink Description - is a place for you to provide any additional descriptive text explain what the link is used for or where it's located, e.g., "provides resource material used as background for this project".

Can I draw my own Layer 2 diagram without an ARC-IT service package?

Yes, you can also start from scratch, that is, create your own layer 2 drawing.

You can use the stencil to drag physical objects onto the diagram and flows to build your own 'service' or 'application' of sorts. Refer to the directions above about how to use each of the diagram tools.

You can also drag Functional Objects onto the drawing. When you place the blank Functional Object over one of the Physical Object shapes SET-IT will populate the Shape Properties with the appropriate functional objects. The list may be blank if there are none defined for that physical object in ARC-IT, e.g., a Driver or an external object with respect to the ITS architecture like a Financial Institution.

You can use terminals to help unclutter a diagram and add Notes.

The title box also works the same on a from-scratch Layer 2 diagram as it does on other diagrams: (use the Update Title to automatically update the title, date, etc.).

Diagram Clean-Up Tool

There is a diagram clean-up tool on the main toolbar to help you remove shapes that are on the diagram but are not necessary because you have decided they are not applicable.

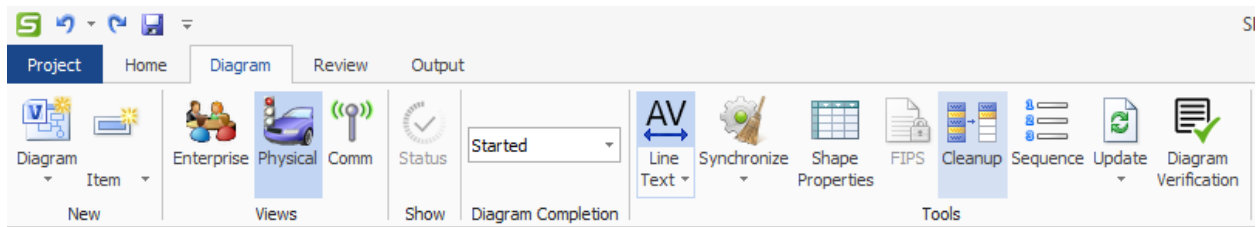

You can also create versions of the diagram that show only the Existing and another diagram that shows only Project status flows.

The Diagram Cleanup window includes a pull-down to select the current diagram, all physical Layer 2 diagrams, or the diagrams you select using the checkboxes on the screen.

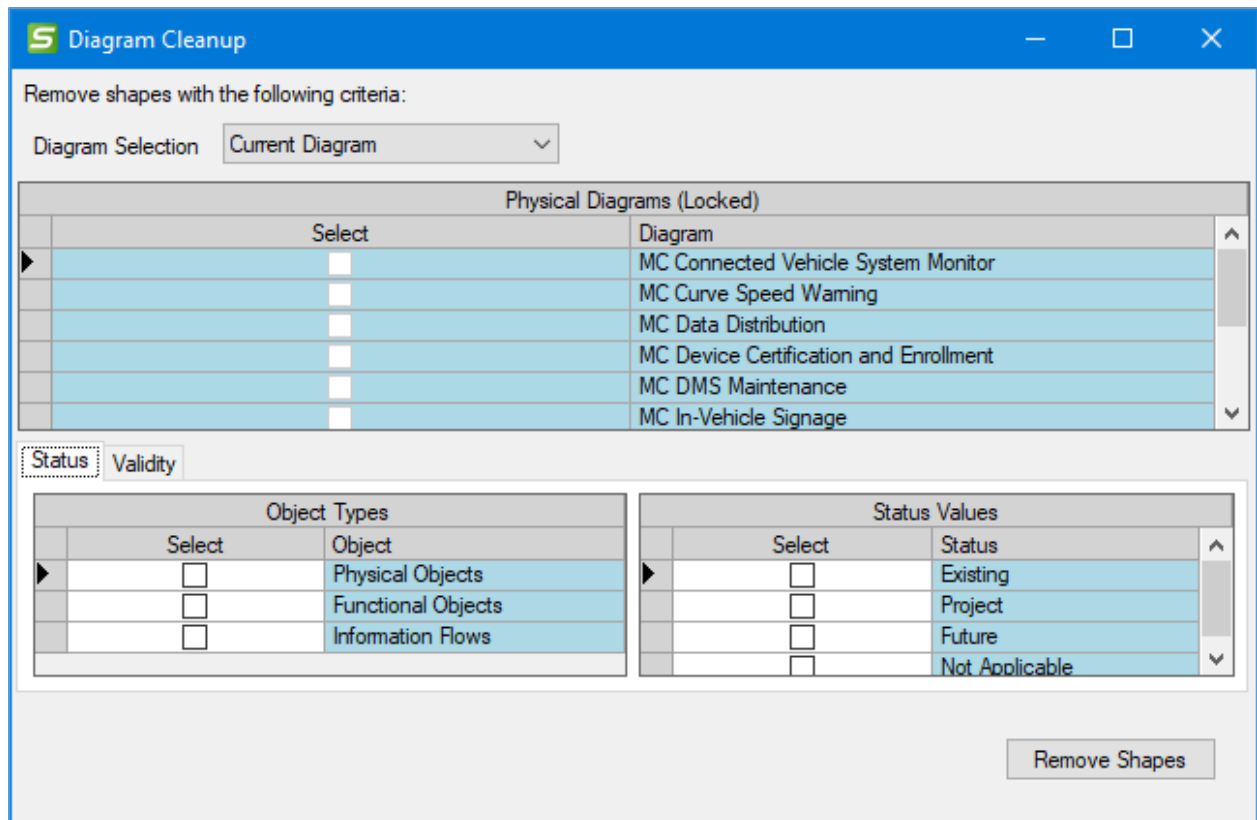

The Validity sub-tab shows additional checks:

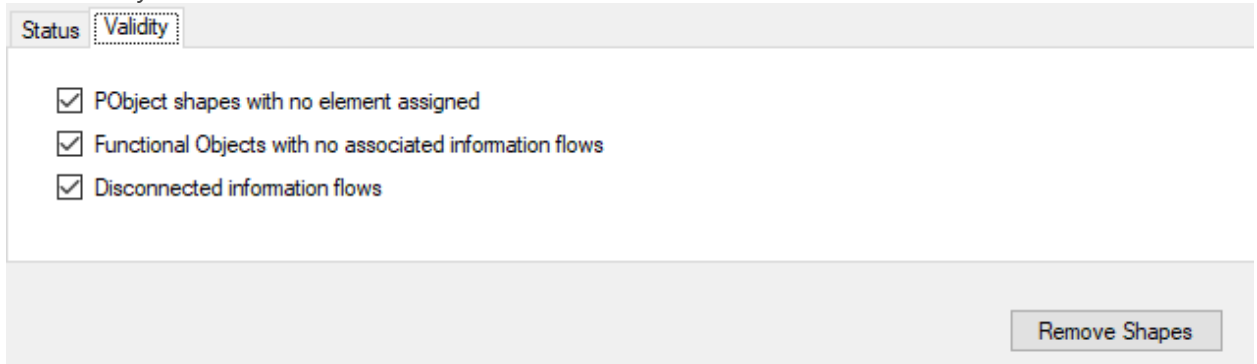

The new Validity tab includes 3 validity-based cleanup actions, including the removal of:

- Physical Object shapes with no elements assigned,
- Functional objects with no associated information flows, and
- Disconnected information flows.

The "Remove Shapes" button will remove shapes that fail the checked validity tests on the identified set of diagrams (with default to the current diagram).

TIP: make a copy of your project first and zip that so you have a record of your project before the cleanup exercise.

NOTE: The Diagram Cleanup tool is only available for Layer 2 (service package level) diagrams. Use the Update Diagram tool to reorganize and update the contents of the higher-level diagrams, Layer 0 or Layer 1.

Diagram Completion Verification

The Diagrams menu on the left uses colors to show the completion of a diagram.

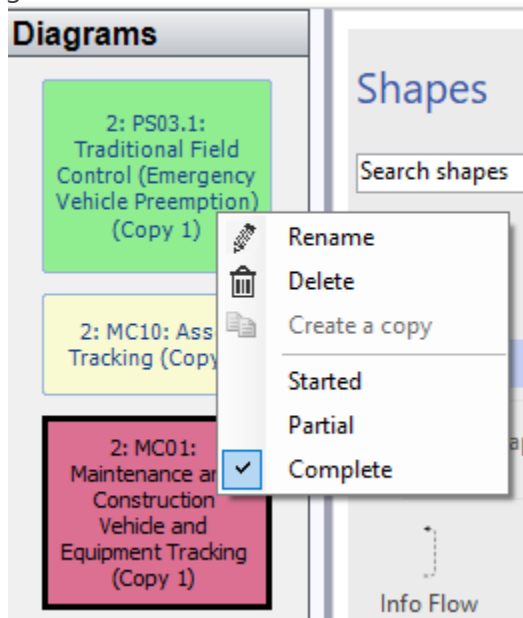

The other way to change the Completion of a Diagram is to use the pull-down menu from the toolbar.

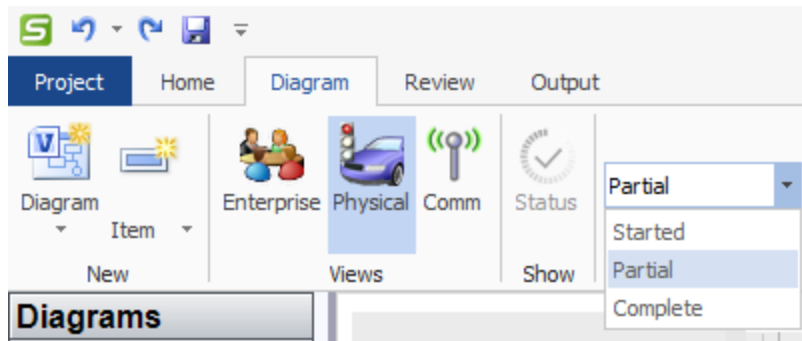

When you first include a service package the color will be set to Red to show that it is 'Started'. If you select Partial then the color will change to Yellow. If you select Complete it will change to Green but only after SET-IT checks to see if it passes the required verification tests. If not, you will see an Incomplete Diagram warning box and you will be told to use the Diagram Verification Preview tool to locate and fix the issues.

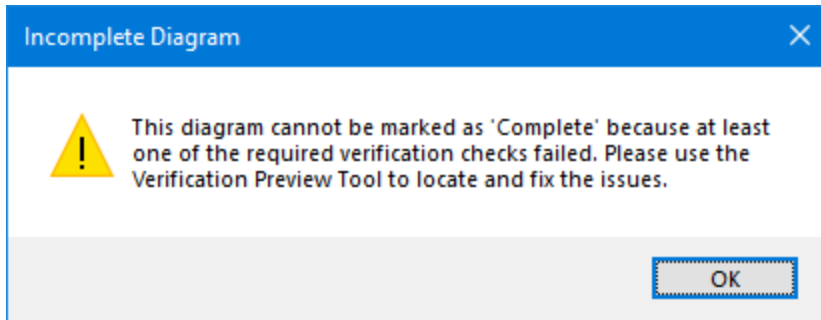

SET-IT will monitor diagram changes that can impact completion status and rollback diagram completion status from "Complete" to "Partial" if such changes are detected. Diagram changes that can impact completion status are:

- Manual edits that add, delete, or modify PObject, FObject, or Flow shapes. Manual changes that add comments or edit the title block are examples of changes that shouldn't cause completion status to rollback.
- Sync changes that add, delete, or modify PObject, FObject, or Flow shapes. For example, a sync change that removes a deleted element from a shape would cause completion status to be rolled back for that diagram. A simple rename of an element that is synced into a diagram ideally should not cause completion status to be rolled back.

The Diagram Verification tool is located at the top menubar in the Tools section of buttons.

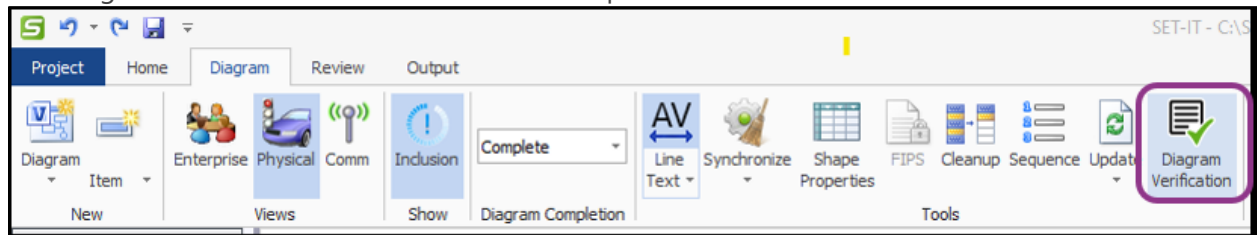

Click that button to launch the Diagram Verification tool

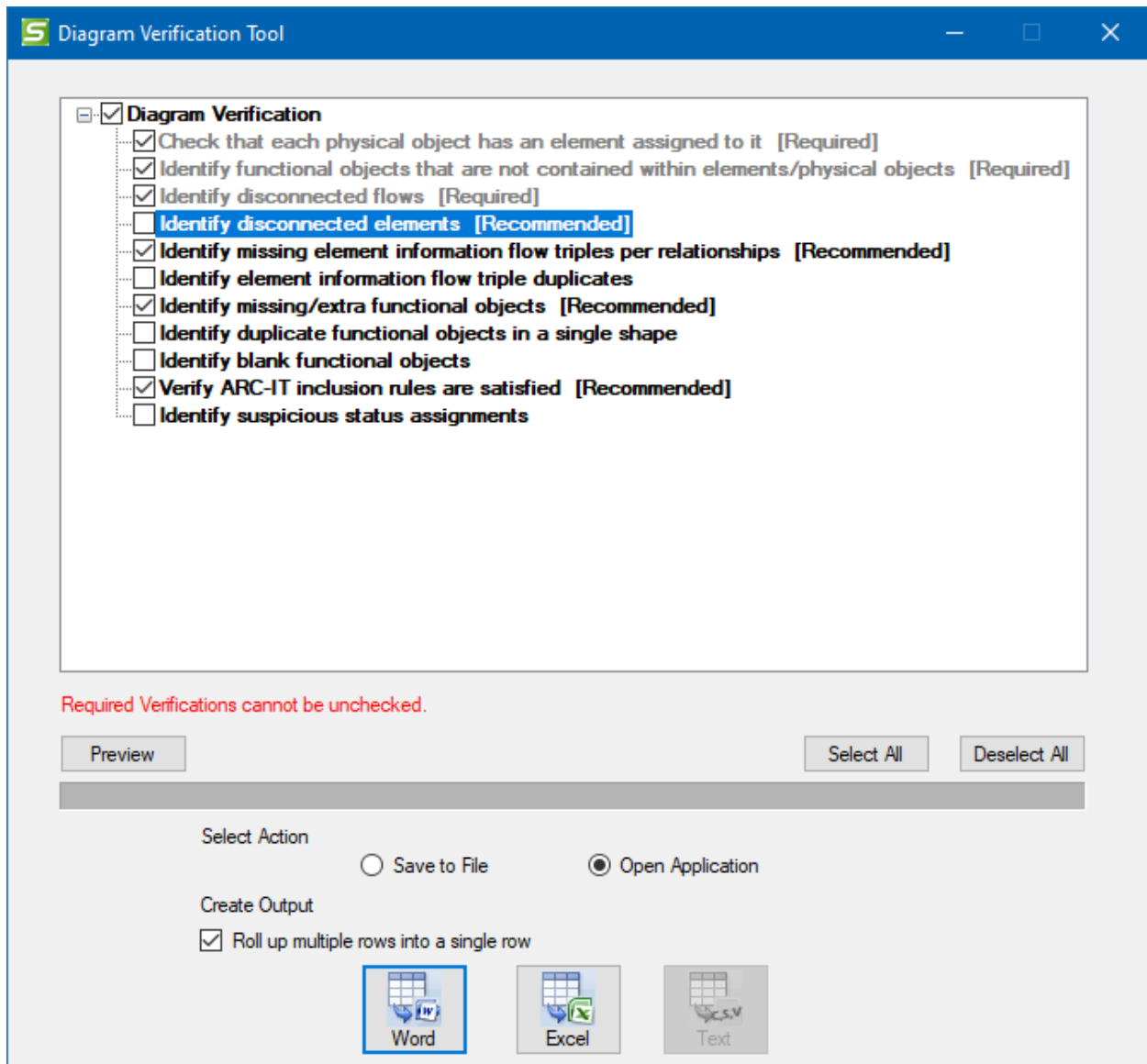

A number of tests are listed. Some are Required or considered a minimum set of tests for completion and are not selectable or de-selectable by the user. Others are *recommended* and others are optional but they may help you determine what needs to be completed in your project.

The Select All and Deselect All buttons can be used as short-cuts to check or uncheck all the boxes.

Use the Preview button to bring up window that shows the results right away or use the buttons at the bottom of the Diagram Verification window to create the outputs in Word, Excel, or Text format as with other outputs.

The Preview screen is useful to have it open and you can set it to automatically Refresh as you make corrections and changes to your diagram.

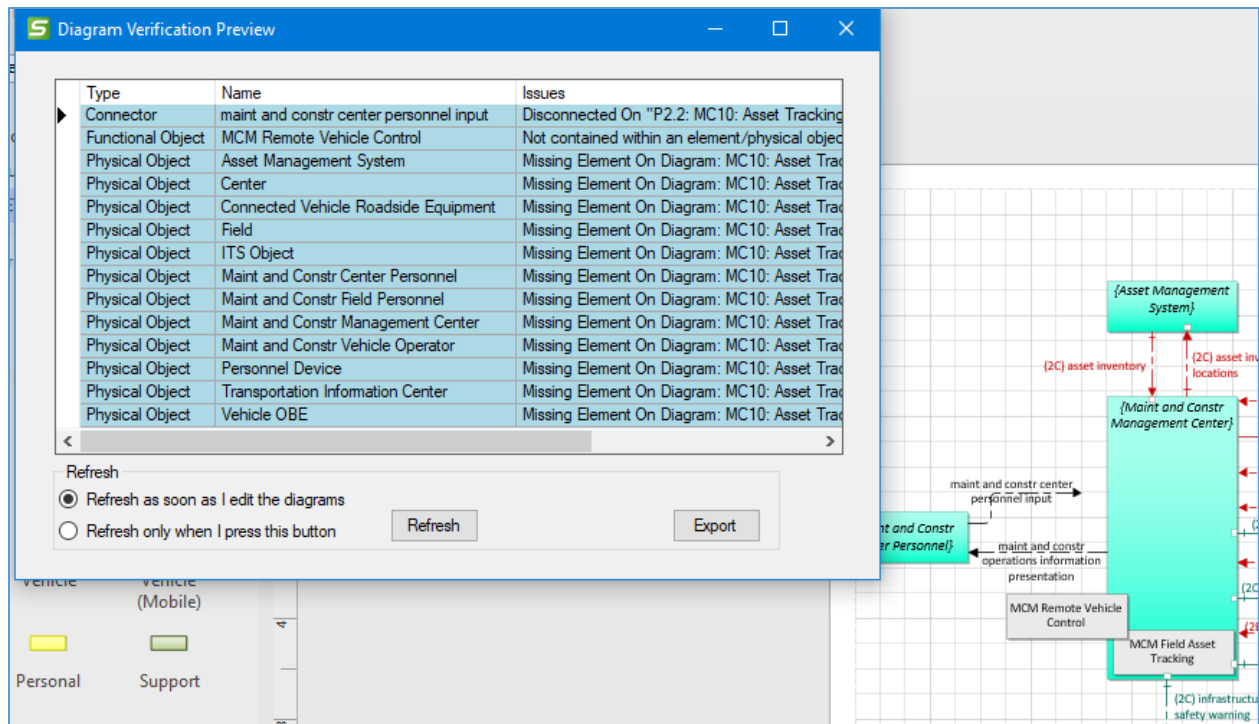

As you make corrections to your diagram – adding elements, connecting loose flows, putting functional objects back in their place the issues will disappear from the Preview window. You can also choose to Refresh only when you press the “Refresh” button – this may help with the performance of the tool if you have a large project. You can also click the “Export” button to launch the output screen as with other outputs in SET-IT.

Status of Multiple Shapes

Using Shape Properties for a Layer 2 diagram you can set the status for all shapes or elements at the same time. This may be useful if you've been making changes individually but decided that everything needed to have the same status – maybe a project is now done and you need to show everything in the diagram as existing. Or the opposite – a part of the project has been deferred and you need to show that service package as having been moved out into the future.

Start by selecting a diagram in Physical view.

Next, select all the shapes you want to have that same status, including Elements, Flows, or Functional Objects within the selected Elements.

Then bring up Shape Properties, either by clicking Shape Properties from the menubar or by right-clicking one of the selected shapes and clicking Shape Properties.

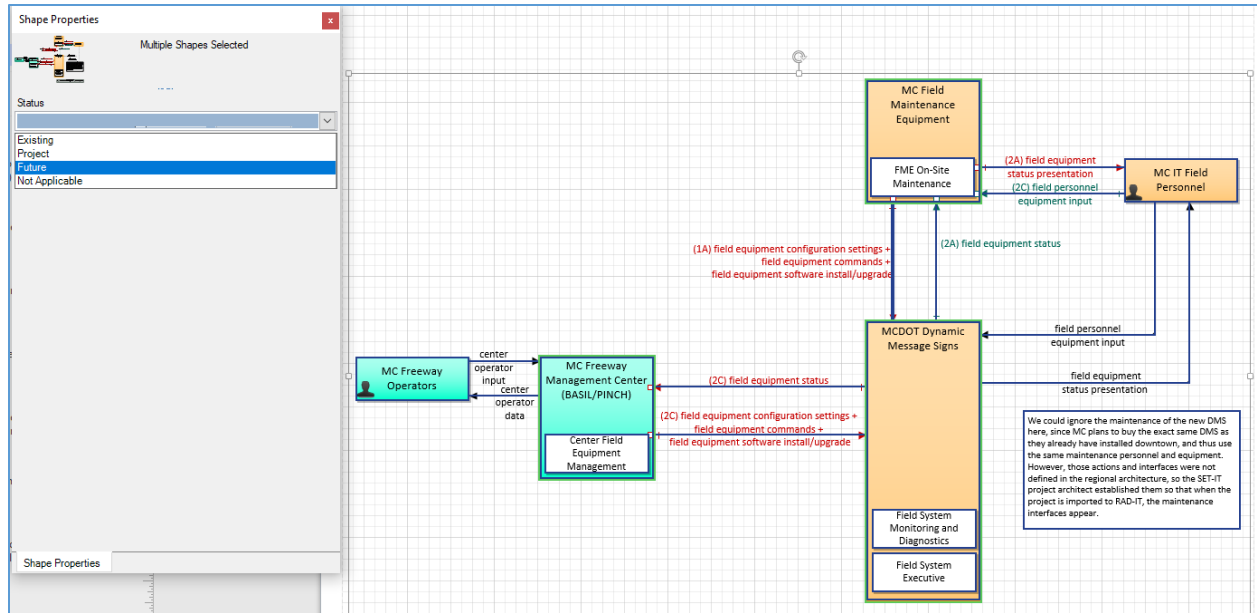

In this situation Shape Properties will come up with only one attribute to change, Status. Use the pull-down to change the status of all the selected shapes.

Drawing Higher Layer Physical Diagrams

When a project spans more than one service package it will be good to see a summary of the project that includes all of the elements involved in the project. This can be done by using SET-IT to create an aggregate or Layer 0 or Layer 1 diagram to show the physical elements and their interconnects.

NOTE: you will need to completely customize your Layer 2 diagrams and set its Completion Status to “Complete” before being able to include that in a Layer 0 or Layer 1. If you don’t need an element for a particular object just remove that box and the flows going to or from it. The Diagram Verification tool can help show what needs to be fixed before completing a layer 2 diagram.

Layer 0 diagrams show all of the physical elements in a project and which ones are connected to each other via communications *links, known as Physical Interconnects or P-Interconnects*. They are also created from Layer 2 service package diagrams but unlike Layer 1 they don't include any functional objects. The Layer 0 drawing may be more helpful to external stakeholders or decision makers to quickly see the scope of a project.

For **Layer 1 Diagrams** SET-IT will take the Layer 2 service package diagrams that you choose and come up with the combined set of physical objects and all of their functional objects that are needed to support the various service packages in which they are involved. The Layer 1 diagrams will also include *physical interconnects* between those objects.

SET-IT will place the elements on the Layer 0 or Layer 1 diagrams and will attempt draw the lines as best it can. In many cases, the user may need to rearrange the lines and elements to look

presentable and legible. Many of the objects on a Layer 0 or Layer 1 diagram are read-only. Use the Layer 2 diagrams to edit the shapes then use the Update Diagram tool if necessary to make modifications to the higher layer diagram.

Physical Interconnects can have an alias assigned on the P-Interconnects definitions table in the Definitions menu. If an alias has been applied then the alias name will appear on all diagrams where that same P-Interconnect is used.

The elements on a Layer 0 diagram are smaller versions of their Layer 2 or Layer 1 counterparts.

Layer 0/1 Settings

Layer 0 and Layer 1 diagrams are generated by SET-IT in real-time instead of being pre-imported from ARC-IT.

There is a Settings window for either Layer 0 or 1 diagram to allow you to change the appearance of the drawing.

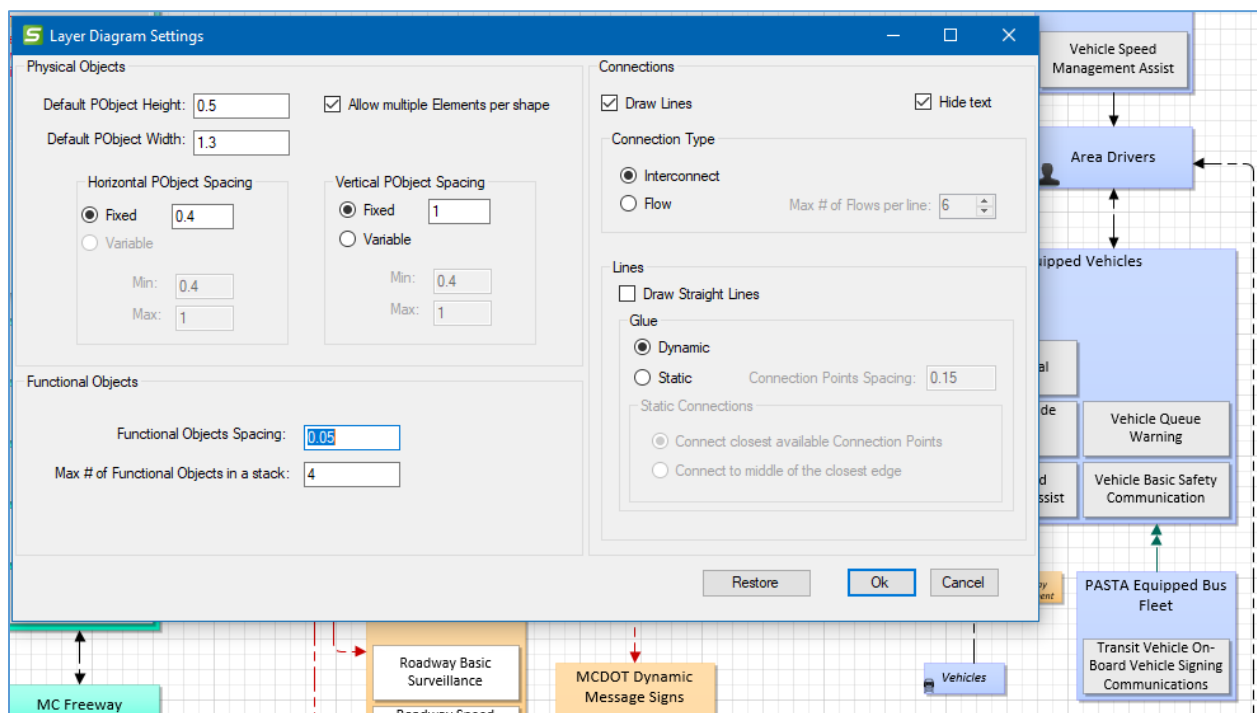

As you click New / Diagram and choose either Layer 0 or Layer 1 you will see a Settings button. The Settings button launches a new screen called the Layer Diagram Settings window. It has options for shapes and lines.

For the shapes you can manipulate the following:

- Spacing between connection points
- Spacing between functional objects (on a Layer 1)
- Maximum number of functional objects (on a Layer 1) to include in a single stack

- As the number approaches that maximum the diagram generator will then widen the Element box to include a 2nd or 3rd column of functional objects.
- Default height and width of physical objects and/or elements
- Spacing, either fixed or variable, between physical objects and/or elements
 - If it is fixed, you can say by how much and if it is variable you can give it a minimum or maximum distance

For the lines you can choose to show interconnects or flows and then you can manipulate the following settings:

- Whether or not it should even bother with drawing lines
 - Perhaps you're going through this in iterative steps and want to focus on the placement of the physical objects or element shapes first.
- Whether the line should be straight, creating a star effect or the traditional lines with bend points between source and destination
- Whether the 'glue' that is used to stick or connect them to the source and destination shapes is static or dynamic
 - If dynamic, then SET-IT will decide where the end point should be.
 - If static, you can tell SET-IT whether to connect the line to the closest available connection points or to the middle of the closest edge.
- How many flows (if you selected Flow mode) to include on a single line
- Spacing between connection points on the shapes
 - Smaller numbers mean you can have more places to connect flows/interconnects to a shape and reduce the chances of overlaps.

TIP: these settings are for an advanced user. Save and Export a zipped copy of your project before starting to manipulate the settings on your diagram. It's also a good idea to try it with the default settings first as that may be just fine for your needs.

You can click the Restore button to restore the settings back to their original defaults.

Behind the Scenes on Layer 0/1: SET-IT's diagram generation algorithms will try to build a diagram that is oriented similarly to the layer 2 diagrams that came from ARC-IT. It will try and put the Centers and Support objects on the left and Mobile devices on the right. If a DDS is in the project, it will put that to the right of the centers and Field devices will be in the middle of the drawing. It will then place the shapes where it makes the most sense in terms of what they are connected to. You will probably still need to move shapes around in order to fit onto a reasonably sized image.

During the diagram generation process you can click "Cancel" to stop it and go back to the Diagram window.

NOTE: Layer 0/1 drawings are not editable in the same way Layer 2 drawings are. You can move shapes around and delete them if desired, but you cannot add shapes from the stencil. To add additional items to a layer 0/1 drawing you will need to regenerate the diagram and reselect which layer 2 drawings to choose.

NOTE: From time to time you may get a message during diagram generation that says "Failed to merge the related shapes for the following elements:"

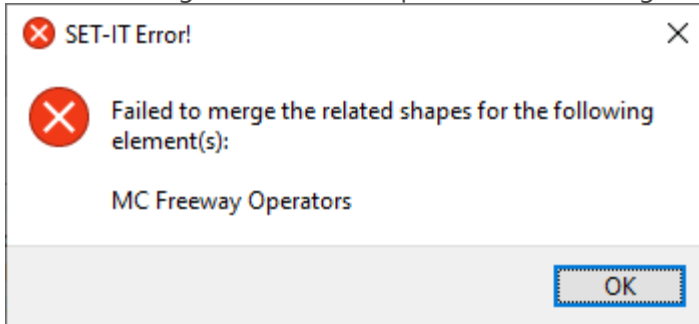

The error message indicates that there are more than one Layer-2 shapes representing "MC Freeway Operator" element AND those shapes do not have any common Physical Objects. Therefore, the Layer1/0 generator fails to combine them.

The Layer 1/0 generator will combine similar shapes with minor differences as long as they have at least one common Physical Object, for example if you have an "ABC" element that appears as a {TMC+Center} on one Layer 2 diagram and as a {TIC+Center} on another Layer 2 diagram, then L1/0 generator will create a shape for "ABC" element that is mapped to {TMC+TIC+Center} Physical Objects. The solution to avoid the message above is to go back to one of the layer 2 diagrams with that element and add a mapping using Shape Properties to the Physical Object that element is mapped to on one of the other diagrams.

Layer 0 Specific Instructions

While many of the basic SET-IT diagram features apply equally at all physical layers there are some rules or techniques that only apply to Layer 0.

What is a Layer 0 diagram?

A Layer 0 diagram is a high-level drawing used to show the Physical Objects or Elements from your project and how they are connected. That's it. It's a summary of what lies beneath. It helps the project team and stakeholders reviewing the system documentation to see just what all of the systems are and how, at a very high level, they are connected.

How is a Layer 0 Diagram Drawn?

Typically, users will want to create a Layer 0 diagram after they have completed their Layer 2 service-level diagrams. Then when you use the New/Diagram/Layer 0 dialog you will see all of your service packages pre-selected.

You can un-select service packages that you don't want included – perhaps they aren't complete or won't be part of the specific phase of the project you are embarking on at the time.

NOTE: you will need to completely customize your Layer 2 diagrams before being able to include that in a Layer 0. If you don't need an element for a particular object just remove that box and the flows going to or from it.

As shown in the screen below the layer 2 drawings that have not been completely customized will be greyed-out and unselected.

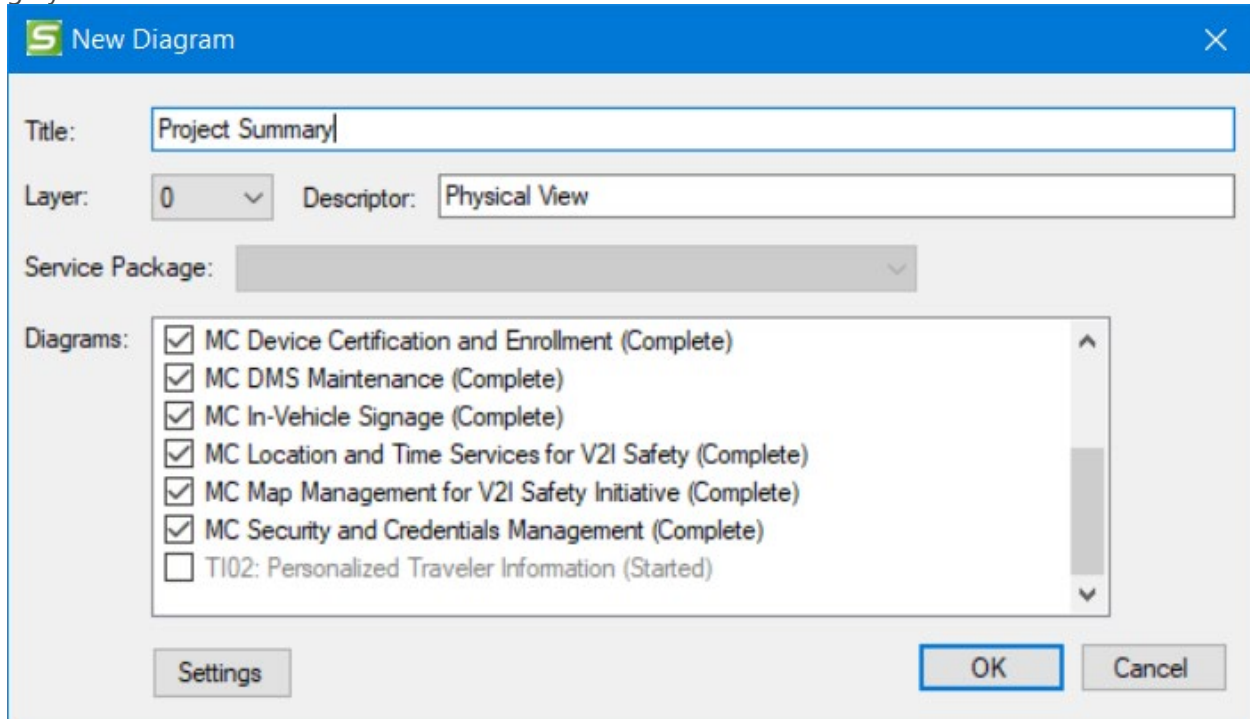

Go back to that layer 2 and add elements for each shape, change its Diagram Completion to Complete, and return to this screen.

Can I Draw My Own Layer 0?

SET-IT is designed so that the Layer 0 is a summary of your Layer 2 service package-based diagrams. It asks that you include at least one fully customized service package (layer 2) diagram to initiate a Layer 0 drawing but then you can use the stencil to drag shapes like Terminals, Comment Clouds, Legends, or Note Boxes onto the diagram in order to make the diagram more presentable and communicate ideas and notes with reviewers.

What's on a Layer 0?

There are some differences about a Layer 0 from a Layer 2 drawing on the physical view. For one, Flows are typically replaced with Interconnects. The types of Physical Interconnects, also called Links in ARC-IT, used on Layer 0 and Layer 1 include:

Center to Center	Human Interface	Remote Access Human Interface
Center to Field	Low Power Radio Broadcast	Short Range Wireless
Contact or Proximity	Network Time Protocol	Vehicle On-Board
Environment	Personal Area Network	Wide Area Broadcast
Field to Field	Position Location Interface	Wide Area Wireless

The shape properties window will show which interconnect is selected and list its characteristics. It will be a Read Only view. The details form will also show you what information flows are included in that interconnect.

NOTE: Not every flow maybe listed under the interconnect. Some flows like “data publication” are known as ‘superflows’ which are simply collections of information flows defined in ARC-IT that are being carried between elements over some communications path.

On a Layer 0 drawing, time and spatial context values represent the range of values for the flows that make up that interconnect. For instance, if that interconnect is made up of 3 information flows that range from Now/Local to Historical/National then the Layer 0 P-Interconnect will show "1-3,B-D".

In each case, the attributes of the interconnect are locked (you can't edit them) because they will be assigned based on the flows upon which it is based:

- Status: Existing, Project, New Opportunity
- Encryption: True, False
- Authenticability: True, False
- Cardinality: Unicast, Multicast, Broadcast

Just as with other drawings you can use Terminals to help unclutter a diagram and add Notes or Comments.

The title box also works the same.

Notes, Tips, and Caution for Layer 0s:

NOTE: Layer 0 drawings do not include Functional Objects (the small white or grey boxes inside the physical objects). They will be on the Layer 1 or Layer 2 drawings.

TIP: Once SET-IT has drawn your layer 0 for the first time it is a really good idea to go around and click each element box and click “Connection Points” on the menubar. This will give you more connection points to connect lines to and it will make editing the diagram much easier.

CAUTION: Creating or modifying a Layer 0 diagram on your own may be helpful to sketch ideas out but beware. You may not be able to keep things synchronized between the layers. For instance, disconnecting an interconnect while you rearrange the shapes may result in an inconsistency between the layers. SET-IT's validation tools will help sort these out.

CAUTION: Lastly, as the number of service packages (Layer 2s) in your project grows so will the size and complexity of your Layer 0 drawings. SET-IT will attempt to place objects in a logical place and route the interconnects as best it can but you will need to edit these yourself. You can also create more than one Layer 0 drawing to highlight key subsets of the project, e.g., transportation services vs the support services.

Layer 1 Specific Instructions

While many of the basic SET-IT diagram features apply equally at all physical layers there are some rules or techniques that only apply to Layer 1.

Like Layer 0 described above, Layer 1 drawings provide a higher-level summary of what all is included in your service package. Now at Layer 1 we can show all of the *functional objects* that will be running or reside in the physical objects or elements of your project.

It helps the project team and stakeholders reviewing the system documentation to see just what all of the systems are doing across all of the services or applications and the interactions (physical interconnects).

NOTE: you will need to completely customize your Layer 2 diagrams before being able to include that in a Layer 1. If you don't need an element for a particular object just remove that box and the flows going to or from it.

As shown in the screen below the layer 2 drawings that have not been completely customized will be greyed-out and unselected.

Go back to that layer 2 and add elements for each shape, change its Diagram Completion to Complete, and return to this screen.

How is a Layer 1 Diagram Drawn?

Typically, users will want to create a Layer 1 diagram *after* they have completed or nearly completed their Layer 2 service-level diagrams. Then when you use the New/Diagram/Layer 1 dialog you will see all of your service packages listed but not selected.

That's a key difference between Layer 0 and 1. At layer 0 SET-IT assumes you want to see everything in one picture. At Layer 1, SET-IT is assuming you may want to create multiple Layer 1s depending on areas of focus so it lets you pick the Layer 2 drawings to include.

Can I Draw My Own Layer 1?

SET-IT asks that you include at least one service package to initiate a Layer 1 drawing. You can use the stencil to add Notes, Comments, Terminals, or Legends to your diagram. This still gives you the ability to customize your diagram and, with terminals, to make a complex drawing more readable.

On a Layer 1 you can edit the diagram by moving shapes around to get the placement you want, and you can reconfigure the interconnects to suit your needs.

CAUTION: Lastly, as the number of service packages (Layer 2s) in your project grows so will the size and complexity of your Layer 1 drawings. SET-IT will attempt to place objects in a logical place and route the physical interconnects as best it can, but you will need to edit these yourself.

Can I Create My Own Physical Interconnect?

No. Every information flow triple, even user defined triples, are mapped to one of the physical interconnects defined by ARC-IT.

The types of Physical Interconnects, also called Links in ARC-IT, used on Layer 0 and Layer 1 include:

- Center to Center
- Human Interface
- Remote Access Human Interface
- Center to Field
- Low Power Radio Broadcast
- Short Range Wireless
- Contact or Proximity
- Network Time Protocol
- Vehicle On-Board
- Environment
- Personal Area Network
- Wide Area Broadcast
- Field to Field
- Position Location Interface
- Wide Area Wireless

Reviewing Your Physical Interconnects

While you cannot use the method of dragging lines/interconnects from the stencil onto a diagram, you can double-click on a line to bring up Shape Properties to view its characteristics.

SET-IT will show type of Physical Interconnect used. For example, on a line between two field devices you will see that SET-IT assigned the "Field to Field" interconnect.

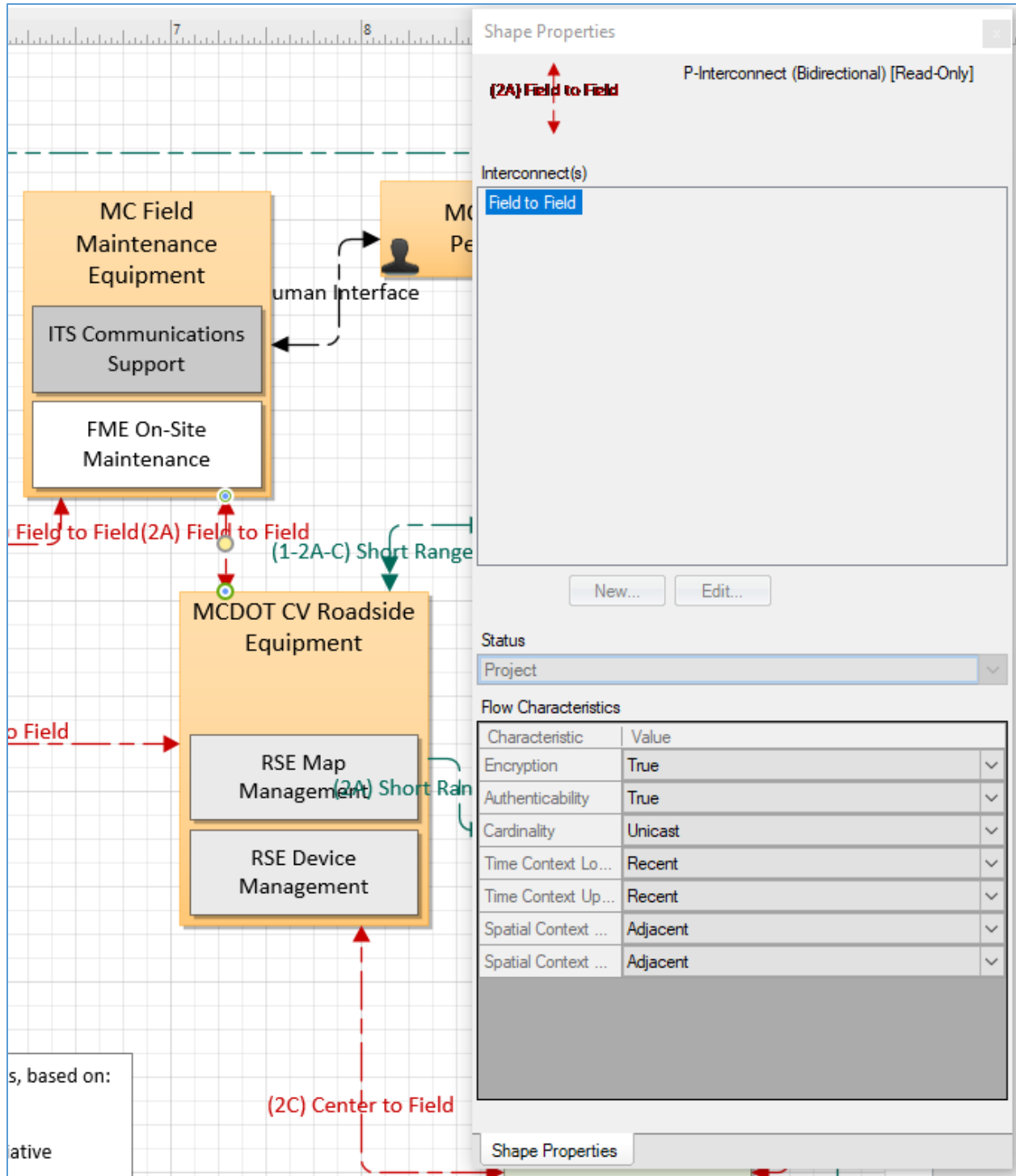

The shape properties window will show which interconnect is selected and list its characteristics. It will be a Read Only view.

Go to the Definitions menu and open the P-Interconnect Triples grid. In the Physical Interconnect Details form, you can view the Information Flows included in the interconnect and the characteristics for that interconnect.

P-Interconnect Details

Name: Center to Center

Alias: BackOffice to BackOffice Apply Alias

Description: A communications link that provides communications between centers. It may be implemented using a variety of public or private communication networks and technologies.

Encryption: True Using FIPS

Authenticability: True Time Context Lower Bound: Recent Time Context Upper Bound: Recent

Cardinality: Unicast Spatial Context Lower Bound: Regional Spatial Context Upper Bound: National

FIPS

Confidentiality: Integrity: Availability:

Source Element	Destination Element	Status
Digital Map System	MCDPW GARLIC Information System	Project
Digital Map System	MC Freeway Management Center (BASIL/PINCH)	Project
MCDPW GARLIC Information System	Security Credentials Management System	Project
MCDPW GARLIC Information System	Martara County Data Sharing System	Project
MC Freeway Management Center (BASIL/PINCH)	MCDPW GARLIC Information System	Project
MC Freeway Management Center (BASIL/PINCH)	Security Credentials Management System	Project

Layer 2 Information Flow(s)

data provision	equipment maintenance status	MAP (intersection geometry)
data publication	field device maintenance coordination	TMDD (current infrastructure restrictions)
data query	map update notification	
data query publication	map updates	
data subscription	misbehavior report	
device enrollment information	security credential revocations	
enrollment credentials	security credentials	
equipment maintenance request	security policy and networking information	

Form Source: Grid - P-Interconnects

NOTE: Not every flow maybe listed under the interconnect. Some flows like “data publication” are known as ‘superflows’ which are simply collections of information flows defined in ARC-IT that are being carried between elements over some communications path. Also, if your flows were routed through a communications element or a data distribution element then they will appear in 2 P-Interconnect Triples – the one going to the Comm or Data element and the one on the other side of the Comm or Data element.

The attributes or characteristics of the interconnect will be assigned based on the flows upon which it is based:

- Status: Existing, Project, New Opportunity
- Encryption: True, False
- Authenticability: True, False
- Cardinality: Unicast, Multicast, Broadcast

Notes, Tips, and Caution for Layer 1s:

NOTE: Layer 1 drawings include Functional Objects (the small white or grey boxes inside the physical objects). Currently the status value is fixed and so the coloring cannot be changed.

TIP: Once SET-IT has drawn your layer 1 for the first time it is a really good idea to go around and click each element box and click “Connection Points” on the menubar. This will give you more connection points to connect lines to and it will make editing the diagram much easier.

CAUTION: Creating or modifying a Layer 1 diagram on your own may be helpful to sketch ideas out but beware. You may not be able to keep things synchronized between the layers. The Layer 1 template and Shape Properties on Layer 1 limits how much can be customized and edited.

CAUTION: Lastly, as the number of service packages (Layer 2s) in your project grows so will the size and complexity of your Layer 0 or Layer 1 drawings. SET-IT will attempt to place objects in a logical place and route the interconnects as best it can, but you will need to edit these yourself.

Enterprise View

This section describes how to create and modify your architecture's enterprise view, including how to create a new Enterprise diagram and modify its components. The Enterprise View addresses the relationships between organizations and users, and the roles those 'enterprises' play in the delivery and consumption of ITS services. Relationships between 'enterprises' or stakeholders, as they are known once you customize the architecture, are dependent on the roles they take in the delivery of user services.

An Enterprise view consists of drawings at the overall project level (Layer 0). The components of an Enterprise diagram include:

- Enterprise Objects, boxes with solid lines, will be related to project Stakeholders.
- Resources, boxes with dashed lines, will be related to physical objects or elements from the physical view as well as some functional objects (internal subset of functionality within a physical object).
- Agreements, red lines, represent a type of relationship between stakeholders or enterprise objects (the boxes) in a project.
- Expectations, blue lines, represent another type of relationship between stakeholders or enterprise objects in a project.
- Roles, black lines with a solid circle on one end, represent a relationship between a stakeholder and their elements, e.g., who *owns* or who *manages* an element.
- Member, black lines with a clear diamond on one end, represent a relationship in which one stakeholder is a Member Of a group of stakeholders.

The key questions to be understood by the development of an enterprise view for a project include "Who owns or who manages which components of the overall system" and "How are they related to each other?" In other words, what agreements need to be in place for the system represented in the physical view to work?

TIP: Typically, SET-IT users will start by selecting one or more ARC-IT service packages for their project and begin customizing the *Physical* view. Once elements have been defined for each object in the physical diagram and stakeholders have been defined along with their relationships (Owns/Manages) to the elements then enterprise can start to take shape.

NOTE: A physical layer 0 diagram must be created before creating an enterprise layer 0 diagram.

Once the Physical View is populated and the Enterprise View is entered – either by creating an Enterprise Diagram or going to one of the Enterprise View grids – a set of Rules is executed to generate the appropriate relationships. The agreements are established based on the Enterprise View in ARC-IT.

Agreements can be classified by their 'Specificity', either a "General" or a "Specific" agreement. General agreements are typically applied broadly and perhaps include more than just 2 stakeholders, perhaps everyone involved in a project or initiative. Specific agreements are typically centered around an interface or system element being developed or used in some way. The table below lists the General and Specific Agreements that come out of ARC-IT's Enterprise View

Table 1. ARC-IT Enterprise View Agreements

Specificity	Name
General	Funding Agreement
General	Handshake Agreement
General	Interagency Agreement
General	Master Agreement
General	Memorandum of Understanding
General	Project Blanket Agreement
General	Service Package Blanket Agreement
General	Shared Operations Agreement
General	Unspecified
Specific	Acquisition Agreement
Specific	Application Interface Specification
Specific	Application Usage Agreement
Specific	Device Placement and Operations Agreement
Specific	Device Usage Agreement
Specific	Employment Agreement
Specific	Equipment Operations Agreement
Specific	Information Exchange Agreement
Specific	Information Exchange and Action Agreement
Specific	Information Provision Agreement
Specific	Information Provision and Action Agreement
Specific	Installation Agreement
Specific	Interface Description
Specific	Maintenance Data Exchange Agreement
Specific	Operations Agreement
Specific	Security Credentials License and Usage Agreement
Specific	Service Coordination Agreement
Specific	Service Delivery Agreement
Specific	Service Usage Agreement
Specific	System Maintenance Agreement
Specific	System Monitoring Agreement

Specificity	Name
Specific	System Usage Agreement
Specific	Vehicle Data Access Agreement
Specific	Vehicle Operating Agreement
Specific	Verification Agreement
Specific	Warranty

For interface related agreements SET-IT looks at the stakeholders who 'own' elements on both sides of each interface in the architecture. If they are the same, then no agreement is necessary, such as when the State DOT is sending configuration data from its center down to its field equipment. On the other hand an agreement is needed if the State DOT is sharing control with another DOT center. The agreement types and the generic text are from ARC-IT's Enterprise View. The Enterprise View in ARC-IT describes the relationships between organizations and the roles those organizations play within the transportation environment. Some agreements are needed for one organization to provide information to another; some agreements need to be defined in such a way that not only is information provided but an action is expected to take place with the information. These are among the agreements that ARC-IT will define and display when a user enters the Enterprise View after making changes in the Physical View.

Another type of agreement is formed when one stakeholder 'owns' a resource/element but another stakeholder 'manages' that same resource/element. There will then need to be a management agreement between them. Similarly, owners and maintainers of the same element will need a system maintenance agreement.

TIP: The Enterprise Layer 0 diagram is a useful addition to a Concept of Operations document as it shows the overall set of Stakeholders and their relationships to each other.

Create a New Enterprise Diagram

An Enterprise Layer 0 diagram is a high-level drawing used to show the Enterprise Objects or Stakeholders from your project and how they are related. That's it. It's a summary of what lies beneath. It helps the project team and stakeholders reviewing the system documentation to see just who all of the stakeholders are and their relationships.

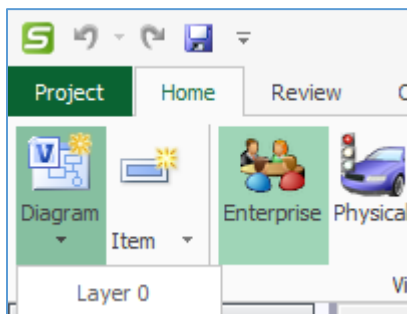

To create a new Layer 0 diagram:

1. Click on the **Diagram** tab.
2. Select a **Layer** from the drop-down menu. For Enterprise the single choice is Layer 0 for the project level perspective.
3. To create a Layer 0 diagram, in the **New Diagram** box:
 - a. Enter the title of the new diagram.
 - b. Select Layer 0 with the pull-down.
 - c. Select the physical layer 0 diagram that you already created and customized to use as the basis for the enterprise diagram.
 - d. Optionally, modify the Settings for the diagram – See options on the [Enterprise Layer Diagram Settings Window](#).
 - e. Click OK.

NOTE: you must have already created a Physical Layer 0 drawing before creating an Enterprise Layer 0 drawing. Otherwise, you will get a warning that "No physical layer 0 diagram has been selected" and it will ask if you would, "Like to create a blank enterprise layer 0 diagram."

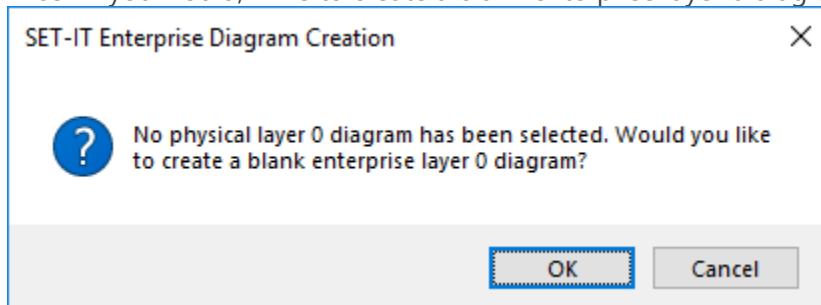

It is probably best to go to Physical and create a Layer 0 diagram for your project and then come to enterprise to create the Layer 0 diagram.

NOTE: You can only select one Physical Layer 0 drawing on which to base your enterprise layer 0 diagram.

If you picked a physical layer 0 diagram that you had already created, SET-IT will use those elements to create resources and any stakeholders you created to assign to enterprise objects.

If your physical drawings were not completely customized – meaning that not all the physical object shapes had elements defined or selected – then when you try to generate an enterprise diagram you will get a message that, "Only fully customized physical layer-0 diagrams can be selected for enterprise layer-0 generation."

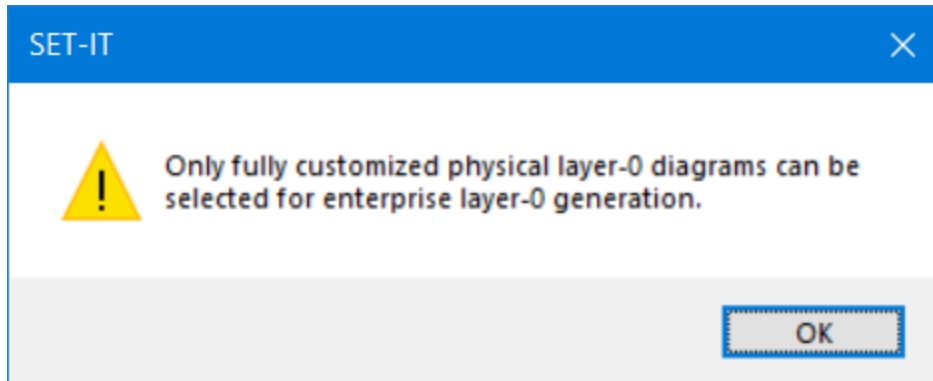

Go back to your physical diagrams and finish defining and selecting elements for all of the physical object shapes on the diagram.

Once your Enterprise diagram is generated you can finish customizing it by reviewing some of the mappings and ensure they reflect what you want. SET-IT will take a conservative approach and assign stakeholders to enterprise objects based on the assignments in the selected service packages as well as other ARC-IT service packages that have similar enterprises.

Shown below is an example of a Layer 0 drawing. This project had been imported from the V2I Safety Initiative project that is in RAD-IT's sample file. After import, a Physical layer 0 diagram was created then, after switching to Enterprise View, a new Enterprise layer 0 diagram was created and edited to move the shapes around for legibility purposes.

In this case multiple Physical diagrams were created based on subsets of the overall project then corresponding Enterprise diagrams were created to show the relationships between the stakeholders needed for those parts of the project.

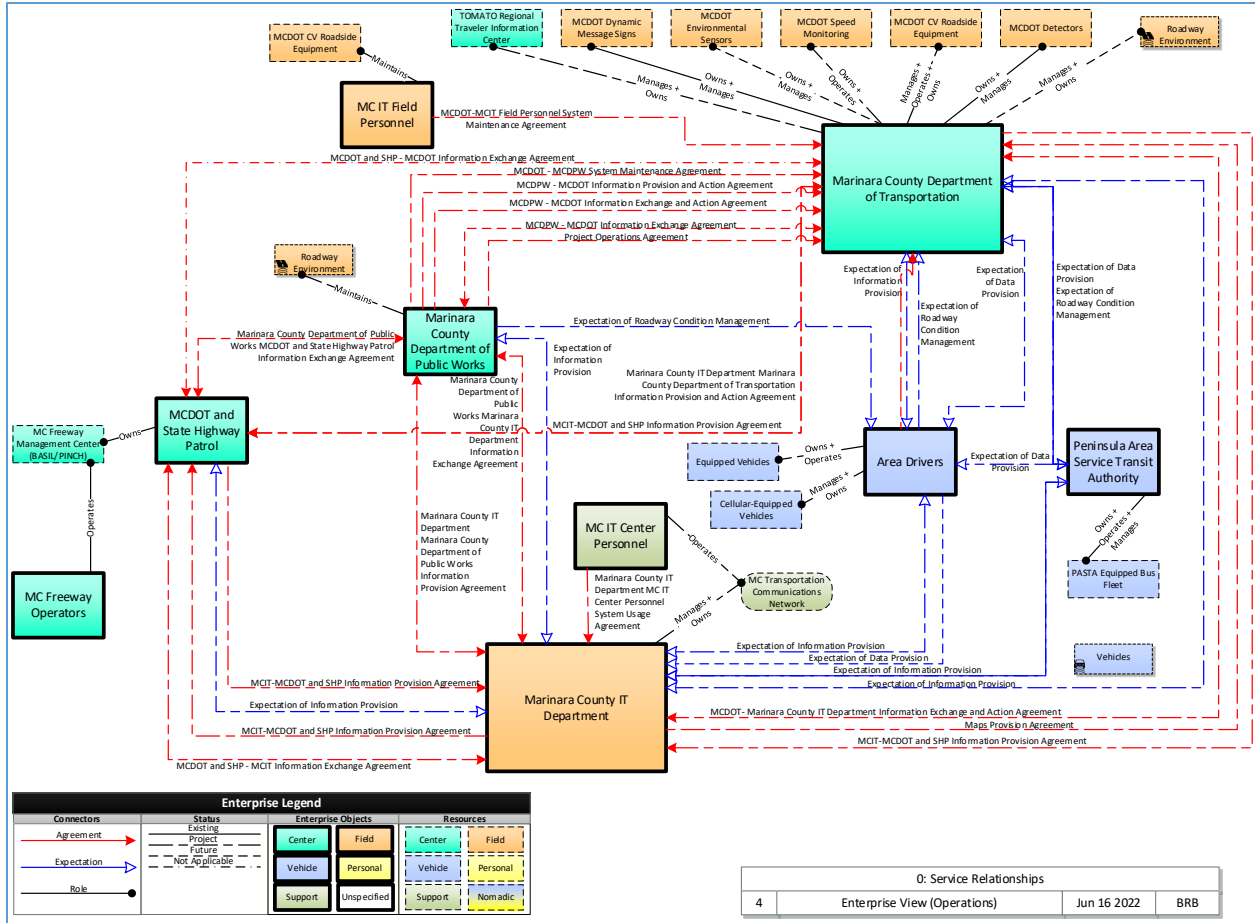

SET-IT will select relationships or points of coordination to include in the Coordinations Report or on a generated Enterprise Layer 0 drawing by looking at the service package as well as at other potential relationships that are defined between those same Enterprise Objects in other parts of ARC-IT.

SET-IT will automatically set the initial color of the enterprise objects based on the roles the stakeholders have with the physical elements. For instance, if a given stakeholder holds an 'owns' role with several field-based elements then it will color that stakeholder Orange to reflect that it is, primarily, a Field based owner. Some times the box will be white if it cannot determine which to use. You can use Shape Properties to set the color you prefer.

SET-IT and Agreements

Agreements are defined automatically as you customize your physical view diagrams based on the roles that stakeholders have with the elements and the interfaces between them. For example, if one stakeholder owns a traffic management center and another stakeholder owns a transit management center, and they are doing Transit Signal Priority with the traffic control priority flows going between the 2 centers then SET-IT will automatically generate an Information Exchange Agreement between those 2 stakeholders.

Another type of agreement automatically generated by SET-IT is an element-based agreement when the stakeholders' relationship with each other pertains more to an element or group of elements than to any interface between their elements. An example here might be a common element in which one stakeholder 'owns' the element and another stakeholder 'maintains' that element which might be common for some field deployments. In that case, SET-IT will automatically generate a System Maintenance Agreement between those 2 stakeholders. Another element based agreement comes into play with the ownership or other role is assigned to a group of stakeholders rather than an individual stakeholder. When a Stakeholder Group has a role with respect to an inventory element then SET-IT will automatically generate a joint agreement between those stakeholders, e.g., a "Joint Ownership Agreement". So a group with an 'owns' role to a TMC would spawn a Joint Ownership Agreement of the TMC, a 'maintains' role would spawn a Joint Maintenance Agreement, etc.

NOTE: This Joint type of agreement would not appear on an enterprise diagram since there is no 'line' to be drawn between stakeholders – there is just the one stakeholder and the role it has with the element or resource shape. You can use the Member Of lines to show the different stakeholders that make up the stakeholder group to show it graphically or use the Output Tables to list the element based agreements.

Add a Shape to a Diagram

In order to add a shape to an enterprise diagram, select a **Shape** from the stencil on the left. For enterprise diagrams these include Enterprise Objects of various classes, Resources of various classes, Agreements, Expectations, Roles, Comments, Notes, Legend, and an extra Title Block.

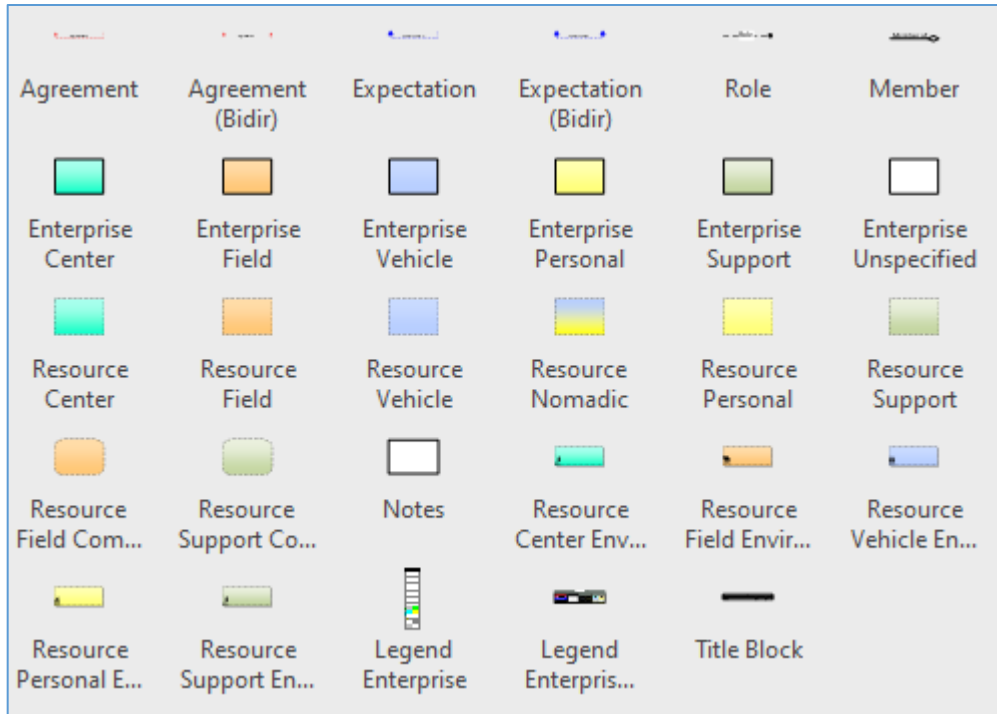

- Agreements are shown as a red line either one directional or bi-directional.
- Expectations are shown as a blue line either one directional or bi-directional.
- Role is a black line with a solid black circle on one end.
- Member (as in A is a member of Group X) is a black line with a white diamond on one end.
- The Enterprise Object boxes, which represent institutional Stakeholders in the architecture, are colored rectangles with a bold black line around them. See below for an explanation of the color coding.
- The Resource boxes, which represent the systems and devices of the system, are also colored rectangles. They have a faint line around them. There are some variations in the style or coloring of the Resource boxes:
 - System resources are shown as a colored rectangle with the same coloring scheme as the enterprise boxes.
 - A Nomadic resource can be used to show a device that is sometimes a personal device and sometimes part of a vehicle.
 - Communications resources have rounded corners.
 - Environmental resources have an icon in the lower right representing their class.
- Notes are shown as a blank white rectangle with a bold black line.
- The Enterprise Legend can be added with either a horizontal or vertical orientation.
- The Title block is a rectangle shape that can be placed on a diagram in case the automatically generated title has been removed for some reason.

To add a shape to an Enterprise diagram, click one of the shapes on the stencil and drag the **Shape** to the drawing area.

Double click on the Shape or right-click and select **Shape Properties** to view and edit the properties of that new shape.

The Enterprises and Resources are colored coded based on their class: center, field, personal, support, vehicle, or unspecified – used for functional objects or for when enterprises are repeated on the same diagram. There are additional shapes for Resources – the Resource Communications has the color of a resource class and the rounded corners of a communications element. There are also shapes for Environmental type resources (things the sensors sense) that are also color coded based on their class. Note there is no Communications Enterprise because the enterprises – companies, agencies, and staff – that run or own a communications domain system are the same enterprises that run other support systems.



NOTE: the Shape Properties box will be 'floating' to the left side of the window when it first opens. To re-dock it simply click the title of the box and drag it over and 'drop' it over the icon that looks like a closed door on either the left side or right side of the screen. You can 'undock' it by clicking the title of the box and dragging it to another area of your screen. You can also simply close the Shape Properties by clicking the X button in the top right of the window.

Delete a Shape

Select a **Shape** in the drawing area by clicking once on the shape.

Click **Delete** on the keyboard. It will ask if you are sure.

You can also right-click and select Delete.

If you delete a user-defined Resource you will be informed with a pop-up screen that a Physical Object by that name also exists and you will be asked if you want to delete that, too. Conversely, if you delete a user-defined Physical Object in Physical view, you will be informed that a Enterprise Object / Resource by that name also exists and asked if you want to delete that, too.

Create a Stakeholder

A "stakeholder" in SET-IT represents an instance of an enterprise object from ARC-IT. Think of this as the local or personalized version of what the national or reference framework has defined. A stakeholder defines an organization that owns, manages, or interacts in some way with the intelligent transportation or other system elements in a project. When multiple stakeholders are involved, there are relationships between them that appear on the Enterprise view of an architecture. Stakeholders can also be grouped together for joint or combined roles.

You can create your own stakeholder and associate them with one or more enterprise objects.

NOTE: while a stakeholder may be associated with more than one enterprise object, the shapes on any particular diagram only represent one enterprise object at a time.

There are several ways to create a stakeholder:

- From an enterprise diagram, double-click on one of the rectangles that represent an enterprise object. This will open the Shape Properties window. From there click the **New** button to open the Stakeholder Details window.
- From the 'New' area of menu bar on the "Home" ribbon, select Item / Stakeholder. This will also open the Stakeholder Details window.
- From anywhere in the Physical or Enterprise view press <Control-t> which is a shortcut key to open the Stakeholder Details window.

When starting with the Shape Properties window you will first select the appropriate **Status** from the pull-down menu located on the middle of the form.

Select from an existing stakeholder in the center of the screen. SET-IT will filter the selections based on the class or type of object – if you dragged a Field shape onto the diagram it will only show field elements.

If you don't see a stakeholder listed, click the **New** button in the shape properties form.

The **Stakeholder Details** form appears as shown below:

Stakeholder Details

Name: M The Group

Description: "M The Group" is a group of stakeholders that include the DOT and other stakeholders that are affiliated with the things that the M DOT own and/or operate.

Stakeholder Stakeholder Group

Group Member(s)

- DOT Traffic Ops Personnel
- Local EM Agencies
- Local Transit Agencies
- M DOT
- MandC Maintainers
- MandC. Mar

Element	Role	Status
m Asset Mgt Sys	Owns	Project
M Infra Mons	Owns	Project
M DMS	Uses	Future
*		

Form Source: New Stakeholder

Add an Enterprise / Stakeholder

Create a New Diagram or open an Existing Diagram.

Select one of the 6 different **Enterprise Objects** from the stencil on the left and drag it onto the drawing surface.

Enterprise Objects come in 'classes' based on how they are defined in ARC-IT. The Enterprise Object Classes are:

- Center
- Field
- Personal
- Support
- Vehicle
- Unspecified

NOTE: Unspecified is unique to Enterprise and represents Enterprise Objects that aren't necessarily tied to one class of physical objects, e.g., a Maint and Constr Vehicle Owner that may have responsibilities over both the vehicle-based maintenance and construction vehicles onboard equipment as well as the center-based dispatch and monitoring systems.

Drag the **Enterprise shape** to the diagram area and double-click on the **Enterprise shape** so that the **Shape properties** form appears on the screen.

Select a **Stakeholder** from the list in the middle of the form. If none are listed, you will need to click **New** to add a Stakeholder.

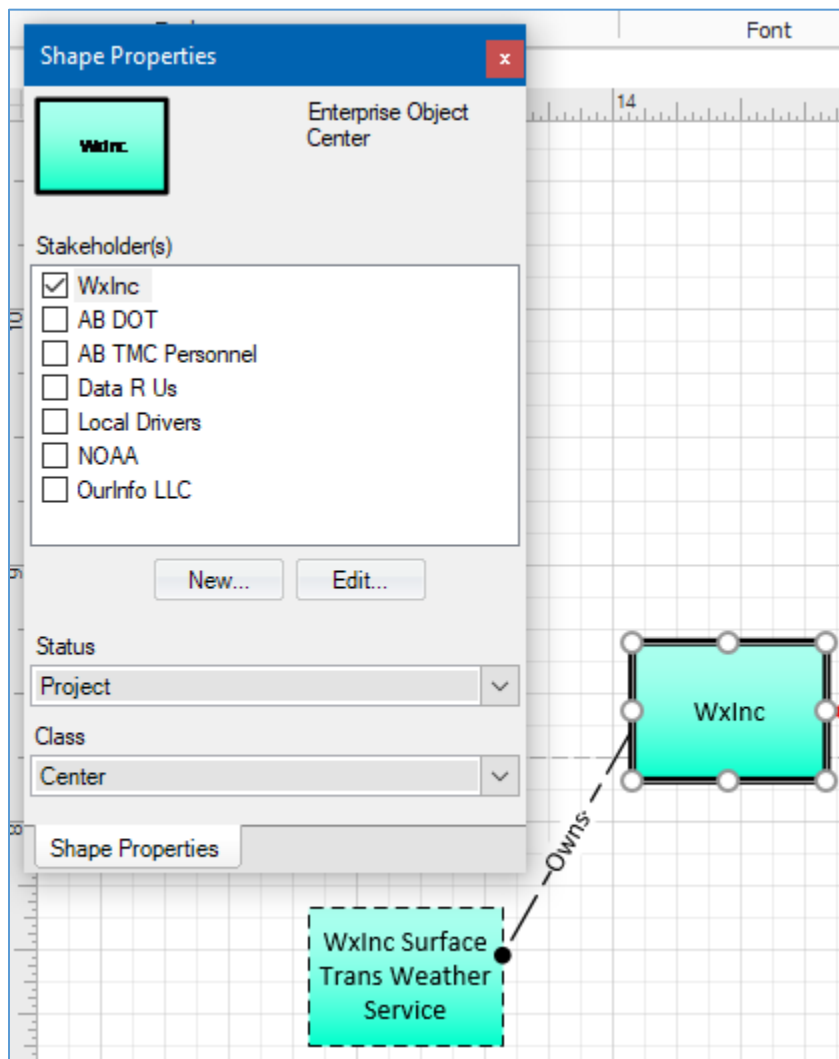

Select appropriate **Status** from the pull-down menu located on the middle of the Form,

The selected **Stakeholder** name will appear on the shape.

You can also select one of the classes and the color of the shape will change to match the class:

- Center – teal (light green)
- Field – orange
- Personal – yellow
- Support – darker green
- Vehicle – blue
- Unspecified – white

A word of warning on this ability to change the color of the enterprise object box. If this diagram has been automatically generated by SET-IT using the relationships the stakeholders have with the elements then the color will automatically be generated. This is usually accurate and you can leave it alone, e.g. the DOT is colored orange if the relationships are showing that it 'owns' several field elements. However, you may want to change this to reflect your own understanding of the project and show the DOT as teal.

Add a Resource

Resources are shown as boxes with dashed lines in the Enterprise view to indicate the things that are being managed, operated, etc. by the Enterprise Objects. In terms of an ITS project, think of a Resource as one of the Elements from the physical view just as the enterprise objects are related to the project's Stakeholders.

Resources, like Physical Objects, can be one of 6 classes:

- Center
- Field
- Personal
- Support
- Vehicle
- Nomadic (combination of Vehicle and Personal)

There are also shapes for Resources that are system elements, communications type elements, and environmental terminators.

To create a resource, drag a **Resource** shape from the Stencil onto the diagram.

Double click on the **Resource** and **Shape properties** form appears on the screen.

Select the appropriate **Resource** from the checkboxes located on the bottom of the **Shape Properties** Form. These choices are based on the ARC-IT resources that are from that class. They also include User-Defined Physical Objects that were created while in the Physical View

Select an **Element** from the list in the middle of the form. If none are listed you will need to click **New** to add an Element. You can skip this step, but the box will simply have the generic italicized name with braces around the name indicating that it needs to be customized.

Select appropriate **Status** from the pull-down menu located on the middle of the Form.

The selected **Resource** name will appear on the shape.

Remember Resources are linked to the Physical view so that as Resources are added or edited, they will be reflected in the Physical Objects or their customized Elements that are also in the Physical View.

Add a Hyperlink

Hyperlinks provide a way to automatically link terms or objects in your SET-IT project to another location or file, perhaps to another location on the internet. From the Information Flows, Physical Objects, Functional Objects, and Resources windows click on the Hyperlink button and you will see the following screen:

The first time you will need to Add a hyperlink by pressing the Add/Edit button at the top left of the Hyperlink screen:

	Hyperlink Name	Hyperlink Address	Hyperlink Description
🔗	New Standard Links	http://www.newtown.net/standards101	Describes New Standard Links for New Town ITS Projects
*			

In the 3 columns on the Hyperlinks details screen you can enter the following:

- Hyperlink Name - is the readable text you want your readers to see in the documentation, e.g., "Architecture Team Website."

- Hyperlink Address - is the fully qualified Uniformed Resource Locator (URL), e.g., "http://www.newtown.net/standards101".
- Hyperlink Description - is a place for you to provide any additional descriptive text explain what the link is used for or where it's located, e.g., "Describes New Standard Links for New Town ITS Projects".

Creating a New Agreement

Agreements are shown as red lines on the Enterprise diagrams with arrowheads on one or both ends. They connect Stakeholders, also known as Enterprise Objects, together by defining what has to be agreed upon in order for a service package to be implemented, operated, coordinated among agencies, maintained, etc.

To create an agreement, drag an **Agreement** line from the Stencil onto the diagram area. Connect it between Stakeholder or Enterprise Object shapes. SET-IT will prevent you from attempting to draw an agreement between an Enterprise and a Resource.

You can choose from a unidirectional or bidirectional agreement – indicated as "**(Bidir)**".

NOTE: Generally, agreements are bidirectional since both parties have to agree. Occasionally, there may be a situation where you want to indicate that one party is the lead and the other party is the recipient or dependent part of the agreement.

Double click on the **Agreement** line and the **Shape Properties** form appears on the screen.

Select the appropriate **ARC-IT Agreement** from the pull-down menu located on the bottom of the **Shape Properties** Form to choose the desired agreement type. The list of agreement types from ARC-IT are shown and you can also choose "<Unspecified>" if the agreement type you need isn't listed.

Select an **Agreement** from the list in the middle of the form. If none are listed you will need to click **New** to add an Agreement. You can skip this step, but the box will simply have the generic italicized name with braces around the name to indicate that it needs to be personalized.

Select appropriate **Status** from the pull-down menu located on the middle of the Form,

The selected **Stakeholder / Enterprise Object** name will appear on the shape.

If you need to create a **New** Agreement or if you choose to **Edit** one of the existing agreements in the Shape Properties list then the Agreements window appears with a box for Name, Description (that can be Auto-populated if an ARC-IT Agreement was selected on Shape Properties) and columns for Source, Destination, and Status. For Bidirectional agreements the ordering of source and destination really don't matter.

If you are creating a new agreement the Source and Destination will be prepopulated based on what was selected on the diagram. For agreements not already defined in ARC-IT the User Defined box will be checked.

S Agreements

Name: Our Town Employment Agreement

Number: T-00101C User Defined

Description: [Auto-Populate](#) City Form T-00101C - An agreement between the town's Traffic Division and its staff. Stipulates rules of behavior.

Agreement Type
Employment Agreement

Source	Destination	User Defined	Status	Bidirectional
▶ Our Town Traffic Division	Our Town Traffic Operation: ▼	<input checked="" type="checkbox"/>	Project	<input checked="" type="checkbox"/>
*		<input checked="" type="checkbox"/>		<input checked="" type="checkbox"/>

Form Source: New Agreement

OK Cancel

From this Agreements details form you can edit the name, select the *Type*, fill-in a *Description*, add a *Number*, adjust the *Status*, and assign *stakeholders* as either the source or destination. Use the Auto-Populate button to fill-in the Description field with the description of that type of agreement from ARC-IT.

NOTE: You will need to go back to Shape Properties on the diagram if you want to change the type of ARC-IT agreement that this custom agreement is based on.

Creating a New Expectation

Expectations are shown as blue lines on the Enterprise diagrams with empty arrowheads on one or both ends. They connect Stakeholders, also known as Enterprise Objects, together by defining what is expected from each other in order for a Service Package to be implemented.

To create an expectation, drag an **Expectation** line from the Stencil onto the diagram area. You can choose from a unidirectional or bidirectional agreement – indicated as "**(Bidir)**".

NOTE: Generally, expectations are unidirectional since one party may expect information or some action from another. Occasionally, there may be a situation where the expectation flows both ways between Stakeholders.

Double click on the **Expectation** line.

Shape Properties form appears on the screen.

Select the appropriate **Expectation** from the list in the middle of the form.

Select appropriate **Status** from the pull-down menu located on the middle of the Form,

The selected **Expectation** name will appear on the shape.

If you need to create a **New** Expectation or if you choose to **Edit** one of the existing expectations in the Shape Properties list then the Expectations window appears with a box for Name, Description and columns for Source, Destination, and Status. For Bidirectional expectations the ordering of source and destination really don't matter.

Creating a Role

Roles are shown as black lines with a black circle on one end. They are used to graphically depict how Stakeholders and their Resources are related.

To create a Role, drag a **Role** line from the Stencil onto the diagram area.

Double click on the **Role** line.

Shape Properties form appears on the screen.

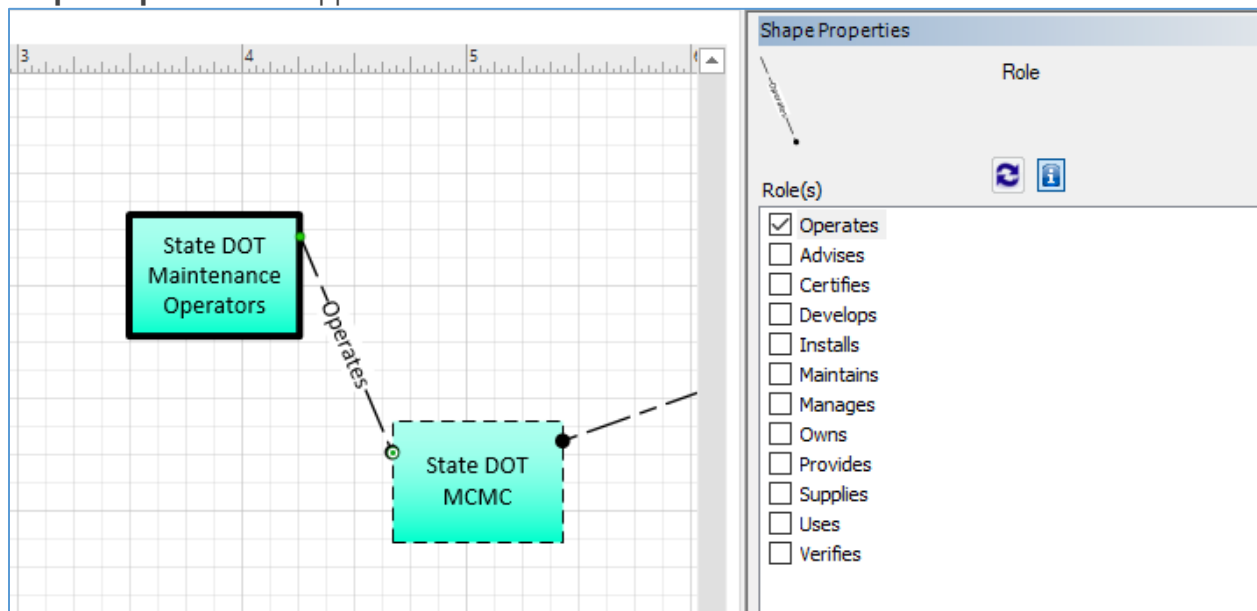

Select one or more of the available Roles defined in ARC-IT or click "New..." and define a user defined role. ARC-IT defines 12 potential roles as shown below:

Table 2. ARC-IT Enterprise View Roles

Name	Description
Advises	An Enterprise that can provide information about a Resource or Document.
Certifies	An Enterprise verifies that a target Resource meets relevant performance, functional, environmental, and quality requirements. This could be an independent third party or it could be the same entity that has the Develops role. For instance, an automotive OEM practicing "self-certification" would have this role with respect to the Basic Vehicle, whereas an independent certification body might have this role with respect to a Vehicle OBE (though of course the OEM could also fill this role).
Develops	An Enterprise creates the target Resource or Document. The Enterprise that engineers a traffic signal controller (ITS Roadway Equipment) or designs a vehicle (Basic Vehicle) or authors a technical standard will have the Develops role.
Installs	An Enterprise performs the initial delivery, integration, and configuration of the target Resource. This might be a system integrator, a state DOT Enterprise performing its own installation, or a device supplier that performs on-site installation.
Maintains	An Enterprise administers the hardware and software that comprise the target Resource. The entity that takes the 'maintains' role typically is delegated authority by the entity with the "Owns" or "Manages" roles, depending on the environment. The maintainer interacts with the target Resource so as to keep that Resource in the Operational state.
Manages	The Enterprise that is accountable for performing actions with a Resource, typically in support of one of the key operations-related roles (operates, installs, maintains). This authority is typically delegated by the Enterprise with the "Owns" role, and commonly accomplished by delegation to Human E-Objects with the "operates", "installs" or "maintains" roles, depending on the context.
Operates	A Human that is accountable for performing actions with a Resource, typically in support of one of the key operations-related roles (operates, installs, maintains). This is the person at the console or behind the wheel.

Name	Description
Owns	An Enterprise has financial ownership and control over the Resource. An Enterprise that Owns a resource is considered accountable for the resource and all of its contents. The Owns role includes ownership during Operations and Maintenance and also Acquisition during the Installation phase. The entity that takes the "owns" role is ultimately responsible for ensuring the resource provides its promised functionality, and for securing the data that the Resources holds and exchanges. The owner is similarly responsible for the facilities inherent to the resource that are used to exchange data with other systems. The owner is responsible for ensuring that any data stored by the resource and any data communicated by the resource are protected to the extent necessary considering the contents of the data and the consequences of its exposure or alteration.
Provides	The Enterprise that provides the basic service of a service package.
Supplies	The Enterprise that supplies (provides) a device or software product. The Supplier delivers the target resource to the Owner.
Uses	An Enterprise or Human that interacts with a Resource or Document in a way not captured by other roles. For instance, the person that reviews a document, or the agency informed of project status would have this role.
Verifies	The Enterprise that determines whether or not a target Resource meets documented requirements. This action is typically on behalf of the Owner.

Select appropriate **Status** from the pull-down menu located on the middle of the Form. The selected **Role** name(s) will appear on the shape.

When a Stakeholder is selected that has one of the roles listed above then behind the scenes they are mapped to an Enterprise Object that corresponds to that resource or physical object and their role. For instance, a Stakeholder that has been marked as 'Uses' an element that has been mapped to the Personal Information Device physical object will be assigned as a 'Personal Information Device User'. This is then used when the Enterprise diagrams and underlying relationships are drawn.

NOTE: You can change which roles are required by going to the Definitions grid and checking the Required checkbox. This will decide which roles appear on the Element Details form when you edit an element of the physical view and you want to establish the roles that various stakeholders play with respect to that element.

Drawing a Member of relationship

The Member line appears as a black line with an open or white diamond on one end. It is used to show the relationship that exists when one stakeholder is a member of a group of stakeholders. This is useful when it is the group of stakeholders that collectively own or manage a resource like a Joint Operations Center of some sort. When the enterprise diagram is drawn automatically it would show the enterprise that owns or manages that resource or element. In this group scenario it would show that the group is the enterprise owning or managing that resource. The 'Member' line can be used

to show the relationships then between stakeholders to it will be apparent to your readers and reviewers who it is that is part of that group.

To use the Member relationships, start by creating the stakeholders on the Stakeholders table on the Definitions menu. Also create the Stakeholder Group and indicating which stakeholders are members of that group.

Then, on the Diagram, place the appropriate enterprise object shapes on the diagram and use Shape Properties to assign the stakeholders to them. This may have already been done if the diagram was generated automatically from a fully customized Layer 0 physical diagram.

Next, drag out the Member line to the diagram. Connect the end without the diamond to the individual stakeholder and connect the diamond end to the stakeholder that is the Group.

NOTE: If you connect it the other way or just between 2 individual stakeholders then the diagram will erase the "Member of" label leaving you with a blank line. That's your clue that you have it backwards or not connected between a stakeholder and their group.

Notes about Drawing Enterprise Diagrams

When a project's stakeholders have been defined and their roles with respect to their elements defined it will be good to see a summary of the project that includes all of the stakeholders involved in the project. SET-IT's **Layer 0** enterprise diagram shows the project's stakeholders and their relationships. The Layer 0 drawing may be helpful to external stakeholders or decision makers to quickly see the scope of a project.

Typically, users will want to create a Layer 0 diagram in Physical View after they have completed their Physical View Layer 2 service package-level diagrams.

Can I Draw My Own Layer 0?

While you will usually create an enterprise diagram after creating the physical layer 0 but you can also start from scratch, that is, create your own layer 0 drawing. You can use the stencil to drag enterprise object shapes onto the diagram and assign them to ARC-IT enterprise objects (and stakeholders).

Enterprise Diagram Complexity

CAUTION: Lastly, as the number of service packages (Layer 2s in physical) in your project grows so will the size and complexity of your Layer 0 drawings (both physical and enterprise). SET-IT will attempt to place objects in a logical place and route the relationships as best it can but you will need to edit these yourself.

Communications View

This section describes how to create and modify your architecture's communications view, including how to edit the Communications solutions used in your project.

The Communications View identifies the protocol stacks needed to implement an information flow between a source and destination (e.g., information flow triple) in the Physical View. ARC-IT terms these protocol stacks as "solutions". Solutions are composed of a collection of industry standards; usually formally developed standards produced by a standards development organization, but often a published specification such as an IETF RFC. Each triple from the Physical View is associated with one or more solutions.

The ARC-IT Communications Model is based on previous work in the communications arena. Major sources include the Open System Interconnection (OSI) Model, the ITS Station architecture (from ISO 21217), the NTCIP Framework, and the Internet Protocol Suite.

Much like some of these other models, the ARC-IT Communications Model groups OSI model layers together. This is done because certain protocols are nearly always deployed with certain pairings. For example, the Transmission Control Protocol (TCP) is seldom implemented without Internet Protocol (IP) at the next lowest layer. This is good: it means we can logically group some of these layers together to reflect what is implemented rather than looking at a logical assemblage of individual layers. It keeps the model a little simpler than in previous iterations, which should make it easier to use.

- **ITS Application Entity:** ITS Application Entity standards specify the structure, meaning, and exchange patterns of information between two end points. Referred to as 'ITS Application Specifications' in some contexts.
- **Facilities Layer:** Facilities Layer Protocols define the rules and procedures for exchanging data, for representing the bits and bytes of information content to be transferred (e.g., encoding), and provide mechanisms for opening, closing, and managing a dialogue between ITS Applications. Sessions may be asynchronous as in paired requests and responses (information exchanges), asynchronous as in an unsolicited publication of information, and may require acknowledgement of receipt or not.
- **TransNet Layer:** TransNet layer protocols define the rules and procedures for exchanging application data between endpoints as well as the routing, message disassembly/re-assembly and network management functions.
- **Access Layer:** Access Layer protocols define the rules and procedures for exchanging data between two adjacent devices over some communications media, as well as the signaling protocols that are typically developed for specific communications media.
- **Management:** Management standards define the rules and procedures for controlling elements at all layers.
- **Security:** Security standards define the rules and procedures for providing cybersecurity at all layers.

A typical triple solution is assembled according to the ARC-IT communications model, as defined by the [communications viewpoint](#). All solutions are built according to this model, and the components of the solution assigned to the various parts of the model depending on their role in the solution.

Sometimes a standard satisfies multiple aspects of a solution, and so might appear more than once in an illustration of the solution. Triple solutions are accessible from several places, but are most commonly from the context of a [service package](#) by clicking on the flow or from the overall list of ARC-IT [triples](#).

ITS Info ITE TMDD Vol 2 ⓘ			Click gap icons for more info. 
Mgmt Bundle: SNMPv3 MIB ⓘ W3C WSDL 1.1 ⓘ	Facility ITE TMDD Vol 2 ⓘ NTCIP 2306 ⓘ TransNet Bundle: TCP/IP ⓘ SubNet Internet Subnet Alternatives ⓘ	Security Gap ⓘ IETF RFC 8446 ⓘ	

ITS Application Entity ITE TMDD Vol 2 ⓘ			Click gap icons for more info. Security Gap  Name: Uncertainty about trust revocation mechanism Gap Notes: The mechanism by which trust is revoked from misbehaving actors in IEEE 1609.2 has not been proven. Type: Security Gap Severity: Medium Description: The mechanisms used to prevent bad actors from sending authorized messages is unproven.
Mgmt Bundle: SNMPv3 MIB ⓘ W3C WSDL 1.1 ⓘ	Facilities ITE TMDD Vol 2 ⓘ NTCIP 2306 ⓘ TransNet IETF RFC 793 ⓘ IP Alternatives ⓘ Access Internet Subnet Alternatives ⓘ	Security Secure Session Alternatives ⓘ Gap ⓘ Gap ⓘ Gap ⓘ GAP ⓘ GAP ⓘ	

Note that some layers might have alternatives, in which case all of the gap icons associated with every alternative may be shown on the diagram, but the solution severity calculations (and resulting ordering of solutions) includes only the issues associated with the default (i.e., best, least severe) alternative.

A sample triple solution diagram from the ARC-IT website is shown above. In ARC-IT, standards names are sometimes underlined indicating the standard is actually part of a group of standards or one of several alternatives; clicking on the link will expand the bundle or explain the alternatives. 'Info' buttons next to standards generate pop-ups that provide some detail about the standard in question.

There are also several 'gap' icons that reflect *issues* with the use of standards in that particular area of the model. Issues come in two types: gaps, which are issues where some requirement of the triple is not met by the standard or collection of standards in the solution, or overlaps, which are issues where multiple standards exist to serve the solution, and it is not obvious which one to choose. Issues are assigned severity levels to indicate the degree to which the issue impacts the operation of the solution in practice. On the example above there is a moderate-level security gap and a minor gap at the ITS Application Entity. Note that some layers might have alternatives, in which case when the Communications Solutions calculations are run in SET-IT the solution severity calculations will also run and select as default the solution with the best, least severe alternative.

The Communications View does not show standards that pertain only to the physical or functional objects like the Advance Traffic Controller cabinet standard nor will it show physical security standards. Physical and Physical Security type standards are defined and shown in the Physical View.

The components of the Communications view include:

- Definitions – menu of tables to view, tailor, and add to the following:
 - Flow Triples to Solutions
 - Solutions
 - Issues
 - Profiles
 - Physical Interconnects
 - Standards
 - Standard Bundles
 - Assumptions and Constraints (shared with Physical view)

SET-IT can generate diagrams like those shown on the ARC-IT website as an output once you are comfortable with the solutions assigned.

Populating the Communications View

Calculate Solution Assignments

As flows are defined in the Physical view – or, more accurately, when Elements are defined for the sources and destinations – then communications solutions are identified for the Communications View.

A communications solution consists of a data profile and a communications profile. As each flow is added to the architecture the likely solutions are selected. This is based on the ARC-IT Communications View which includes an assessment of gaps and issues with the communications and data standards in order to determine the readiest for deployment which is the solution with the lower 'score' when adding up all the issues. In most cases there is just one likely solution but there

are exceptions where more than one solution may be appropriate depending on the needs of the deployment, usage of data distribution, or issues/gaps that may exist for certain solutions.

The rules to select the solutions are run whenever you enter the Communications view if new information flows have been defined in the physical view.

The rules can also be run manually by clicking the “Calculate Solution Assignments” button at the top of the menubar.

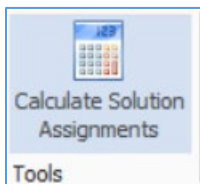

If Physical Objects are created or new user defined information flows are created SET-IT has rules built in to determine what solution is the best or most appropriate solution based on the source and destination physical objects. The rules also use the characteristics like confidentiality, availability, and whether a data distribution system is used to determine which is the most appropriate solution.

Not every flow in the physical view will show up in communications view – only the flows for which data and communications profiles have been developed. If you create user defined flows in physical, either from the new item menu or by changing characteristics of an ARC-IT flow. Other higher-level flows like “data publication” won’t be reflected in Comm View, either because in a deployed projects those type of flows are implemented using the exchange actual information flows between elements that support one of the services.

What does “(None-Data)” mean? You may see (None-Data) for the Data Profile when an information flow has no ITS Application Entity layer standards defined yet. You can find more information when you view the Solution Details and click on Issues. You will see an issue called, “Data Profile not Defined” with text that says, “Performance, functionality, and the upper-layers of the OSI stack have not been defined for this information flow.”

Communications Using Data Distribution

The solution calculation algorithm is designed so that:

- If the triple is Eligible to use a DDS, then only DDS solutions will be chosen.
- If the triple is Not Eligible to use a DDS, then only non-hub DDS solutions such as the Object Management Group Data Distribution Service (OMG DDS) may be chosen.

When you create your own user defined solution you can select whether your solution is intended to be applied to interfaces where a DDS is acting as an intermediary, places where it isn’t, or any type of interface.

Create a New or User Defined Communications Solution

Sometimes SET-IT may not have the Communications Solution you need. The database that comes with SET-IT contains 223 communications solutions based on the communications view from ARC-IT.

But as ITS and connected vehicle technology keeps evolving new projects are bound to have interfaces that are new and unique. Creating a new or User Defined Solution in SET-IT is not 'easy' but doable. Care should be taken and you should generally take advantage of the defined solutions developed by the ARC-IT program.

There are a couple of ways to create a new solution:

- From the New Items menu
- From the Solution Details form when you edit (changing any of the standards assignments or other aspects of an ARC-IT Solution)

Creating a Solution from the New Item Menu

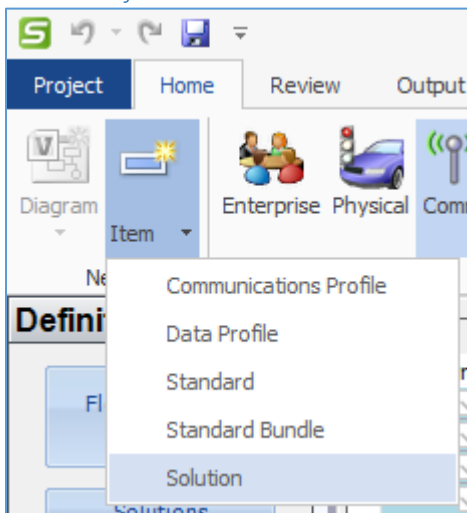

At the top left of the SET-IT screen click the Item pulldown from the New area and select the Solution. The Solution Details window opens.

Give it a Name, Select a Data Profile and a Comm Profile. Fill in a Description and tick-off which regions this solution should apply to. Use the Comm Class pull-down to select the class of communications that this solution applies to. This could be one of the following:

- Campus Area Network
- Local Area Network
- Metropolitan Area Network
- Other
- Personal Area Network
- Wide Area Network

The Standards assignments are pre-set by the Data/Comm Profile settings. If you make a change to one of the standards on any of the Layers then you will be prompted to create a user defined profile. The Issues tab will also be pre-populated based on the Data/Comm Profile standards assigned.

The Information Flow Triples tab allows you to select the information flows that can use this new solution. You will see a Physical Objects and an Elements button. Start with the Physical Objects button to select the Source, Destination, and Information Flow.

Solution Details

Name: User Defined

Data Profile: Comm Profile:

Description:

Region: AU EU US CA

Comm Class: Applied to:

Standards | Issues | **Information Flow Triples**

Elements Physical Objects

Source	Destination	Information Flow
▶ Vehicle OBE	Transportation Information Center	vehicle situation data
Traffic Management Center	Transportation Information Center	road network conditions
* <input type="text"/>	<input type="text"/>	<input type="text"/>

Form Source: New Solution

Then, if your project contains elements assigned to those physical objects and have the same flows that are selected on the PObjects tab then you will see those element flow triples for your new solution.

S Solution Details

Name: User Defined

Data Profile: Comm Profile:

Description:

Region: AU EU US CA

Comm Class: Applied to:

Standards | Issues | Information Flow Triples

Elements Physical Objects

Source	Destination	Information Flow
MC Freeway Management Center	TOMATO	road network conditions

The pull-down selections in the Information Flow Triples form are designed to only show what makes sense. The first column you choose will show you everything from ARC-IT – either all the physical objects from ARC-IT for the Source or Destination or all the ARC-IT information flows if you start with the Information Flow column. As you select one column the choices in the other columns will be reduced to the valid choices from ARC-IT. Then as you make your 2nd choice the 3rd column will be reduced even further.

Comm Class:

Standards | Issues | Information Flow Triples

Elements Physical Objects

Source	Destination	Information Flow
Transit Management Center	Transit Vehicle OBE	<ul style="list-style-type: none"> alarm acknowledge authorization response connection protection instructions fare management information remote vehicle disable transfer status transit schedule information transit stop locations transit stop request transit traveler information transit vehicle operator authentication update transit vehicle operator information

NOTE: if a flow alias has been applied then the alias will appear in this list followed by the original flow name in parentheses.

Using the Communications View Definitions Menu

The Definitions menu includes tables to view, tailor, and add to the following:

- Flow Triples to Solutions
- Solutions
- Issues
- Profiles
- Physical Interconnects
- Standards
- Standard Bundles
- Assumptions and Constraints (shared with Physical view)

See below for more information about each of the communications view grids.

Flow Triples to Solutions Grid

This lists the Information Flow Triples (source element, destination element, and flow name) from the physical view and the assignment to a solution. It also lists the Solution Issue Score associated with the solution which is the numerical sum of the gaps/issues associated with each of the layers in the data/communications profiles. There is an indication if a Communications Element was used as a means to route the flow of information from the Source to the Destination. There is also an indication if a Data Distribution System was used. An Override flag indicates if a solution other than the default recommended by SET-IT has been selected. A Details button can be clicked to see more information and to see the full list of issues associated with the selected solution.

Flow: [current infrastructure restrictions](#)

Source: [MCDPW GARLIC Information System](#) Destination: [Digital Map System](#)

Solution: [US: WZDx - Secure Internet \(ITS\)](#)

Solution Readiness: **Moderate** Summary Issue Score: **10**

Associated Issues:

Ignore	Severity	Issue	Description
<input type="checkbox"/>	Medium	Overlap of standards	Multiple standards have been developed to address this information and it is unclear which standard should be used to address this specific information flow.
<input type="checkbox"/>	Medium	Performance not fully defined (medium)	The performance rules are not fully defined for this information flow.
<input type="checkbox"/>	Medium	Secure data access not provided	The solution does not define rules on how the application entity authenticates requests to accept or provide data.
<input type="checkbox"/>	Low	Not a standard (minor)	The document is publicly available and widely used but it is not currently a formal standard.

Form Source: Grid - Flow Triples to Solutions

When you change the solution, it may change the readiness of that solution if there are a different set of issues associated with that solution. When you change the Solution selected on the Flow Triple Solutions Issues screen it will change the score and the list of issues, and Override will appear on the screen next to the selected solution to indicate that a change was made. See the example below:

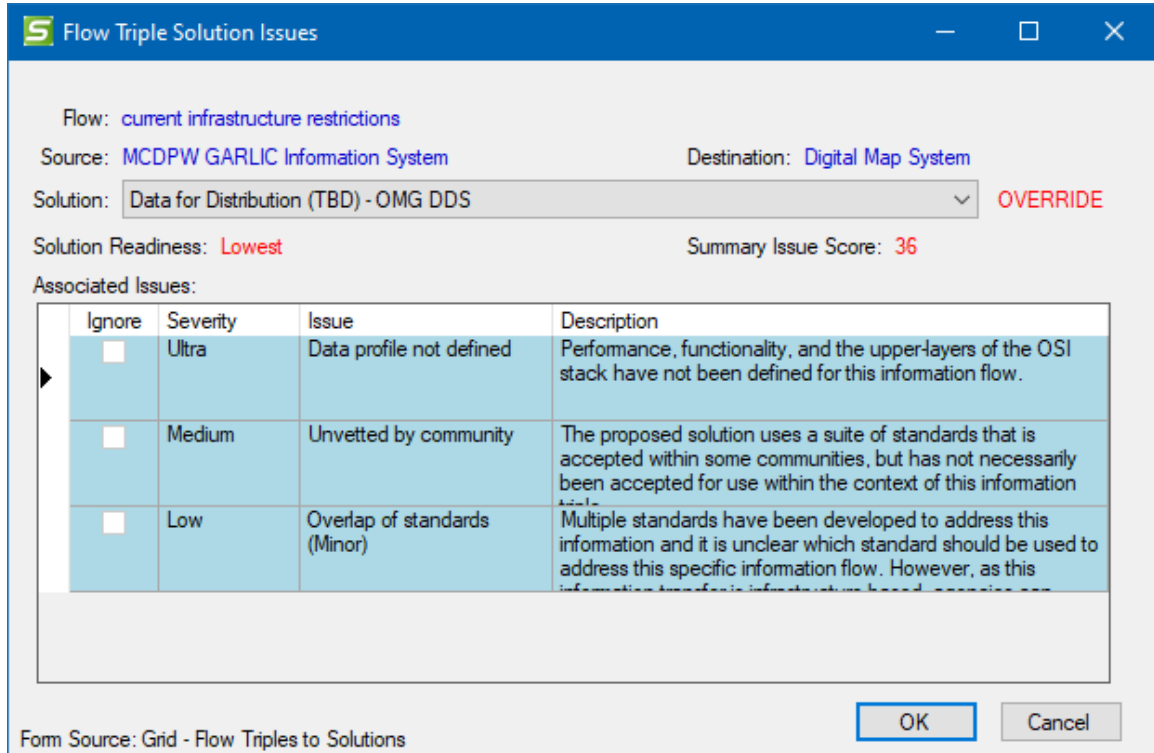

See [Issues](#) below for more information on how Issues are derived and scored in SET-IT. As part of the [Issues](#) discussion in [Using the Communications View Definitions Menu](#), as issues are added they are combined in to a Readiness or Suitability level in terms of its readiness or suitability for deployment.

Solutions

The Solutions grid is shown below. The Solutions grid shows the collection of communications protocols and data definitions that can be used to implement a given [triple](#).

In My Project	Name /	Description	Issue Score	Comm Class	Comm Profile	Data Profile	User Defined	More...
<input checked="" type="checkbox"/>	(None-Data) - Secure Internet (ITS)	this solution is used	32	WAN	I-I: Secure Internet (ITS)	(None-Data)	<input type="checkbox"/>	Details
<input checked="" type="checkbox"/>	(None-Data) - Secure Wireless Internet	this solution is used	32	WAN	I-M: Secure Wireless	(None-Data)	<input type="checkbox"/>	Details
<input checked="" type="checkbox"/>	(None-Data) - WAVE WSMP	this solution is used	38	LAN	V-X: WAVE WSMP	(None-Data)	<input type="checkbox"/>	Details
<input checked="" type="checkbox"/>	(None-Data) - Wide Area Broadcast	this solution is used	33	WAN	C-X: Wide Area Broadcast	(None-Data)	<input type="checkbox"/>	Details
<input checked="" type="checkbox"/>	(None-Data) - Apache Kafka	this solution is used	36	WAN	Apache Kafka	(None-Data)	<input type="checkbox"/>	Details
<input checked="" type="checkbox"/>	Data for Distribution (TBD) - Apache	this solution is used	36	WAN	Apache Kafka	Data for Distribution (TBD)	<input type="checkbox"/>	Details
<input checked="" type="checkbox"/>	Equipment Maintenance Data Sharing	Marinara County	4	WAN	Apache Kafka	Equipment Status Sharing	<input checked="" type="checkbox"/>	Details
<input checked="" type="checkbox"/>	GNSS Data - GNSS serial interface	this solution is used	6	Other	GNSS serial interface	GNSS Data	<input type="checkbox"/>	Details
<input checked="" type="checkbox"/>	TPEG2 - Wide Area Broadcast	this solution is used	4	WAN	C-X: Wide Area Broadcast	TPEG2	<input type="checkbox"/>	Details
<input checked="" type="checkbox"/>	TUF - Guaranteed Secure Internet	this solution is used	4	WAN	I-I: Guaranteed Secure	TUF	<input type="checkbox"/>	Details
<input checked="" type="checkbox"/>	TUF - Secure Internet (ITS)	this solution is used	4	WAN	I-I: Secure Internet (ITS)	TUF	<input type="checkbox"/>	Details
<input checked="" type="checkbox"/>	US: Device enrollment - Secure	this solution is used	3	WAN	I-I: Secure Internet (ITS)	US: Device enrollment	<input type="checkbox"/>	Details
<input checked="" type="checkbox"/>	US: Misbehavior reporting - Secure	this solution is used	6	WAN	I-I: Secure Internet (ITS)	US: Misbehavior reporting	<input type="checkbox"/>	Details
<input checked="" type="checkbox"/>	US: NTCIP Environmental Sensors -	this solution is used	5	MAN	I-F: SNMPv3/TLS	US: NTCIP Environmental	<input type="checkbox"/>	Details

The first column indicates whether the solution is “In” your project and the last column shows whether it is User Defined. The name of the solution is often made to first indicate the source region then combines the data profile and communications profile names. The grid then lists the description of the solution, the sum of the issue scores (higher scores mean the solutions has more and/or more severe issues), the communications class, e.g., Wide Area Networks (WAN), Local Area Networks (LAN), etc. The Communications Profile and Data Profile are listed, and a Details button brings up the Solutions Details form.

Solution Details

Name: User Defined

Data Profile: Comm Profile:

Description:

Region: AU EU US CA

Comm Class: Applied to:

Standards		Issues		Information Flow Triples	
ITS Information	Management	Security	Facilities	Transport/Networking	Access
<input checked="" type="checkbox"/>	NTCIP Message Sign Objects	<input type="checkbox"/>	CEN 15531-5 PublicTrans - SIRI Situation Xchange	<input type="checkbox"/>	
<input type="checkbox"/>	(None)	<input type="checkbox"/>	CEN 15722 ESafety - ECall - Minimum Data Set	<input type="checkbox"/>	
<input type="checkbox"/>	Addressed Elsewhere in Stack	<input type="checkbox"/>	CEN 16102 eCall - Op Reqs for 3rd party Support	<input type="checkbox"/>	
<input type="checkbox"/>	Application Specific	<input type="checkbox"/>	CEN 16157-1 DATEX for TM&I - Context & Fmwk	<input type="checkbox"/>	
<input type="checkbox"/>	ASTM Archiving Traffic Data	<input type="checkbox"/>	CEN 16157-2 DATEX for TM&I - Location Referencing	<input type="checkbox"/>	
<input type="checkbox"/>	ASTM Metadata to support ADMS	<input type="checkbox"/>	CEN 16157-3 DATEX for TM&I - Situation Publication	<input type="checkbox"/>	
<input type="checkbox"/>	Bundle: ADMS	<input type="checkbox"/>	CEN 16157-4 DATEX for TM&I - VMS Publications	<input type="checkbox"/>	
<input type="checkbox"/>	Bundle: DATEX	<input type="checkbox"/>	CEN 16157-5 DATEX for TM&I - M/E Data Publications	<input type="checkbox"/>	
<input type="checkbox"/>	Bundle: IEEE 1512	<input type="checkbox"/>	CEN 16157-6 DATEX for TM&I - Parking Publications	<input type="checkbox"/>	
<input type="checkbox"/>	Bundle: ISO Probe Data	<input type="checkbox"/>	CEN 16614-2 PublicTrans - NeTEx - Timetables Xchange	<input type="checkbox"/>	
<input type="checkbox"/>	CEN 12896-1: Transmodel Common Concepts	<input type="checkbox"/>	CEN 16614-3 PublicTrans - NeTEx - Fares Xchange	<input type="checkbox"/>	
<input type="checkbox"/>	CEN 12896-2: Transmodel Public Transport Network	<input type="checkbox"/>	CEN 17380 Controlled Zone Management	<input type="checkbox"/>	
<input type="checkbox"/>	CEN 12896-3: Transmodel Timing Information	<input type="checkbox"/>	DDS-Xtypes	<input type="checkbox"/>	
<input type="checkbox"/>	CEN 12896-4: Transmodel Operations monitoring and control	<input type="checkbox"/>	Development needed	<input type="checkbox"/>	
<input type="checkbox"/>	CEN 12896-5: Transmodel Fare Management	<input type="checkbox"/>	DMS and RWIS (AU)	<input type="checkbox"/>	
<input type="checkbox"/>	CEN 12896-6: Transmodel Passenger Information	<input type="checkbox"/>	ETSI 101 556-1 App: EV Charging Spot	<input type="checkbox"/>	
<input type="checkbox"/>	CEN 15213-4 After-theft systems - long range comms	<input type="checkbox"/>	ETSI 101 556-3 App: EV Energy Reservation	<input type="checkbox"/>	
<input type="checkbox"/>	CEN 15531-3 PublicTrans - SIRI Functional interfaces	<input type="checkbox"/>	ETSI 102 638 ITS BSA	<input type="checkbox"/>	

Form Source: Grid - Solutions

OK Cancel

The Details form shows the information from the grid and then a set of tabs is used to provide additional details. The Standards tabs are used to show the standards associated with each layer.

The Issues tab lists the issues associated with the standards in this solution.

Solution Details

Name: User Defined

Data Profile: Comm Profile:

Description: This solution is used within the U.S.. It combines standards associated with US: NTCIP Message Sign with those for I-F: SNMPv3/TLS. The US: NTCIP Message Sign standards include upper-layer standards required to implement center-to-field message sign communications. The I-F: SNMPv3/TLS standards include lower-layer standards that

Region: AU EU US CA

Comm Class: Applied to:

Ignore	Issue	Severity	Source	Description
<input type="checkbox"/>	Update data to SNMPv3	Low	Solution	Data has been defined for SNMPv1, but needs to be updated to SNMPv3 format.
<input type="checkbox"/>	Use TLS for SNMP Option	Low	Profile: I-F: SNMPv3/TLS	The standard allows for multiple security mechanisms. The only defined mechanism that meets the requirements for C-ITS is the one based on TLS.
<input type="checkbox"/>	Out of date (medium)	Medium	Standard: IETF RFC 6353 TLS for SNMP	The standard includes normative references to other standards that have been subject to significant changes that can impact interoperability, security, of systems and the

Form Source: Grid - Solutions

For user defined Solutions you will see a blank line allowing you to add Issues to this communications solution.

The Information Flow Triples tab lists the information flows mapped to this solution. Radio buttons let you choose to see it by Elements in your project or by ARC-IT physical objects.

Source	Destination	Information Flow
MC Freeway Management Center	MCDOT Dynamic Message Signs	roadway dynamic signage data
MCDOT Dynamic Message Signs	MC Freeway Management Center (BA	roadway dynamic signage status
MCDOT Dynamic Message Signs	MCDOT CV Roadside Equipment	roadway dynamic signage status
MCDOT Dynamic Message Signs	MCDOT CV Roadside Equipment	vehicle signage local data
MCDOT CV Roadside Equipment	MCDOT Dynamic Message Signs	roadway dynamic signage data

Standards		Issues	Information Flow Triples
		<input type="radio"/> Elements <input checked="" type="radio"/> Physical Objects	
Source	Destination	Information Flow	
Traffic Management Center	ITS Roadway Equipment	roadway dynamic signage data	
Traffic Management Center	ITS Roadway Equipment	lane management control	
Traffic Management Center	ITS Roadway Equipment	variable speed limit control	
Maint and Constr Management Cente	ITS Roadway Equipment	roadway dynamic signage data	
ITS Roadway Equipment	Traffic Management Center	roadway dynamic signage status	
ITS Roadway Equipment	Traffic Management Center	variable speed limit status	
ITS Roadway Equipment	Maint and Constr Management Cente	roadway dynamic signage status	

Issues

The Issues grid shows the gaps or issues with the use of standards in the selected interfaces. Issues come in two types: Gaps, which are issues where some requirement of the triple is not met by the standard or collection of standards in the solution, or Overlaps, which are issues where multiple standards exist to serve the solution. This grid shows the severity of the solution from Exemplary, None, Low, Medium, High, or Ultra for “ultra-serious” issues.

In My Project <input checked="" type="checkbox"/>		Ignore <input type="checkbox"/>	Severity	Name /	Type	Description	User Defined	More...
<input checked="" type="checkbox"/>	<input type="checkbox"/>	Low	Accuracy of data	ITS Info Gap	The standard is missing accuracy	<input type="checkbox"/>	<input type="checkbox"/>	Details
<input checked="" type="checkbox"/>	<input type="checkbox"/>	High	Application specification not defined	ITS Info Gap	The logic, performance, and application	<input type="checkbox"/>	<input type="checkbox"/>	Details
<input checked="" type="checkbox"/>	<input type="checkbox"/>	Low	Data may not be fully defined (low)	ITS Info Gap	The information flow is unclear as to what	<input type="checkbox"/>	<input type="checkbox"/>	Details
<input checked="" type="checkbox"/>	<input type="checkbox"/>	High	Data not defined (high)	ITS Info Gap	Required data elements are not defined.	<input type="checkbox"/>	<input type="checkbox"/>	Details
<input checked="" type="checkbox"/>	<input type="checkbox"/>	Low	Data not defined in standard format	ITS Info Gap	The definition of data concepts should	<input type="checkbox"/>	<input type="checkbox"/>	Details
<input checked="" type="checkbox"/>	<input type="checkbox"/>	Medium	Data not fully defined (medium)	ITS Info Gap	Some of the data elements for this	<input type="checkbox"/>	<input type="checkbox"/>	Details
<input checked="" type="checkbox"/>	<input type="checkbox"/>	Ultra	Data profile not defined	Data Profile Gap	Performance, functionality, and the	<input type="checkbox"/>	<input type="checkbox"/>	Details
<input checked="" type="checkbox"/>	<input type="checkbox"/>	Medium	Dialogs are not fully defined (medium)	Facility Layer Gap	The specific dialogs for exchanging this data	<input type="checkbox"/>	<input type="checkbox"/>	Details
<input checked="" type="checkbox"/>	<input type="checkbox"/>	High	Dialogs not defined (high)	Facility Layer Gap	Dialogs are not defined for this information	<input type="checkbox"/>	<input type="checkbox"/>	Details
<input checked="" type="checkbox"/>	<input type="checkbox"/>	High	Draft not available (Critical)	Standardization Gap	The standards development organization has	<input type="checkbox"/>	<input type="checkbox"/>	Details
<input checked="" type="checkbox"/>	<input type="checkbox"/>	Low	Guidance document under development	Standardization Gap	This recommended practice on how to use	<input type="checkbox"/>	<input type="checkbox"/>	Details

You can use the filters to change how the information is sorted and displayed. For instance, you can use the In My Project filter to show the other Issues from the communications view of ARC-IT that have not been assigned to any of the standards in your project. The Issues tab on the Communications Solution and Profile details screen shows which issues are mapped to each solution or profile. Issues can also be assigned at the Standard level.

Communications Solutions use the Issues and Gaps to determine which solutions are most appropriate and ‘ready’ for deployment. Now users can customize those calculations by clicking ‘Ignore’ to an issue if they know it will not affect their deployment. The readiness will then be recalculated for the information flow and the service packages that use it.

There is also the option to ‘Ignore’ the assignment of an issue at the Triple Solution level so that an individual information flow triple may ignore an issue while other similar information flows that have the same communication solution and the same issues may not ignore that issue. You will see the Ignore flag on several screens throughout the Communications view.

Can I create my own issue? Not directly, however, you can edit an existing issue and it will ask if you want to create a User Defined version.

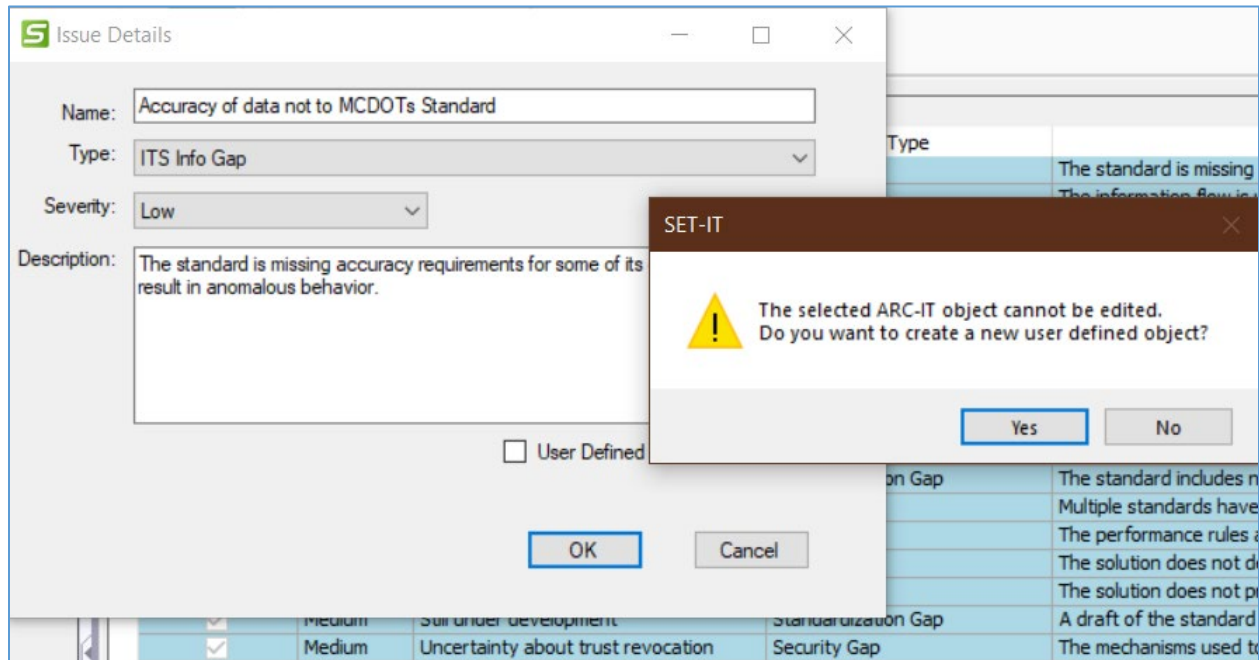

Click Yes and you will be able to assign your user defined Issue to your user defined communications Solutions.

The Issues are scored based on their severity and then all the issues are added together for a solution in order to determine the solution that is more viable given the relative number and severity of the issues. The table below shows what the terms in the Issue Scoring mean in terms of their suitability or readiness for deployment:

Table 3. Communications View Solution Readiness

Readiness Name	Scoring Values	Readiness or Suitability Description
Highest	0	Suitable for wide-scale deployment when applied to the triples it supports.
High	1-2	A small number of minor issues. For existing deployments, consider addressing issues as needed as part of maintenance or upgrade activities. For new deployments, the solution is likely suitable for wide-scale deployment when applied to the triples it supports, though the noted issues exist which should be considered and a path to addressing them developed, if needed, either as part of design or subsequent maintenance or upgrade activities.

Readiness Name	Scoring Values	Readiness or Suitability Description
High-Moderate	3-8	One significant or possibly a couple minor issues. For existing deployments, the chosen solution likely has identified security or management issues not addressed by the communications solution. Deployers should consider additional security measures, such as communications link and physical security as part of these solutions. They should also review the management issues to see if they are relevant to their deployment and would require mitigation. For new deployments, the deployment efforts should consider a path to addressing these issues as a part of their design activities. The solution does not by itself provide a fully secure implementation without additional work.
Moderate	9-11	Two significant or one significant and several minor issues. For existing deployments, the chosen solution is likely deficient in security or management capabilities and the issues should be reviewed and upgrades developed as needed. For new deployments, the solution may be viable for pilots when applied to the triples it supports; such pilot deployments should consider a path to addressing these issues as a part of their design activities. The solution does not provide sufficient interoperability, management, and security to enable proper, full-scale deployment without additional work.
Moderate-Low	12-15	Multiple significant and minor issues. For existing deployments, the chosen solution is likely deficient in security or management capabilities, and the issues should be reviewed and upgrades developed as needed. Some solutions in this category may also be becoming obsolete from an interoperability perspective and if this is the case, then upgrades should be planned as soon as possible. For new deployments, the solution may be viable for pilots when applied to the triples it supports; such pilot deployments should consider a path to addressing these issues as a part of their design activities. The solution does not provide sufficient interoperability, management, and security to enable proper, full-scale deployment without additional work.
Low	16-31	One serious or several significant issues. This category often includes proprietary or partial solutions. The communications solution may fail to provide even a base level of interoperability and security. Consider alternative solutions or define specific revisions or upgrades that would provide a level of interoperability or security that are needed for the deployment.

Readiness Name	Scoring Values	Readiness or Suitability Description
Lowest	32+	Many serious issues. This category includes solutions that have not been standardized, or do not have a basic level of interoperability or security. Consider selecting a different communications solution or if this is not possible (e.g., a pilot of a new application that has not been standardized), take additional measures to provide an acceptable level of security or interoperability.

Standards Profiles

This lists the profiles that are used to carry out the communications of information in your project or to define the data to be communicated. For each profile, the tables show the short name, the long name, the type, the description of the profile, an editable comment, a checkbox of whether it is User Defined, and a checkbox of whether it is currently included in your project.

Standards

This lists the standards that are included in the ARC-IT database tables and have been assigned to a profile or as an information layer standard to a flow in your project. The table shows the name, the Standards Development Organization (SDO) that developed the standard, the Document number, the Document Title, a Description or abstract of the standard, an indication of the protocol layer that it best fits, and a checkbox indicating if the standard is user defined. Standards can be created in SET-IT in cases where the user knows of a new or different standard that will be needed for a particular interface.

To create a new standard, use the New Item / Standard menu option to bring up the Standards Details form.

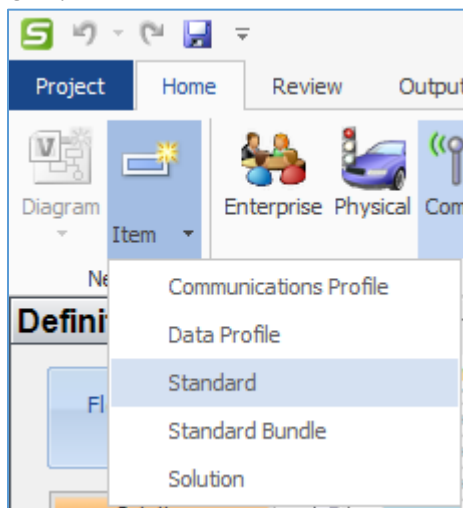

You can also start with an existing standard imported from ARC-IT and click Details and start making changes. As soon as you click OK it will inform you that it will create a customized user defined standard.

Standard Details

Full Name:

Name: User Defined

Description:

SDO: Document #:

Type: Stage:

Class: View:

URL: Version:

Layer(s):

<input checked="" type="checkbox"/> ITS Application Information Layer	<input type="checkbox"/> Transport Layer	<input type="checkbox"/> Network Layer
<input type="checkbox"/> Presentation Layer	<input type="checkbox"/> Data Link Layer	<input type="checkbox"/> Management Plane
<input checked="" type="checkbox"/> Application Layer	<input type="checkbox"/> Physical Layer	
<input type="checkbox"/> Session Layer	<input type="checkbox"/> Security Plane	

Abstract:

Issues:

Issue	Assignment Notes
*	

Contents

Data Dictionary: <input type="text" value="Fully"/>	Messages: <input type="text" value="Fully"/>	Dialogs: <input type="text" value="Fully"/>
Error Conditions: <input type="text" value="Fully"/>	Performance: <input type="text" value="Mostly"/>	Functional: <input type="text" value="Fully"/>
Test Procedures: <input type="text" value="Fully"/>	Test PICS: <input type="text" value="Fully"/>	Test Matrix: <input type="text" value="Fully"/>

Form Source: Grid - Standards

Once the user defined standard is created you will then be able to come back to the Definitions menus and use the "Profiles" and "Solutions" forms to assign that standard to a profile/solution.

Physical Interconnects (from Physical View)

This lists the physical interconnects from the physical view and their characteristics.

Assumptions and Constraints (from Physical View)

This lists the assumptions and constraints for the project. This table can be edited in any view but it is shared across the physical and enterprise views. The results can be output as a table or included as a section in your project's Concept of Operations (ConOps) document.

Comm View Definitions Grid Features

The Definitions menu in the Communications View works similarly to the grids in the Physical or Enterprise view.

- You can sort the tables by clicking the top column.

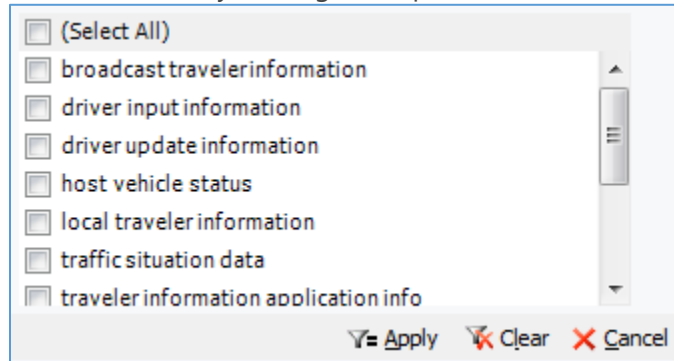

- You can click the right corner of the column heading to bring up the filter menu and choose to filter on a particular value or values. Use the Apply, Clear, or Cancel buttons as you would on the other views.
- Much of the information in the Communications View tables is read-only as it is largely based on ARC-IT, but as you add rows or customize the Details forms to create your own Profiles, your own unique Standards, or your own custom mappings of Flows to Profiles in the Triples table you will see the User Defined checkbox checked.

Other Diagram and Architecture Tools

This section describes how to use other tools, either on the diagrams or from the ribbon.

Creating New Items from the Ribbon

The Diagram ribbon contains an area called **New** that includes 2 choices: Diagram and Item. New Diagram has been described in "[Create a New Physical Diagram](#)" and "[Create a New Enterprise Diagram](#)" above.

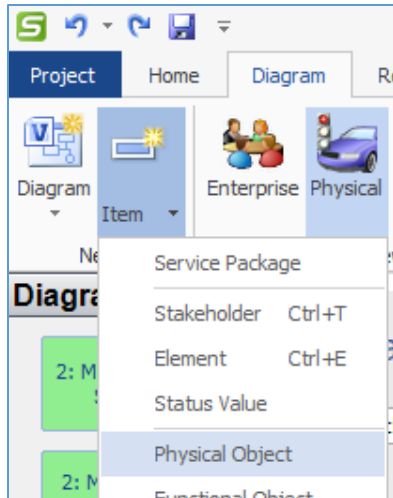

In the Physical View, The **New / Item** button allows you to create a new:

- Service Package,
- Stakeholder,
- Element,
- Status Value,
- Physical Object,
- Functional Object,
- Information Flow,
- Requirement,
- Standard, or
- Need

In the Enterprise View, the **New / Item** button allows you to create a new:

- Service Package,
- Stakeholder,
- Element,
- Status Value,
- Agreement,
- Expectation, or
- Role

In the Communications View, the **New / Item** button allows you to create a new:

- Communications Profile,
- Data Profile,
- Standard,
- Standard Bundle, or
- Solution

Creating a New Service Package

For **Service Packages**: you can create a new Service Package and then use that Service Package as the basis for new diagrams. That new Service Package can also be used to associate new operational Scenarios and sequences that will go into your Concept of Operations (ConOps).

To Create a New Service Package, select the Item button and Service Package from the pull-down. Alternatively, you can select <New Service Package> from the Diagrams window when you use the Service Packages pull-down.

The screenshot shows the 'Service Package Details' dialog box with the following fields and options:

- Name:** Local Application Name
- Description:** A text description of the new application (aka Service Package). This brief description will appear whenever you include a Layer 2 drawing for the Service Package in your ConOps. You can use the pull-down below to assign it to one of the pre-defined types and groups used to categorize the ARC-IT service packages.
- Abbreviation:** LN01
- User Defined
- Type:**
 - Convenience
 - Informational
 - Mobility
 - Safety
 - Environmental
 - Management
 - Regulatory
 - Support
- Group:**
 - Border Management
 - Incident Management
 - Sustainable Travel
 - Traveler Infor
 - Commercial Vehicle Operations
 - Maintenance and Construction
 - Traffic Management
 - V2I Safety
 - Core Services
 - Parking Management
 - Traffic Network
 - V2V Safety
 - Data Management
 - Public Safety
 - Traffic Signals
 - Vehicle Safety
 - Electronic Payment
 - Road Weather
 - Transit
 - Freight
 - Security
 - Transit Safety
- Service Area:** Support
- Parent SP:** (empty dropdown)
- Buttons:** OK, Cancel
- Form Source:** New Service Package

As shown in the figure above you give the new service package a name, a text description that will appear in output reports and the ConOps. You can then use the pull-downs to associate this new service package with one of the Types and Groups used to categorize ARC-IT service packages, formerly CVRIA applications.

Use the Service Packages report to list the service packages along with their type, group, name, descriptions, and the diagrams with which they are associated.

Once a service package diagram has been customized the Service Package Details window also shows the overall readiness based on all of the issues associated with the information flows between the different elements and their assigned communications solutions.

Then, as shown in the screenshot below, the Worst Readiness Score reflects the lowest level or worst level of readiness is listed along with the list of information flows and their issues that are driving that so-called Worst Readiness.

Name: Security and Credentials Management User Defined

Description: This service package is used to ensure trusted communications between mobile devices and other mobile devices or roadside devices and protect data they handle from unauthorized access. The service package grants trust credentials to qualified mobile devices and infrastructure devices in the Connected Vehicle Environment so that those devices may be considered trusted by other devices that receive trust credentials from the SCM service package. The service package allows credentials to be requested and revoked and secures the exchange of trust credentials between parties, so that no other party can intercept and use those credentials illegitimately. The service package provides security to the transmissions between connected devices, ensuring authenticity and integrity of the transmissions. Additional security features include privacy protection, authorization and privilege class definition, as well as non-repudiation of origin.

Abbreviation: SU08 Service Area: Support Parent SP: Security and Credentials Management

Type: Support Management
 Convenience Mobility
 Environmental Regulatory
 Informational Safety

Group: Core Services Public Safety V2V Safety
 Security Road Weather Vehicle Safety
 Border Management Sustainable Travel
 Commercial Vehicle Operations Traffic Management
 Data Management Traffic Network
 Electronic Payment Traffic Signals
 Freight Transit
 Incident Management Transit Safety
 Maintenance and Construction Traveler Information
 Parking Management V2I Safety

Worst Readiness Score: Moderate

Source	Destination	Flow	Ignore	Issue Severity	Issue
Equipped Vehicles	Security Credentials Management System	misbehavior report	<input type="checkbox"/>	Medium	Performance not fully defined (medium)
Equipped Vehicles	Security Credentials Management System	misbehavior report	<input type="checkbox"/>	Medium	Security inadequate
MC Freeway Management Center (BASIL/PINCH)	Security Credentials Management System	misbehavior report	<input type="checkbox"/>	Medium	Performance not fully defined (medium)
MC Freeway Management Center (BASIL/PINCH)	Security Credentials Management System	misbehavior report	<input type="checkbox"/>	Medium	Security inadequate
MCDOT CV Roadside Equipment	Security Credentials Management System	misbehavior report	<input type="checkbox"/>	Medium	Performance not fully defined (medium)
MCDOT CV Roadside Equipment	Security Credentials Management System	misbehavior report	<input type="checkbox"/>	Medium	Security inadequate
MCDPW GARLIC Information System	Security Credentials Management System	misbehavior report	<input type="checkbox"/>	Medium	Performance not fully defined (medium)
MCDPW GARLIC Information System	Security Credentials Management System	misbehavior report	<input type="checkbox"/>	Medium	Security inadequate

Form Source: Grid - Service Package Instances

OK Cancel

In other words, why is this service currently 'impractical'? It's because of these flows and the issues that they currently have. If you're working on a research project it is likely that you already are aware of those issues. You may also need to use this information in order to develop work arounds or some other risk mitigation strategy in order to have these interfaces supporting your project's service.

You can use the 'Ignore' flag to ignore those Issues and see if that changes the overall Readiness value for the service package.

Creating a New Stakeholder

For **Stakeholders**: you can create individual stakeholders – the agencies, organizations, or persons that own or operate a connected vehicle element. You can also create a *group* of stakeholders that may have a joint role with an element, e.g., a joint operations center. First, create the individual stakeholders that will be members of that group. Then you can create a new stakeholder and press the "group" button and select the member stakeholders for that group. Now that stakeholder group can be assigned roles with respect to elements just like individual stakeholders.

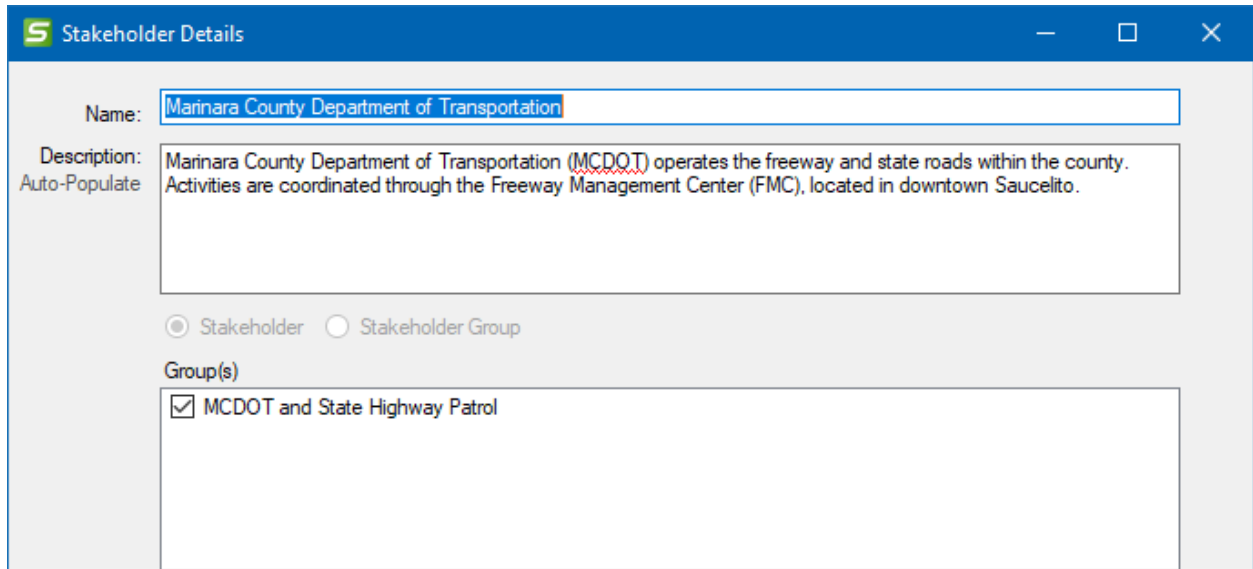

The screenshot shows a window titled "Stakeholder Details" with a blue header. The form contains the following fields:

- Name:** A text box containing "Marinara County Department of Transportation".
- Description:** A text box containing "Marinara County Department of Transportation (MCDOT) operates the freeway and state roads within the county. Activities are coordinated through the Freeway Management Center (FMC), located in downtown Saucelito." The text "Auto-Populate" is visible to the left of the description box.
- Stakeholder Type:** Two radio buttons are present: "Stakeholder" (which is selected) and "Stakeholder Group".
- Group(s):** A list box containing one item: "MCDOT and State Highway Patrol" with a checked checkbox.

You can also turn a 'regular' stakeholder into a group later if you decide it needs to be divided up. However, if it is already part of a group, as indicated in the example above, then it cannot be turned into a group. You cannot have groups of groups.

TIP: Use Control-t as a short-cut to create a new stakeholder

Creating a New Element

There are variations of the Element Details form depending on the Type of element – either a system element, environmental element, or a human element.

Creating a New System Element

This is the same screen as on the diagram and creating a new element from Shape Properties or creating a new element from the left menu.

The screenshot shows the 'Element Details' dialog box for a new element named 'State Flood Monitors'. The dialog is titled 'Element Details' and has standard window controls (minimize, maximize, close). The 'Name' field contains 'State Flood Monitors'. The 'Description' field contains '(Flood Monitoring System) In areas prone to flooding extra sensors can be used to detect when water levels are above certain configurable thresholds. Alarms can also be generated under certain rapidly changing conditions.' There is an 'Auto-Populate' link next to the description. The 'Status' is set to 'Project', 'Type' is 'System', and 'Class' is 'Field'. The 'Abbreviation' is 'SFM', 'Parent Element' is empty, and 'Domain' is 'Transportation'. Under 'Physical Object(s)', the 'Related' radio button is selected. A list of physical objects is shown, with 'Flood Monitoring System' checked. Below the list is a table for 'Stakeholder' with columns for 'Stakeholder', 'Role', and 'Status'. The table has two rows: 'State Highway Authority' with 'Manages' role and 'Project' status, and an empty row with an asterisk. At the bottom right are 'OK' and 'Cancel' buttons. At the bottom left, it says 'Form Source: New Element'.

Stakeholder	Role	Status
State Highway Authority	Manages	Project
*		

Note that some objects will automatically be checked but this will happen behind the scenes. For instance, if Center or Field are selected for the class and a subsystem (vs a terminator that represent objects outside the boundary of ITS) is chosen by the user then the Center and Field physical objects will automatically be mapped to the new element in order for the new element to automatically inherit the functionality of all center and field devices, accordingly. Also, the ITS Object physical object will automatically be checked when any ITS subsystem physical object is selected so that functionality common to all ITS centers and devices is included. Now you can choose the other Physical Objects that you need to associate with this element. Again, this will be happening behind the scenes so you won't see these extra generic physical objects.

Creating a New Human Element

Human elements are a little different. Sometimes physical view diagrams will show a human operator like a system operator, driver, or traveler.

When we create a human type of element, we can still assign a stakeholder to it – say an employer, or a higher-level organization. In the example below, "Metro Taxi Drivers," is mapped as a Driver that will appear as operators of vehicle onboard equipment and has a stakeholder assigned called "Metro Taxi" to show the company that manages the drivers.

Element Details

Name:

Description: [Auto-Populate](#) (Driver) The 'Driver' represents the person that operates a vehicle on the roadway. Included are operators of private, transit, commercial, and emergency vehicles where the interactions are not particular to the type of vehicle (e.g., interactions supporting vehicle safety applications). The Driver originates driver requests and receives driver

Status: Abbreviation:

Type: Parent Element:

Physical Object(s)

- Driver
- Archived Data Administrator
- Commercial Vehicle Administrator
- Commercial Vehicle Driver
- Commercial Vehicle Inspector
- Credentials Management System Operator
- Cyclist
- Data Distribution System Operator
- Emergency Personnel

Stakeholder	Status
<input type="text" value="Metro Taxi"/>	<input type="text" value="Project"/>

Form Source: Shape Properties - New

OK Cancel

TIP: if you leave the stakeholder blank SET-IT will automatically create a stakeholder with the same name as the Human element. This may be useful if you want to show the stakeholders that operate

the systems and then use the Enterprise view to show how they are related to other stakeholders in your project.

Creating a New Environment Element

Environment elements are different, also. Sometimes physical view diagrams will show an environmental terminator like a potential obstacle, the roadway environment, vehicles in traffic, or vulnerable road users – pedestrians, wheelchair-bound travelers, etc. As with other elements, start with a Name, use the Type pull-down, and select Environment. You will need to acknowledge that you don't want the physical objects that were automatically assigned when it thought you were creating a system element. Then choose the Class. When we create an environmental type of element, we are limited to 3 classes – field, personal or vehicle.

The screenshot shows the 'Element Details' window for an element named 'Items on the Shoulder'. The description is 'Our vehicles will be able to detect items such as debris, trees, posts, fences, etc., that may pose a hazard if the vehicle is too close to the edge of the roadway.' The configuration includes:

- Status: Project
- Type: Environment
- Class: Field (with a dropdown menu open showing 'Field', 'Personal', and 'Vehicle')
- Abbreviation: IOTS
- Parent Element: (empty dropdown)
- Physical Object(s):
 - Potential Obstacles
 - Roadway Environment
- Stakeholder table:

Stakeholder	Role	Status
	Manages	Project
	Owns	Project
*		

TIP: assigning stakeholders to environmental terminators is not necessary. Leave it blank.

Creating a New Status Value

Status refers to the relative deployment timeframe of an element, flow, resource, agreement, etc.

SET-IT includes basic status of "Existing", "Project", or "Future". "Project" is the default value which is to say the default value of things is that they are part of project currently being defined. Other status values may be needed to distinguish different phases or future projects.

Use the Status Value Details screen to give the new status value a name (up to 25 characters) and a description to explain what's unique about this status. Then decide if this should be the Default Status with the checkbox and use the Order field to set the order of this.

There are 8 possible values but one is always reserved for Not Applicable and its value is locked at 32767 (a really large number that happens to correspond with the Not Planned status in RAD-IT). Use the Order field to determine where each of the other 7 status values fall. This is how you can tell SET-IT whether Legacy comes before or after Existing or if Project comes before or after Future.

Status Values				
Order	Name	Description	Default	More...
1	Existing		<input type="checkbox"/>	Details
2	Project		<input checked="" type="checkbox"/>	Details
3	Future		<input type="checkbox"/>	Details
4	Future +25	What will happen in 25 years - beyond the project horizon and right at the boundary of the region's	<input type="checkbox"/>	Details
32767	Not Applicable		<input type="checkbox"/>	Details

This is used in the diagrams to encode the flows, elements, and functional objects within the elements, either with solid/dashed patterns or with grey scale coloring for the functional objects.

Creating a New Physical Object

ARC-IT provides a vast array of physical objects for connected vehicle and other intelligent transportation system objects as well as objects that interface with the transportation objects.

Sometimes, however, a project may need to go beyond ARC-IT and define their own physical objects. Use this menu to create the Physical Object and then it can be mapped to elements of the project.

To Create a New Physical Object, select the Item button and Physical Object from the pull-down.

The screenshot shows a software dialog box titled "Physical Object Details". It has a blue header bar with a green "S" logo and window control buttons. The main area contains a "Name" field with the text "Airport Operations Center". Below it is a "Description" field with the text "This center/centre (adapted from a European project) allows connected vehicle projects to interface with airports to show the coordination and system exchanges needed to support traveler information and mobility applications in and around an airport." There is a "User Defined" checkbox which is checked. To the right of this checkbox is a "Hyperlink" button. Below these are two dropdown menus: "Type" set to "System" and "Class" set to "Center". At the bottom right are "OK" and "Cancel" buttons. At the bottom left, it says "Form Source: New PObject".

As shown above, use the Physical Object Details screen to enter a Name and a Description for this object. Use the pull-downs to select the Type (Environment, Human, Other System, or System) and Class (ITS (super-class), Center, Field, Personal, Support, or Vehicle). The User Defined flag will automatically be set since this is not something previously defined by ARC-IT.

Optionally, you can use the "Hyperlink" button to use a hyperlink as a reference to further information about this object. See [Add a Hyperlink](#) for details.

If you choose to create an Environment type object the Class pull-down will be adjusted so you can only select from the 3 classes for which an environmental terminator would apply – field, personal, or vehicle.

Creating a New Functional Object

Functional Objects are shown as the smaller boxes within the physical objects on the drawings. They define the functionality that is required for each physical object to support one or more ITS or connected vehicle service packages. As with physical objects described above, ARC-IT comes with a long list of functional objects that were defined to support the service packages that made up the

original reference architecture. Sometimes, a project may have a need to define a unique piece of functionality and you can support that by creating your own "Functional Object" that can then be assigned to elements of your project.

Again, use the menubar to select "**New / Item / Functional Object**" to bring up the Functional Object Details form:

The screenshot shows a window titled "Functional Object Details" with a blue header bar containing a green 'S' logo. The window has standard Windows window controls (minimize, maximize, close). The main area contains the following fields and controls:

- Name:** A text box containing "Airport Ground Coordination".
- Description:** A text area with the text "This functional object coordinates airport activities with local transportation agencies - sharing information on road blockages, security incidents, dynamic message sign data, etc." and a label "Auto-Populate" to its left.
- User Defined:** A checkbox that is checked, with a "Hyperlink" button to its right.
- Physical Object:** A dropdown menu showing "Airport Operations Center".
- Buttons:** "OK" and "Cancel" buttons at the bottom right.
- Footer:** "Form Source: New Functional Object" at the bottom left.

As shown above, use the Functional Object Details screen to enter a Name and a Description for this object. Use the pull-down to assign the Physical Object for this functional object (this is where the functionality is housed. The list shown will include ARC-IT as well as new user defined physical objects). The User Defined flag will automatically be set since this is not something previously defined by ARC-IT.

Behind the scenes as a functional object is added to a physical object SET-IT will adjust the Kind of physical object from a Terminator (no functionality defined) to an ITS Subsystem (functionality defined). If a user removes all of the functional objects mapped to a particular physical object, then SET-IT will change the Kind back to a terminator. This is to support the inclusion of generic functions like the ITS and Center/Field functions that are common among other ITS subsystem elements.

Optionally, you can use the "Hyperlink" button to use a hyperlink as a reference to further information about this object. See [Add a Hyperlink](#) for details.

Creating a New Information Flow

For Flows: Selecting New / Information Flow, brings up a blank **Information Flow Details** window. This allows you to decide on every aspect of that flow: its name, description, source, destination, and

all of the flow characteristics. SET-IT will pre-populate default values for the flow characteristics based on the physical objects in the source and destination.

Information Flow Details

Name: flood monitoring system data User Defined

Alias: FLOOD-1 Apply Alias

Description: This flow is to share information between controlling centers about the status of the flood control systems. This would include status of the center's field equipment with location and time stamps for the information.

Type: System [Hyperlink](#)

Encryption: True Using FIPS Latency: Low Initiator: Source

Authenticability: True Time Context: Recent Acknowledgment: True

Cardinality: Unicast Spatial Context: Regional Interoperability: Regional

FIPS Confidentiality: Moderate Integrity: Moderate Availability: Moderate

Confidentiality Basis: Confidentiality value set to default by SET-IT. Integrity Basis: Need to maintain the authority and legitimacy of the sending system. Availability Basis: Availability value set to default by SET-IT.

Elements Physical Objects

Source Physical Object	Destination Physical Object	Status	DDS	WAIDS	RCU	ICE	Replaces
Maint and Constr Management Center	Traffic Management Center	Project	<input checked="" type="checkbox"/>	<input type="checkbox"/>	<input type="checkbox"/>	<input checked="" type="checkbox"/>	
Traffic Management Center	Maint and Constr Management Center	Project	<input checked="" type="checkbox"/>	<input type="checkbox"/>	<input type="checkbox"/>	<input checked="" type="checkbox"/>	0

Source Functional Objects:

- TMC Environmental Monitoring
- TMC Advanced Rail Crossing Management
- TMC Automated Vehicle Operations
- TMC Barrier System Management

Destination Functional Objects:

- MCM Environmental Information Processing
- MCM Automated Treatment System Control
- MCM Data Collection
- MCM Environmental Information Collection

Form Source: New Flow

Note that the name of a flow cannot contain a parenthesis. If an Alias is used (see below) this would create a conflict when it generates outputs because the original flow name will be listed in parentheses.

You can use the radio buttons below the description to choose either Element or Physical Object. If you selected **Element** with the radio button you will choose from a list of Elements already defined in your project inventory. If you selected **Physical Object** with the radio button you will choose from a list of all of the physical objects from the ARC-IT database along with user defined physical objects. As you select the source and destination physical objects the lower part of the screen will then list the available functional objects, if applicable for that chosen physical object. If the selected physical object is a 'terminator' on the edge of ITS boundary with no transportation-specific functionality, then it will not have any functional objects.

Once the source and destination are selected then you assign all of the other flow characteristics and select OK. This flow will now be available when you are creating interfaces on your diagrams. It will also appear in the list of Information Flows on the Definitions menu.

Optionally, you can use the "Hyperlink" button to use a hyperlink as a reference to further information about this flow. See [Add a Hyperlink](#) for details.

You can also add and apply an **Alias** for the flow when you want that alias to be used on your diagrams and outputs. A flow alias is a way to use a customized name for an information flow while

retaining the mappings to the ARC-IT reference model for that flow. For example, if you are doing a connected vehicle project to collect probe data from passing vehicles for traffic monitoring purposes you may want to just show the term “BSM” for the basic safety message defined in the SAE 2735 standard rather than the full name of the ARC-IT information flow, “vehicle location and motion for surveillance”. It isn’t common for a user defined flow to also have an alias.

- Alias names cannot contain a parenthesis. This would create a conflict when it generates outputs because the original flow name will be listed in parentheses.

NOTE: If you change the characteristics for a user defined physical object (PObject) flow triple then any element triples using that same PObject flow triple need to reflect those characteristic changes and vice versa. Changes to certain characteristics in the information flows can spawn the selection of different communications solutions so these need to be kept in sync.

Creating a New Requirement

In order to create a new requirement, click New Item and Requirement from the menu. Enter a number – use a leading 0 to help when sorting as in 01, 02, 03, etc. Enter the text of the requirement and assign or trace it to a Need in the Supports Need(s) area.

Next use the Source pull-down to select from the existing list of sources. If you don’t see your source, there click <New Source> and enter the name of the source in the New Requirement Source dialog box

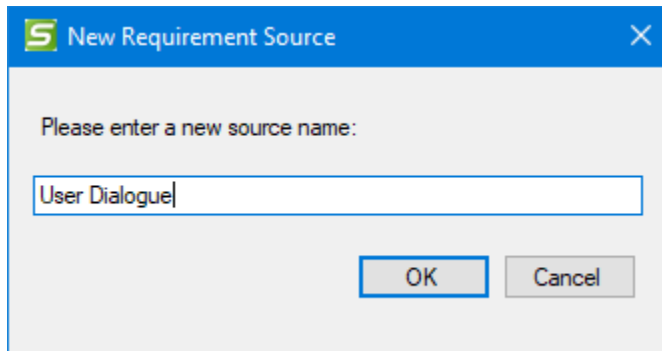

Next select one of the 4 verification methods to help with your test planning – inspection, analysis, demonstration, or test.

Next, select a functional object to which this requirement belongs. As you do this the Element area will open up and you can select which element to assign it to if there is a match between the element and functional objects.

Optionally, enter a comment then click OK.

Requirement Details

Number: 08

Requirement: The Maint and Construction Monitoring system shall categorize the status of the equipment being monitored by severity of the issue.

User Defined Hyperlink

Supports Need(s):

MC09: Infrastructure Monitoring (Copy 1): 01

Source: User Dialogue Creation Date:

Verification: Demonstration Last Update Date:

Functional Object: MCM Infrastructure Monitoring

Comment:

Include	Element	Functional Object
<input checked="" type="checkbox"/>		MCM Infrastructure Monitoring
<input type="checkbox"/>		

Form Source: New Requirement

Creating a New Physical Standard

In the Physical View ARC-IT lists standards that apply to physical or functional objects. These standards govern the manufacture, configuration of a physical hardware or of the functionality it contains. SET-IT's New Item menu can be used to create a new user defined standard in case the standard your project needs to access hasn't been defined yet in ARC-IT.

See [Creating a New Standard](#) in the communications view section for details.

What is the difference between Physical Standards and Communications Standards? Within ARC-IT, communications standards include all standards and specifications that make up part of the communications 'stack', as defined in the [communications viewpoint](#). That is, any standards dealing with signaling (e.g., Ethernet), networking and transport (e.g., TCP/IP), middleware (e.g., HTTPS), cybersecurity (e.g. IETF X.509) and application layer specifications (e.g., GTF5). Physical standards on the other hand are more concerned with electrical, structural and environmental concerns (power, cabinets, temperature ranges etc.) of a particular device or type of device, such as a traffic signal controller, e.g., ITE ATC 5301.

Creating a New Need

Needs are statements describing a high-level identification of user needs and system capabilities in terms that all project stakeholders can understand, agree on, and use to form a shared

understanding by system owners, operators, maintainers, and developers on the who, what, why, where, and how of the system.

SET-IT includes a set of needs for each Service Package imported from the ARC-IT reference architecture that provide a starting point. You can also use the New / Item menu to create a new need.

Need Area	Need #	Priority	Comment
MC09: Infrastructure Monitoring (Copy 1)	8	High	
*			

Fill in the text of the Need, use the pull-down to select a Service Package to connect it to one of the services in your project. Then use the Need Area grid to assign it to a Need Area (sometimes this is the same as the service package but not always), give it a Need #, select a priority, and optionally enter a comment, perhaps to justify this particular need for your project.

The Need will be assigned to the Needs Grid where you can edit it along with the other needs. See the [Needs](#) section for more information.

If you edit a Need that came from ARC-IT, then SET-IT will turn it into a User Defined need. You can then edit it and use it as you choose. SET-IT will automatically retain the requirements that were mapped to that original need from ARC-IT.

Creating a New Agreement, Expectation, or Role

For the Enterprise View, the New / Item menu has choices that include adding relationships:

- Agreement
- Expectation
- Role

In each case another window will open allowing you to provide the name, description, and the other details appropriate for that item.

The **New / Agreements** and **New / Expectations** windows allow you to create a new type of agreement or stakeholder expectation that may not have been defined by ARC-IT. This window allows you to specify the name of the agreement, give it a description, identify the type, select the

stakeholders involved, and check whether this is bi-directional or not. If not, then the stakeholder on the left will be considered the source or initiator of the agreement or expectation.

The New / Roles window allows you to create a new type of role that a stakeholder can play with respect to a system element. ARC-IT already defines 12 different roles listed here but you may have a need to add to that list.

See [Creating a Role](#) for the list of ARC-IT Defined Roles

Creating a New Communications or Data Profile

The communications view allows you to create new communications or data profiles. Comm Profiles are sets of standards that comprise the layered communications stacks for a sender and receiver to exchange information. A data profile includes protocols at the ITS Information (or ITS Application Entity), Facilities, Management and/or Security layers.

ARC-IT defines 55 communications profiles and 88 data profiles but there may be occasions when a unique situation is defined and a unique user-defined profile is required.

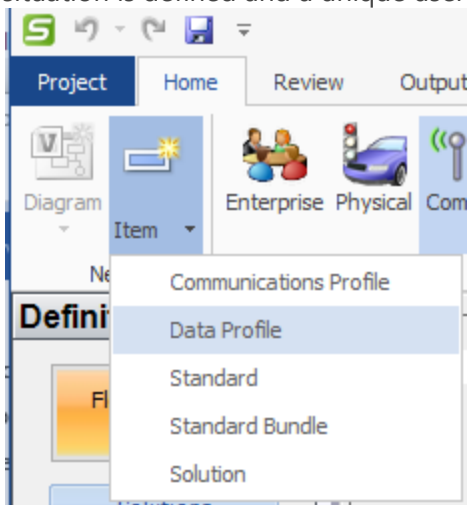

Use the menubar to select Item and Communications or Data Profile when you are in the Communications View. The window will ask for a Short Name, a long name, a text description, and an optional comment.

Data Profile Details

Name: User Defined

Full Name:

Description:

Region: AU EU US CA

Standards Issues Information Flow Triples

ITS Information Management Security Facilities

Application Specific

ASTM Archiving Traffic Data

ASTM Metadata to support ADMS

Bundle: ADMS

Bundle: DATEX

Bundle: IEEE 1512

Bundle: ISO Probe Data

CEN 12896-1: Transmodel Common Concepts

CEN 12896-2: Transmodel Public Transport Network

CEN 12896-3: Transmodel Timing Information

CEN 12896-4: Transmodel Operations monitoring and control

CEN 12896-5: Transmodel Fare Management

CEN 12896-6: Transmodel Passenger Information

CEN 15213-4 After-theft systems - long range comms

CEN 15531-3 PublicTrans - SIRI Functional interfaces

CEN 15531-5 PublicTrans - SIRI Situation Xchange

CEN 15722 ESafety - ECall - Minimum Data Set

CEN 16102 eCall - Op Reqs for 3rd party Support

CEN 16157-1 DATEX for TM&I - Context & Fmwrk

CEN 16157-2 DATEX for TM&I - Location Refer

CEN 16157-3 DATEX for TM&I - Situation Public

CEN 16157-4 DATEX for TM&I - VMS Publicatic

CEN 16157-5 DATEX for TM&I - M/E Data Pub

CEN 16157-6 DATEX for TM&I - Parking Public

CEN 16614-2 PublicTrans - NeTEx - Timetables

CEN 16614-3 PublicTrans - NeTEx - Fares Xcha

CEN 17380 Controlled Zone Management

DDS-Xtypes

DMS and RWIS (AU)

ETSI 101 556-1 App: EV Charging Spot

ETSI 101 556-3 App: EV Energy Reservation

ETSI 102 638 ITS BSA

ETSI 102 894-2 U&AR Common Data Dict

General Transit Feed Specification

GTFS Realtime

HIDO DSRC I2V Downlink Data Format

HIDO DSRC V2I Uplink Data Format

IEEE 1512.0 Incident Mgmt - Common

Form Source: New Profile

OK Cancel

Fill-in the fields of name, full name, description, and region applicability. Then use the Standards tabs to select the standards that will be used and mapped at each layer.

When you say OK a new user defined row is added to the Comm or Data Profiles grid on the Definitions menu for Communications View. This new profile is now available to be selected when you create a user defined Solution.

Creating a New Standard

In the Communications View ARC-IT lists standards that apply to the movement of data through the physical view's information flows as well as the standards for the various layers of the

communications stack. SET-IT's New Item menu can be used to create a new user defined standard in case the standard your project needs to access hasn't been defined yet in ARC-IT.

In the physical view, standards can also be defined and applied to physical objects themselves and, in some cases, to specific functional objects within those physical objects. The process of defining a new physical standard or a communications standard works the same way. When you are in either Communications or Physical View use the New Item menu and select Standard.

From either view, clicking "Standard" will cause a new Standard Details form to open. What you see will depend on whether you were in Physical or Communications view. Certain fields will only appear if you are in Communications view (shown below).

The screenshot shows a 'Standard Details' dialog box with the following fields and options:

- Full Name:** Text input field.
- Name:** Text input field with a **User Defined** checkbox.
- Description:** Large text area.
- SDO:** Dropdown menu.
- Document #:** Text input field.
- Type:** Dropdown menu.
- Stage:** Dropdown menu (set to 'Unknown').
- Class:** Dropdown menu.
- View:** Dropdown menu.
- URL:** Text input field.
- Version:** Text input field.
- Layer(s):** A grid of checkboxes for:
 - ITS Application Information Layer
 - Transport Layer
 - Network Layer
 - Presentation Layer
 - Data Link Layer
 - Management Plane
 - Application Layer
 - Physical Layer
 - Session Layer
 - Security Plane
- Abstract:** Text area.
- Issues:** A table with columns 'Issue' and 'Assignment Notes'. A row with an asterisk (*) is visible.
- Contents:** A grid of dropdown menus for:
 - Data Dictionary: Unknown
 - Messages: Unknown
 - Dialogs: Unknown
 - Error Conditions: Unknown
 - Performance: Unknown
 - Functional: Unknown
 - Test Procedures: Unknown
 - Test PICS: Unknown
 - Test Matrix: Unknown

Buttons: **OK** and **Cancel**.
 Form Source: New Standard

From here you can fill in as much information as you know – Name (a shorter name by which the standard is known, e.g. Wi-Fi vs IEEE 802.11ax, Title (official name from the organization), Document

#, SDO or Standards Development Organization that publishes and maintains the standard, a brief description of the standard perhaps pulled from its abstract, a comment about why this standard is being used on your project, and then Type.

The following Types are available:

- Communications
- Hardware
- Meta
- Other
- Testing

The View can also be set to Physical, Communications, or Both. Clicking Physical will make the communications view layers area read-only.

S Standard Details

Full Name: Standard for the Design and Construction of Gantries in the Use of Dynamic Message Signs

Name: DMS Gantry Standard User Defined

Description: This standard provides standard specifications on materials, dimensions, other controlling guidelines for the design and construction of gantries used in over-the-road installations of dynamic message signs (DMS).

SDO: NEMA Document #: D-11-1

Type: Hardware Stage: Unknown

Class: SDO Normative View: Physical

URL: Version: 2.2

Layer(s):

<input type="checkbox"/> ITS Application Information Layer	<input type="checkbox"/> Transport Layer	<input type="checkbox"/> Network Layer
<input type="checkbox"/> Presentation Layer	<input type="checkbox"/> Data Link Layer	<input type="checkbox"/> Management Plane
<input type="checkbox"/> Application Layer	<input type="checkbox"/> Physical Layer	
<input type="checkbox"/> Session Layer	<input type="checkbox"/> Security Plane	

Abstract: This standard includes the objects and rules for construction and inspection of DMS Gantries.

Issues: *

Issue	Assignment Notes

Contents

Data Dictionary: Unknown	Messages: Unknown	Dialogs: Unknown
Error Conditions: Unknown	Performance: Unknown	Functional: Unknown
Test Procedures: Unknown	Test PICS: Unknown	Test Matrix: Unknown

Form Source: New Standard

OK Cancel

Creating a Custom SDO:

As you create your custom standard and you look through the Standards Development Organizations (SDOs) you may not find the one you need and want to create your own. Simply type out the name of your SDO in the SDO field and a Pop-Up will ask if you want to create a new SDO.

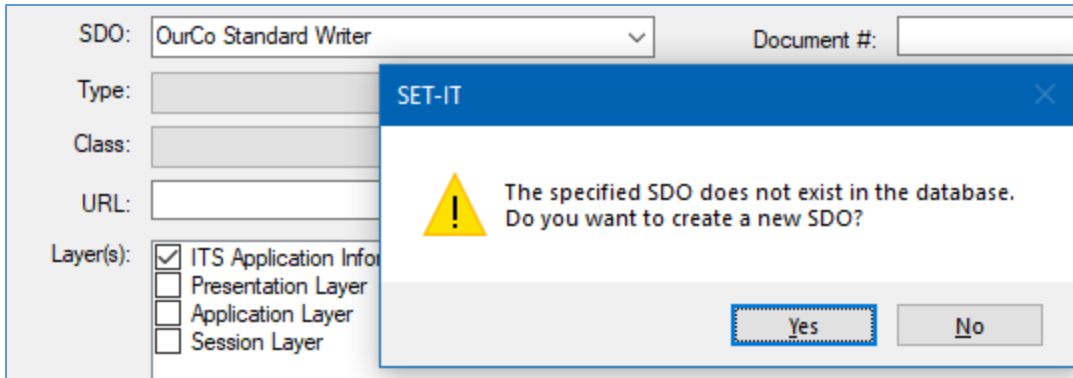

When you click Yes, SET-IT will add your SDO to the database and it can be assigned to other user defined standards.

Assigning a New Standard

Map the new physical standard to Physical and Functional Objects on the Physical Objects Standards grid. Click the In My Project filter and click False and Apply to include all rows, not just the ones in your project currently. This makes a New row available at the bottom of the grid. Go all the way to the bottom of the grid and click in the new (*) row.

<input type="checkbox"/>	Traffic Management Center	TMC Reversible Lane Management	NEMA ITS & Cyber and Physical Security	<input type="checkbox"/>
<input type="checkbox"/>	Traffic Management Center	TMC Road Weather Micro-Prediction	CTI 4001 RSU	<input type="checkbox"/>
<input checked="" type="checkbox"/>	Traffic Management Center	TMC Roadway Warning	DMS Gantry	<input type="checkbox"/>
<input type="checkbox"/>	Traffic Management Center	TMC Safeguard System Management	FIPS 140-2	<input type="checkbox"/>
<input type="checkbox"/>	Traffic Management Center	TMC Signal Control	ISO 10992 Nomadic Devices for ITS	<input type="checkbox"/>
<input type="checkbox"/>	Traffic Management Center	TMC Signal Enforcement	ISO 15623 Fwd Collision Performance	<input type="checkbox"/>
<input checked="" type="checkbox"/>	Traffic Management Center	TMC Speed Warning	ISO 21217 Architecture	<input type="checkbox"/>
<input type="checkbox"/>	Traffic Management Center	TMC Standard Rail Crossing	ISO 22179 Full Speed ACC Performance	<input type="checkbox"/>
<input type="checkbox"/>	Traffic Management Center	TMC Traffic Gap Assist	ISO 24014-2 Transit - Fare Practices	<input type="checkbox"/>
<input checked="" type="checkbox"/>	Traffic Management Center	TMC Traffic Information Dissemination	ISO 24100 Probe Vehicle Data Protection	<input type="checkbox"/>
<input type="checkbox"/>	Traffic Management Center	TMC Traffic Metering	ITE ATC	<input type="checkbox"/>
<input type="checkbox"/>	Traffic Management Center	TMC Variable Speed Limits	ITE ATC API	<input type="checkbox"/>
<input type="checkbox"/>	Traffic Management Center	TMC Work Zone Traffic Management	ITE ATC ITS Cabinet	<input type="checkbox"/>
<input type="checkbox"/>	ITS Roadway Equipment	Roadway Traffic Information	ITE ATC Model 1-2070	<input type="checkbox"/>
<input type="checkbox"/>			DMS Gantry	<input checked="" type="checkbox"/>
<input type="checkbox"/>				<input checked="" type="checkbox"/>

Use the pull-downs to select the physical object, functional object, and standard. You should be able to find your new standard in the list of standards. Once you enter the new row the standard is now in your grid.

In My Project	Physical Object	Functional Object	Standard	User Defined	More...
<input checked="" type="checkbox"/>	ITS Roadway Equipment	Roadway Traffic Information Dissemination	DMS Gantry Standard	<input checked="" type="checkbox"/>	Details
<input checked="" type="checkbox"/>	ITS Object	ITS Security Support	FIPS 140-2	<input type="checkbox"/>	Details
<input type="checkbox"/>	ITS Object	ITS Communications Support	ISO 21217 Architecture	<input type="checkbox"/>	Details

You can select "Unspecified" for Functional Object if you want this to apply to any element that is mapped to the Physical Object.

From here you can click Details to change any of the information about the standard. Or you can go to the Elements Standards grid and see that your new standard has been automatically mapped to any elements in your project inventory that match the Physical/Functional Objects of the new standard.

Elements Standards		Comment
Element	Standard	
Cellular-Equipped Vehicles	ISO 21217 Architecture	
Equipped Vehicles	FIPS 140-2	
Equipped Vehicles	ISO 21217 Architecture	
MC Field Maintenance Equipment	ISO 21217 Architecture	
MC Freeway Management Center	FIPS 140-2	
MC Freeway Management Center	ISO 21217 Architecture	
MC Freeway Management Center	NEMA TS 8 Cyber and Physical Security	
MCDOT CV Roadside Equipment	CTI 4001 RSU	
MCDOT CV Roadside Equipment	FIPS 140-2	
MCDOT CV Roadside Equipment	ISO 21217 Architecture	
MCDOT Detectors	ITE ATC ITS Cabinet	
MCDOT Detectors	NEMA TS 8 Cyber and Physical Security	
MCDOT Detectors	NEMA TS4 Hardware Standards for DMS	
▶ MCDOT Dynamic Message Signs	DMS Gantry	
MCDOT Dynamic Message Signs	ISO 21217 Architecture	

For other types of standards, including Data or Communications, the form will expand to allow you to select the source and destination physical objects and the information flows, i.e., the triples, that apply to this standard.

Standard Details

Full Name: Specification for the Transmission of Vehicle Signage Data over Wireless Networks

Name: Vehicle Signage Data Spec User Defined

Description: Defines the data for the in-vehicle signage application - focused on work zone and other safety events.

SDO: ASTM Document #: x0055

Type: Communications Stage: Unknown

Class: SDO Normative View: Communications

URL: Version: Sb

Layer(s): ITS Application Information Layer Transport Layer Network Layer
 Presentation Layer Data Link Layer Management Plane
 Application Layer Physical Layer
 Session Layer Security Plane

Abstract:

Issue	Assignment Notes
* Dialogs are not fully defined (medium)	

Contents

Data Dictionary: Fully Messages: Partially Dialogs: Partially

Error Conditions: Partially Performance: Mostly Functional: Mostly

Test Procedures: Partially Test PICS: Partially Test Matrix: Partially

Form Source: New Standard

Once the standard has been created it will be available for selection and mapping to a Communications Profile that will then be, in turn, mapped to a Communications Solution, and then mapped to an information flow triple. See the Communications View for more information.

Creating a New Standard Bundle

Use the form to fill in the full name, a shorter name and a description of the bundle. Then use the pull-downs to select the primary Standards Development Organization (SDO) for this bundle (if they are all from one organization), the Stage of the standard in its life cycle; e.g., approved, draft, etc.; the

type of standards that make up the bundle (Comm, hardware, meta, other, or testing); and the class of standards in the bundle – Normative or Informative. Use the checkboxes to select the Layer or Layers the bundle is part of. Finally, use the rows to select the standards that make up the bundle. Enter numbers in the Order column to indicate how you would like the members of the bundle to be sorted. The Membership Type indicates whether the standard is Required to be in the bundle or whether it is optional or perhaps an alternative way to doing what the bundle is supposed to do. The Required Security and Required Management Standard columns let you indicate what, if any, security or management needs to be in place when the standard is part of this bundle.

Click OK and it will be available in the Communications view.

Creating a New Solution

Communications Solutions are a combination of a Data Profile and a Communications Profile. Click New Item and Solution to bring up a blank Solutions Details form.

Solution Details

Name: User Defined

Data Profile: Comm Profile:

Description:

Region: AU EU US CA

Comm Class: Applied to:

Standards

ITS Information Management Security Facilities Transport/Networking Access

- Bundle: DATEX
- DMS and RWIS (AU)
- Vehicle Signage Data Spec
- (None)
- Addressed Elsewhere in Stack
- Application Specific
- ASTM Archiving Traffic Data
- ASTM Metadata to support ADMS
- Bundle: ADMS
- Bundle: IEEE 1512
- Bundle: ISO Probe Data
- CEN 12896-1: Transmodel Common Concepts
- CEN 12896-2: Transmodel Public Transport Network
- CEN 12896-3: Transmodel Timing Information
- CEN 12896-4: Transmodel Operations monitoring and control
- CEN 12896-5: Transmodel Fare Management
- CEN 12896-6: Transmodel Passenger Informati
- CEN 15213-4 After-theft systems - long range cc
- CEN 15531-3 PublicTrans - SIRI Functional inte
- CEN 15531-5 PublicTrans - SIRI Situation Xcha
- CEN 15722 ESafety - ECall - Minimum Data Set
- CEN 16102 eCall - Op Reqs for 3rd party Suppo
- CEN 16157-1 DATEX for TM&I - Context & Fmw
- CEN 16157-2 DATEX for TM&I - Location Refer
- CEN 16157-3 DATEX for TM&I - Situation Public
- CEN 16157-4 DATEX for TM&I - VMS Publicatic
- CEN 16157-5 DATEX for TM&I - M/E Data Publ
- CEN 16157-6 DATEX for TM&I - Parking Publica
- CEN 16614-2 PublicTrans - NeTEx - Timetables
- CEN 16614-3 PublicTrans - NeTEx - Fares Xcha
- CEN 17380 Controlled Zone Management
- DDS-Xtypes

Form Source: Grid - Solutions

Use the pull-downs to select a Data profile and a Communications Profile. If you don't see the profile, you need or if you need to make changes to an existing profile click Cancel and edit or create the profiles you need first.

As you select the Profiles the standards portion of the screen will be populated as will the Issues tab based on the Issues associated with the underlying profile or standards.

You can use the Applied to pull-down to indicate which types of interfaces this solution applies to – flow triples with Data Distribution systems acting as intermediaries, those that don't, or either.

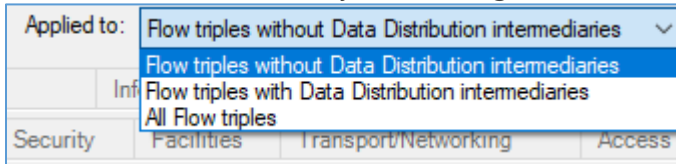

You can also click the Information Flow Triples tab to see and assign information flow triple combinations that should use this new communications solution.

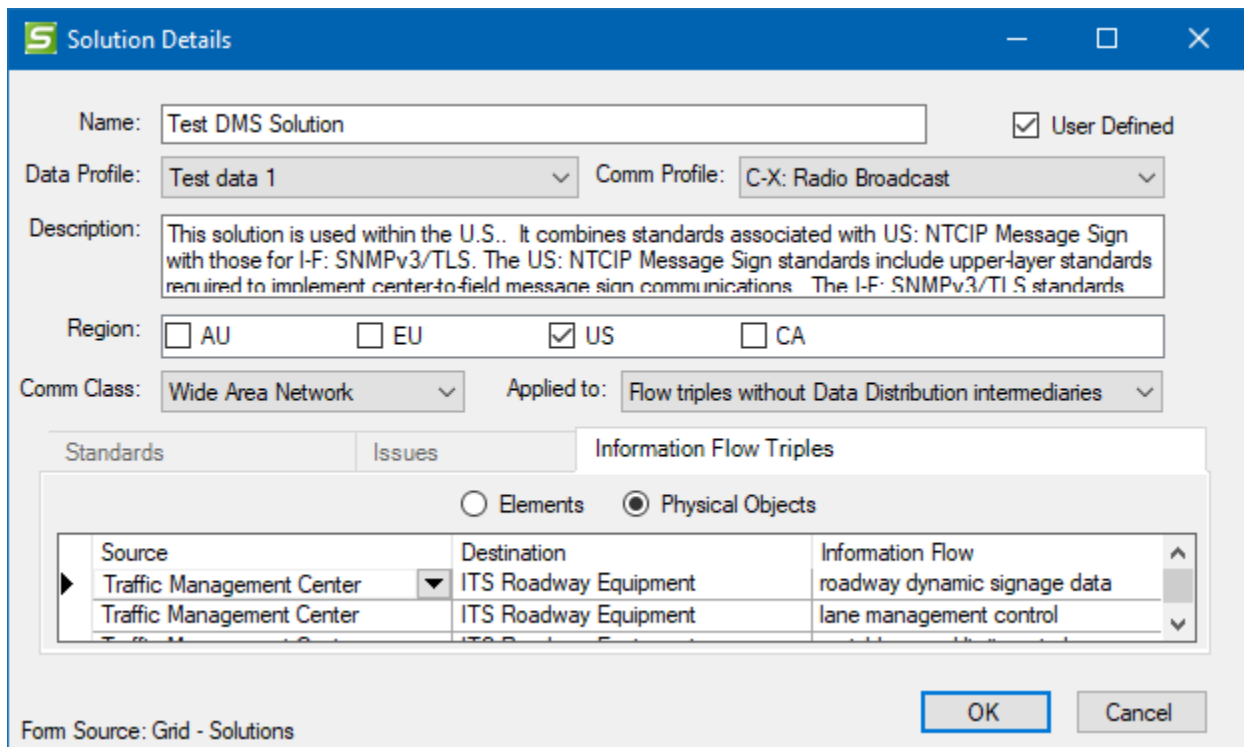

Now, every time that combination of information flows is used in your architecture it will pick-up this solution assignment when the Communications assignments are run.

NOTE: if a flow alias has been applied then the alias will appear in this list followed by the original flow name in parentheses.

Add Comments or Notes to a Diagram

In order to provide commentary about a diagram there are 2 shapes on the Stencil: a Cloud for comments to the reader or a white Rectangle to provide other specific Notes about the diagram.

In either case, drag the shape from the stencil onto the drawing surface.

Edit the **Comments** cloud or **Notes** box by double-clicking on the shape and opening Shape Properties.

Edit the text in **Shape Properties**.

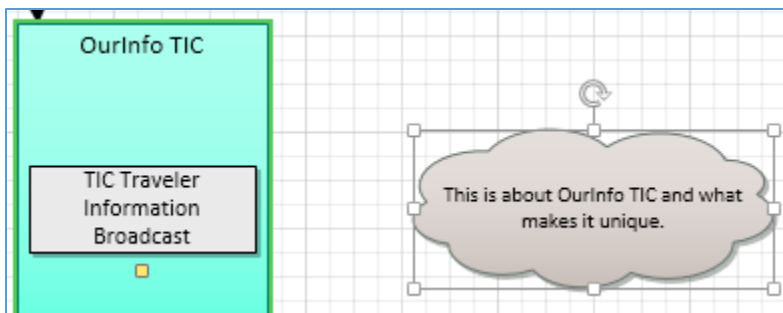

Click the **refresh** button or simply click on another part of the drawing to store the editing.

TIP: Use the little Yellow Square to connect a comment cloud with an element. Just find the yellow square and drag it onto the element. Now when you move the element around the comment cloud will follow.

The Notes box works similarly to the Comment cloud. Drag the Note shape from the Stencil onto a spot on the diagram. Then click the shape or use Shape Properties to enter and edit your text.



Physical Legend								
Flow Time Context	Flow Spatial Context	Flow Routing	Flow Status	Flow Cardinality	Flow Control	Flow Security	Elements	Functional Objects
1 - Now	A - Adjacent D - National	(c) - Routed through comm element	Existing	Unicast	Transaction Initiated	Clear text, No Authent.	Center	Existing
2 - Recent	B - Local E - Continental	(d) - Routed through DDS	Project	Multicast	By left-hand party	Encrypted, No Authent.	Vehicle	Project
3 - Historical	C - Regional	(Abbr) - Terminal	Future	Broadcast	Receipt acknowledged	Clear text, Authent.	Support	Future
4 - Static			Not Applicable			Encrypted, Authent.	ITS	
							People	Environment
								Not Applicable

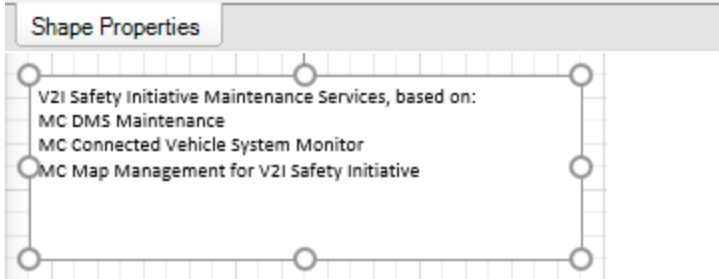

Add a Legend from SET-IT Stencil to a Diagram

This process works in either Physical or Enterprise View. Create a New Diagram, or open an Existing Diagram.

Select the **Legend** from the stencil on the left.

Drag the **Legend** to the drawing area, either a *horizontal* or *vertical* legend.

Place the **Legend** box on the desired area in the diagram.

The legend for the Physical Layer 2 diagram looks like this:









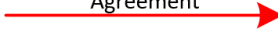

Physical Legend								
Flow Time Context	Flow Spatial Context	Flow Routing	Flow Status	Flow Cardinality	Flow Control	Flow Security	Elements	Functional Objects
1 - Now	A - Adjacent D - National	(c) - Routed through a comm element	Existing	Unicast	Transaction Initiated	Clear text, No Authent.	Center	Existing
2 - Recent	B - Local E - Continental	(d) - Routed through a DDS	Project	Multicast	By left-hand party	Encrypted, No Authent.	Vehicle	Project
3 - Historical	C - Regional	(Abbr) - Terminal	Future	Broadcast	Receipt acknowledged	Clear text, Authent.	Support	Future
4 - Static			Not Applicable			Encrypted, Authent.	ITS	
							People	Environment
								Not Applicable

The legend for the Physical Layer 0 or Layer 1 diagrams looks like this:

Physical Legend						
Interconnect Time Context	Interconnect Spatial Context	Interconnect Status	Interconnect Cardinality	Interconnect Security	Elements	Functional Objects
1 - Now	A - Adjacent D - National	Existing	Unicast	Clear text, No Authent.	Center	Existing
2 - Recent	B - Local E - Continental	Project	Multicast	Encrypted, No Authent.	Vehicle	Project
3 - Historical	C - Regional	Future	Broadcast	Clear text, Authent.	Support	Future
4 - Static		Not Applicable		Encrypted, Authent.	ITS	
					People	Environment
						Not Applicable

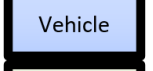
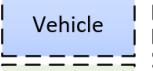
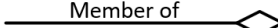
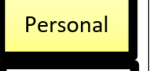
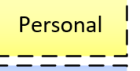
Note that the contents of the legend for the Layer 0/1 diagrams is different – interconnects instead of flows; and no routing indicators.

The legend for the Enterprise Layer 0 diagram looks like this:

Enterprise Legend			
Connectors	Status	Enterprise Objects	Resources
Agreement 	Existing	 Center	 Center
Expectation 	Project	 Field	 Field
Role 	Future	 Vehicle	 Vehicle
Member of 	Not Applicable	 Personal	 Personal
		 Support	 Support
		 Unspecified	 Nomadic

The enterprise diagram legend shows the Connectors, Status, Enterprise Objects, and Resources.

TIP: include a legend on at least one of each type of your diagrams so that your users will be able to understand all of the symbols, line styles, and colors.

Update a Physical Layer 0 or Layer 1 Diagram

The Update Diagram tool lets you add or remove elements or interconnects from the Layer 0 or Layer 1 diagrams based on changes to your Layer 2 diagrams. This prevents you from having to redraw the entire diagram when you may have made only minimal changes to your project.

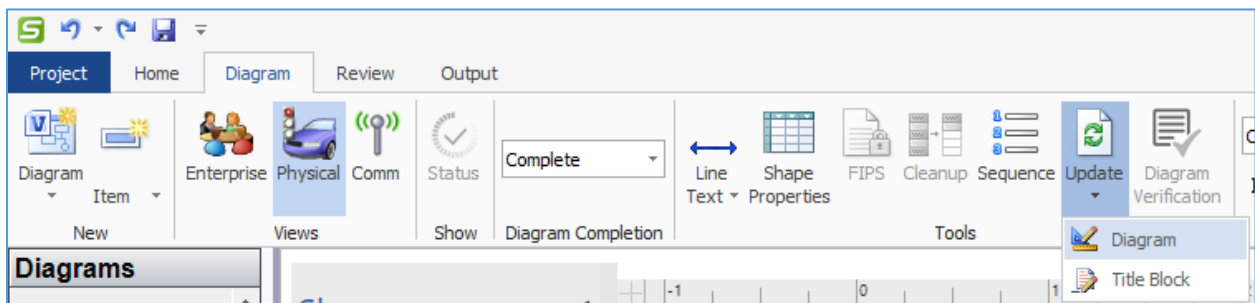

Click the caret under the “Update” button and select “Diagram” to bring up the Update Diagram tool. This is only active when you are on one of the higher-level diagrams – Layer 0 or Layer 1.

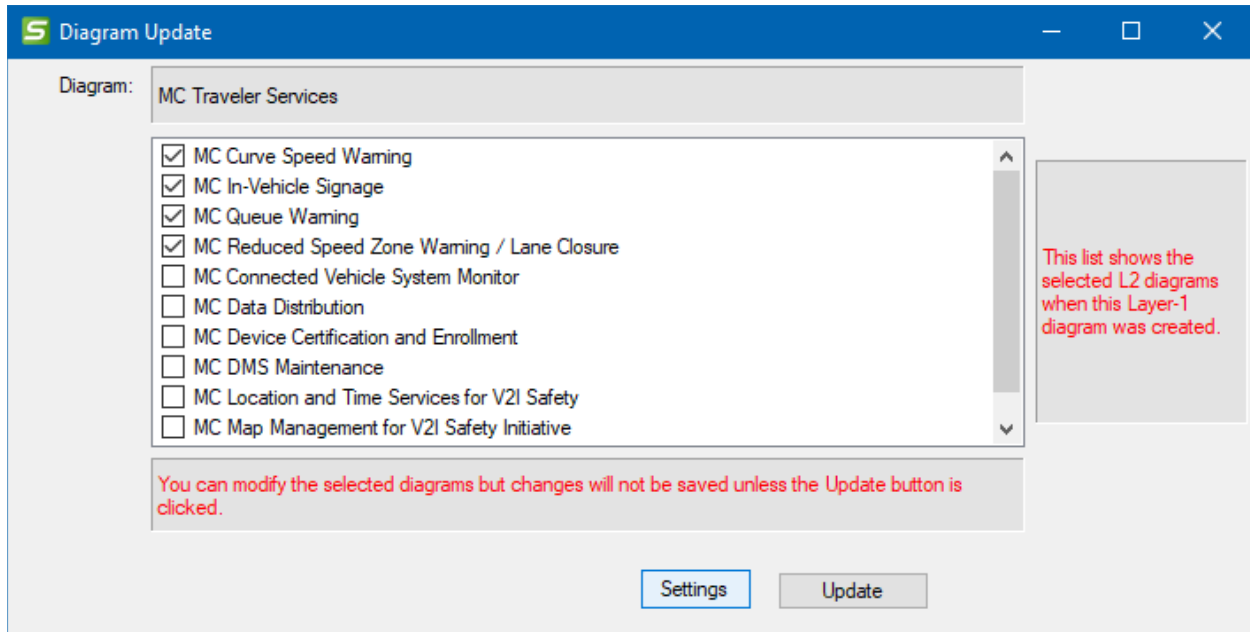

You will see the list of layer 2 diagrams in your architecture and it will check the ones that were used to build the Layer 0 / 1 drawing. There are several ways to use the Diagram Update tool.

- 1) Add new elements (physical objects) onto your project summary diagrams.
- 2) Remove elements no longer included in your project.
- 3) Connect or remove interconnects on the project summary diagrams based on changes made to the lower-level diagrams.
- 4) Add or remove functional objects from the Layer 1.

Select the Layer 2 diagrams you want to be included in your Layer 0/1 diagram or deselect the diagrams you no longer want to be included. Note that you can only include diagrams that have been fully customized, i.e., all the shapes have been assigned an element.

You can also change the Settings used to update the diagram, including how the items are placed, whether to include Flows or Interconnects, etc. See [Layer 0/1 Settings](#) for more information.

If your current diagram is set to show Flows and you change the Settings to draw Interconnects (or vice versa) then SET-IT will warn you that it will need to redraw the whole diagram. This gives you a chance to go back and change the Settings if that isn't what you intended.

When you are done selecting and deselecting the Layer 2 diagrams to include in the Diagram Update process and setting the Settings then click the "Update" button.

This will check for changes to Elements to add/remove, Element names to change, functional objects to add/remove, and interconnects to add/remove or recharacterize based on changes to the underlying layer 2 diagrams. This tool will also be cognizant of Terminals you have used on your Layer 0/1 diagram by removing or renaming them as necessary.

Show Related Shapes

When you are on a physical layer 2 diagram and you bring up Shape Properties for a shape – flow, element/physical object, or a functional object – you can click “Show Related Shapes” and it will highlight the other shapes that are related to that selected shape – requests that go with responses, status flows that go with configuration flows, other elements needed to support a function, etc. This can be really useful on complicated diagrams. If a shape (flow or functional object) doesn’t have any defined relationships between it and other shapes, then this button will just be greyed out.

Update an Enterprise Layer 0 Diagram

The Update Diagram tool lets you update an existing Enterprise layer 0 diagram. This will let you add or remove elements (represented as Resources), stakeholders (represented as Enterprise Objects) or agreements and expectations between the stakeholders from the Layer 0 diagram based on changes to your Physical Layer diagram. This prevents you from having to redraw the entire diagram when you may have made only minimal changes to your project.

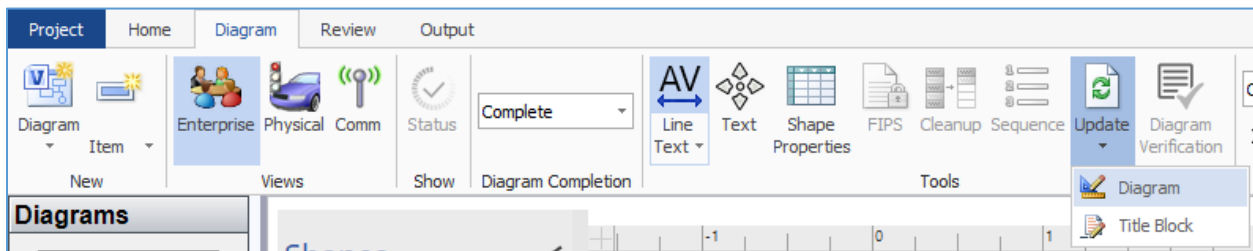

Click the caret under the “Update” button and select “Diagram” to bring up the Update Diagram tool.

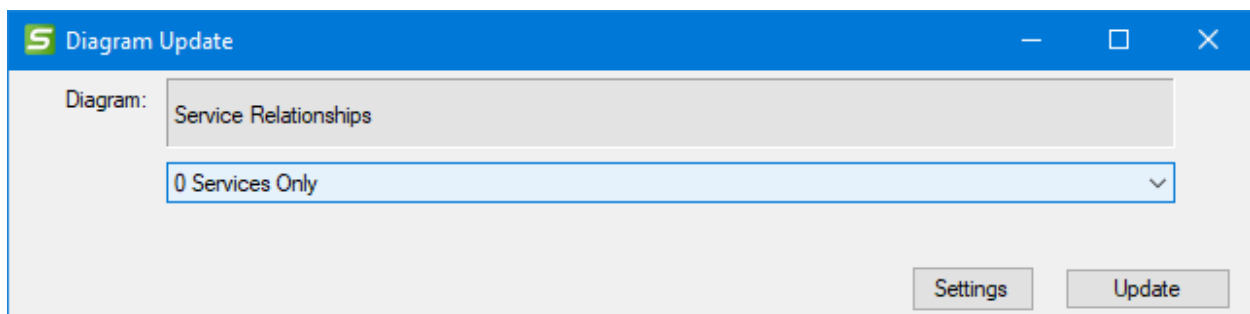

You will see a pull-down list of the physical layer 0 diagrams in your architecture and it will pre-select the one that was used to previously build the Enterprise Layer 0 diagram. If it was created in a previous version, it may not know which physical diagram was used and you will need to select the one that best fits. Usually, your project will only have 1 or a few physical layer 0 diagrams.

Note that you can only include 1 physical diagram upon which to base an enterprise diagram.

Use the Settings button to change what is displayed – Resources, Agreements, Expectations, Roles – and whether or not to Hide the Text.

When you have selected the Physical Layer 0 diagram to include in the Diagram Update process and are satisfied with the Settings then click the "Update" button.

This will check for changes to Elements and Stakeholders to add/remove, Element names to change, agreements and expectations to add/remove or recharacterize based on changes to the supporting physical layer 0 diagram. This will also remove any auto-generated agreements that are considered obsolete, meaning they are no longer supported by stakeholders or flows that may have been previously removed. Any agreements that were created or edited by the user will be retained.

NOTE: If you edit the properties of an element within Enterprise View to change the status of a stakeholder's relationship – say, to change stakeholder that 'owns' a resource from 'project' to 'existing' status; you may see that the role disappears from the diagram. This is normal. When any new mapping is added, removed, or changed in Element Details, the "Update" tool must be run for the new role to be seen on a diagram. Because two roles can only occupy the same line if they have the same status due to line encoding, changing the status of a role can require SET-IT to draw a new role shape which is something we only do when running the Update tool. So, for consistency when the status of a role is changed in the Details form, for example from "Project" to "Future", then SET-IT treats it as if the user deleted the "Project" version of the role then added the "Future" version of the role. Sometimes this will require 2 lines to be drawn if it has one existing role and another project or future role. Run the Update Diagram tool and the roles will be redrawn.

Update the Diagram Title Block

All of the Diagrams in SET-IT include a **Title Block**, the diagrams 'included' from ARC-IT as well as custom created diagrams. The information in the **Title Block** contains basic information about the diagram – name of the service package, whether it came from or is based on ARC-IT, a revision number the date it was created/edited, and by whom.

2: TM04: Connected Vehicle Traffic Signal System (Copy 2)			
1	Based on ARC-IT Physical Diagram TM04 r16	Apr 19 2024	

From the Diagram menu, you can click the caret under the **Update** button and "**Title Block**".

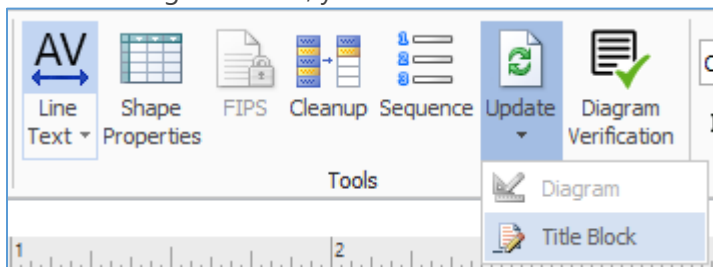

SET-IT will prompt you that this action will increment the version number (assumes you are using numbers to describe your versions), update the date to today's date, and update the Initials in the lower right box to match the initials, if any, that are in the Overview / Project window. You have a chance to say **Yes** to continue or **No** to leave it the way it is.

You can turn off these reminders with the **Checkbox**.

NOTE: If you make changes to the Project Overview information such as the initials of the developer or maintainer those would only be changed on the diagram when you click the **Update Title Block** button described above.

You can also edit the name of a diagram by editing the name in the Left Menu. Right-click while hovering over the name of one of the diagrams in the left menu and click Rename.

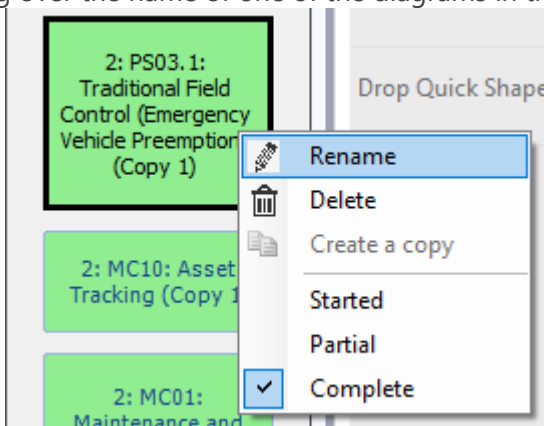

This will open the Diagram Rename dialog box.

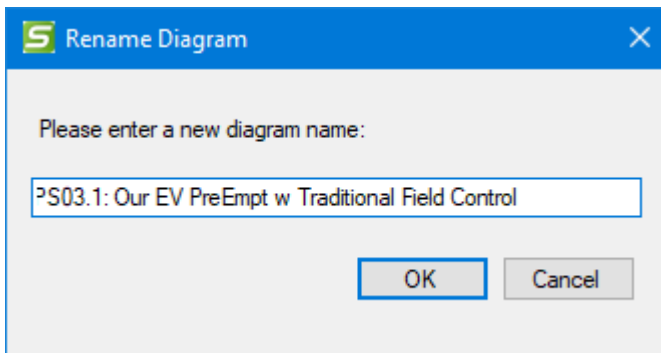

Edit the name and click OK. SET-IT will then update the name in the title block.

Pan and Zoom a Diagram

For diagrams that get larger than will fit onto your screen, use the **Zoom** feature from the Diagrams menu. The Zoom area has 2 choices

- Clicking the **Zoom** button launches the "Pan & Zoom" box (a small pop-up window that shows a snapshot of the entire diagram) to let you use your mouse to draw a box around the

area of the diagram you want to zoom in on. You can also click and drag the red highlight box to pan around the diagram to focus on different areas.

- Clicking the **To Page** button is a short cut to quickly change to magnification so that the entire diagram fits within the diagram area of the SET-IT window.

Defining Scenarios

Being able to document scenarios is a useful way to build a good Concept of Operations for your project. Here is how the FHWA Systems Engineering Guidebook (at <https://www.fhwa.dot.gov/cadiv/segb/>) describes Scenarios as part of a ConOps:

This is the heart of the document. Each scenario describes a sequence of events, activities carried out by the user, the system, and the environment. It specifies what triggers the sequence, who or what performs each step, when communications occur and to whom or what [e.g., a log file], and what information is being communicated. The scenarios will need to cover all normal conditions, stress conditions, failure events, maintenance, and anomalies and exceptions. There are many ways for presenting scenarios, but the important thing is that each stakeholder can clearly see what his expected role is to be.

In SET-IT you can define Scenarios that include one or more Sequences of steps and map those to Service Package diagrams.

Create a Scenario by using the Scenarios grid on the Definitions menu. Click the row with the asterisk (*) and start filling in the Name, an Order in which to list the scenarios in the document, and a Description of the scenario.

Definitions		
Scenarios		
Name	Order	Description
In-Vehicle Signage Normal Operations	1	This scenario is the normal set of sequences and activities required to operate an in-vehicle signage service.

Another way to define a Scenario is to start by defining a Sequence on a diagram first. See *Defining Sequences* below.

In a Concept of Operations, a scenario is used to describe how the system will be operated under various conditions. For example, incident management scenarios will include normal monitoring, the sequence of events following an incident, and response to failure [e.g., sensors or communications]. In other Service Packages you might want to describe a 'sunny day' scenario and contrast that with the activities that take place in a 'rainy day' scenario. These scenarios should describe the activities from the viewpoint of each of the participants.

Defining Sequences

Another tool on the Physical view Diagrams menu allows you to create sequences of events by attributing step numbers to flows or shapes on a physical diagram. Use the Definitions menu to

create a *Scenario* and one or more *Sequences* that are to be assigned to a particular diagram. Once those are created select the diagram you want to work with and press the Sequence button at the top of the screen.

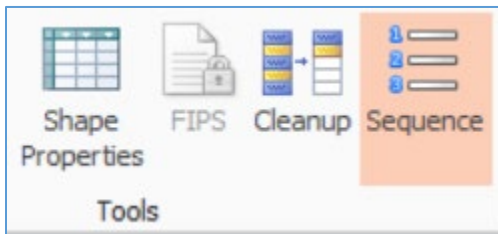

On the Sequence Tool window click the Pull-down for the Sequence name as shown below:

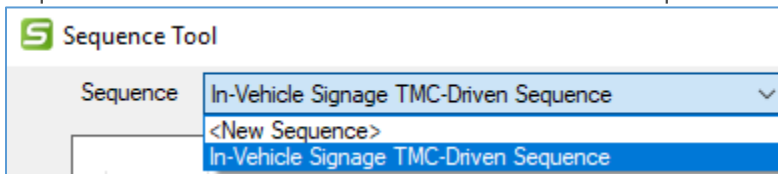

From the pull-down, select an existing sequence or create a new one by selecting <New Sequence>.

The image shows the 'New Sequence' form. It has a title bar with a green 'S' icon and the text 'New Sequence'. The form contains the following fields and controls:

- Name:** A text box containing 'Specialty Vehicle In-Vehicle Signage'.
- Description:** A text area with 'Auto-Populate' on the left and a scrollable description: 'In addition to having in-vehicle signage messages broadcast from roadside equipment under some center's control, Marinara County may also have transit vehicles equipped with the ability to broadcast messages to surrounding vehicles with information such as turning actions, route info, or wide area alerts.'
- Scenario:** A pull-down menu.
- Diagram:** A pull-down menu containing 'In-Vehicle Signage'.
- Order:** A numeric spinner box set to '0'.
- Style:** A pull-down menu set to 'Black'.
- Hyperlink:** A label next to the Order and Style fields.
- Buttons:** 'OK' and 'Cancel' buttons at the bottom right.
- Footer:** 'Form Source: Form Sequence' at the bottom left.

The New Sequence form includes fields for Name and Description and then controls for assigning the Scenario, the diagram (will default to the diagram you are currently on), the order in which this will appear in the ConOps relative to the other Sequences for this diagram, and the Style of the circles to use.

Click the Scenario pull-down to assign this sequence to a New or existing Scenario.

S New Sequence

Name: Specialty Vehicle In-Vehicle Signage

Description: In addition to having in-vehicle signage messages broadcast from roads Marinara County may also have transit vehicles equipped with the ability vehicles with information such as turning actions, route info, or wide area

Scenario: <New Scenario>

Diagram: In-Vehicle Signage Normal Operations

Clicking <New Scenario> will launch the Scenarios form in a new window. See *Defining Scenarios* above for more information about scenarios.

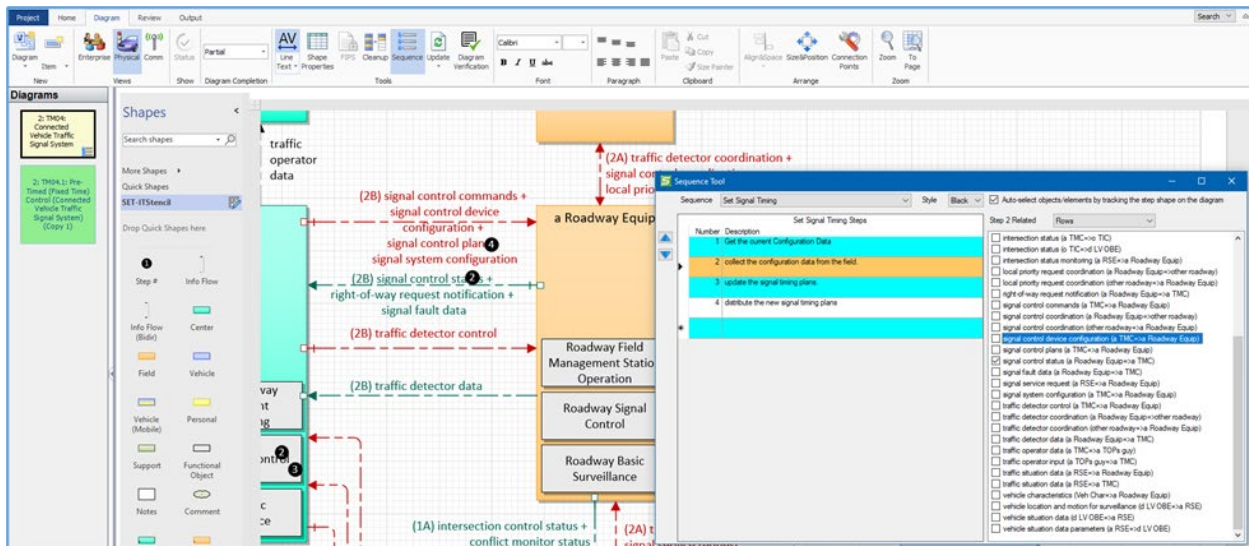

The Sequence tool provides a list of steps, the sequence, the style/color, and the related flows or objects with which each step will be associated.

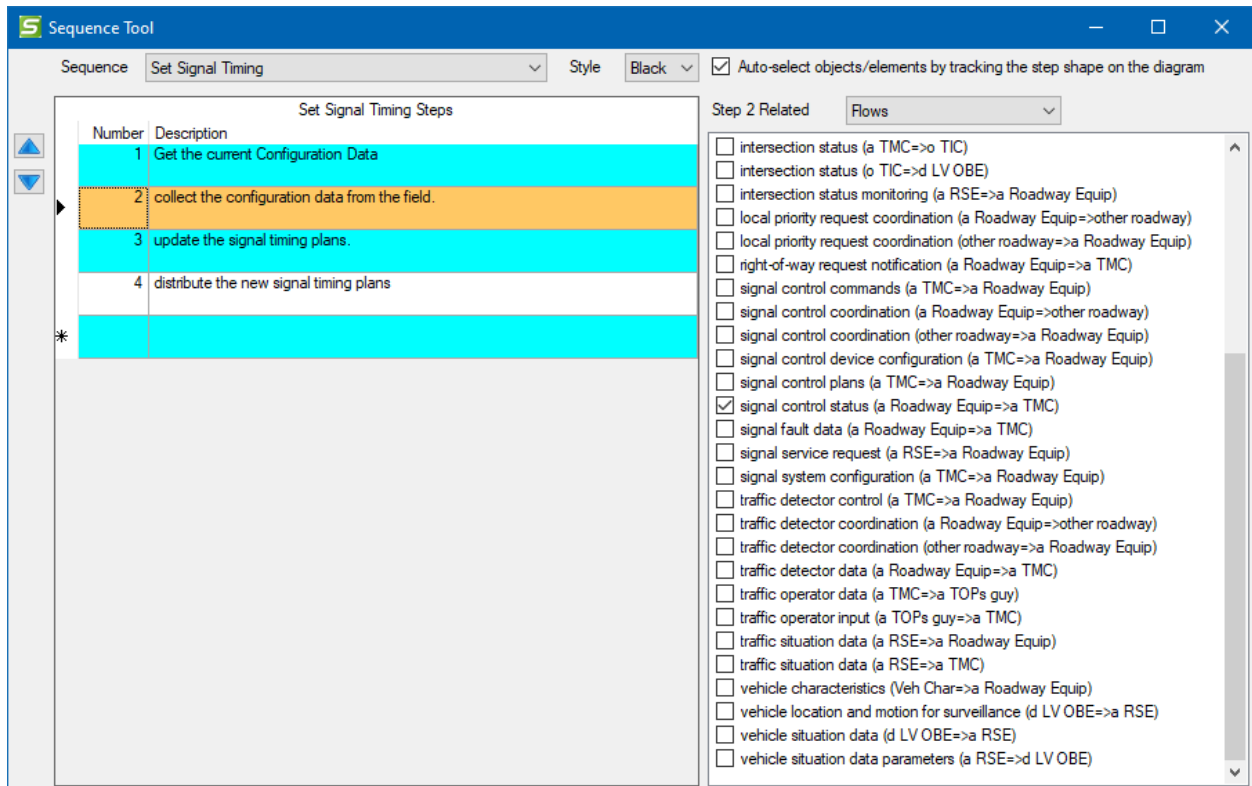

If there is more than one sequence that pertains to a diagram use the Sequence pull-down at the top to switch between sequences.

If you need to create a new sequence, you can go to the Definitions menu and use the Sequence grid or you can use the pull-down here and select <New Sequence>. From there you can give the sequence a name, a description, a style (color), and order. You can also select a scenario or create one and you can relate the sequence to a diagram.

When you selected the Sequence Tool the stencil added a Step icon.

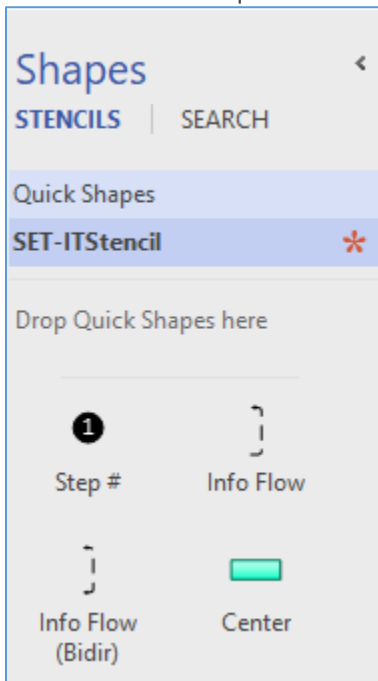

You can put step #s onto the drawing by highlighting the step on the Sequence Tool window then clicking and dragging the Step # onto the drawing surface. It will automatically color it based on the Style selected and will be numbered based on the row you highlighted in the Sequence Tool window.

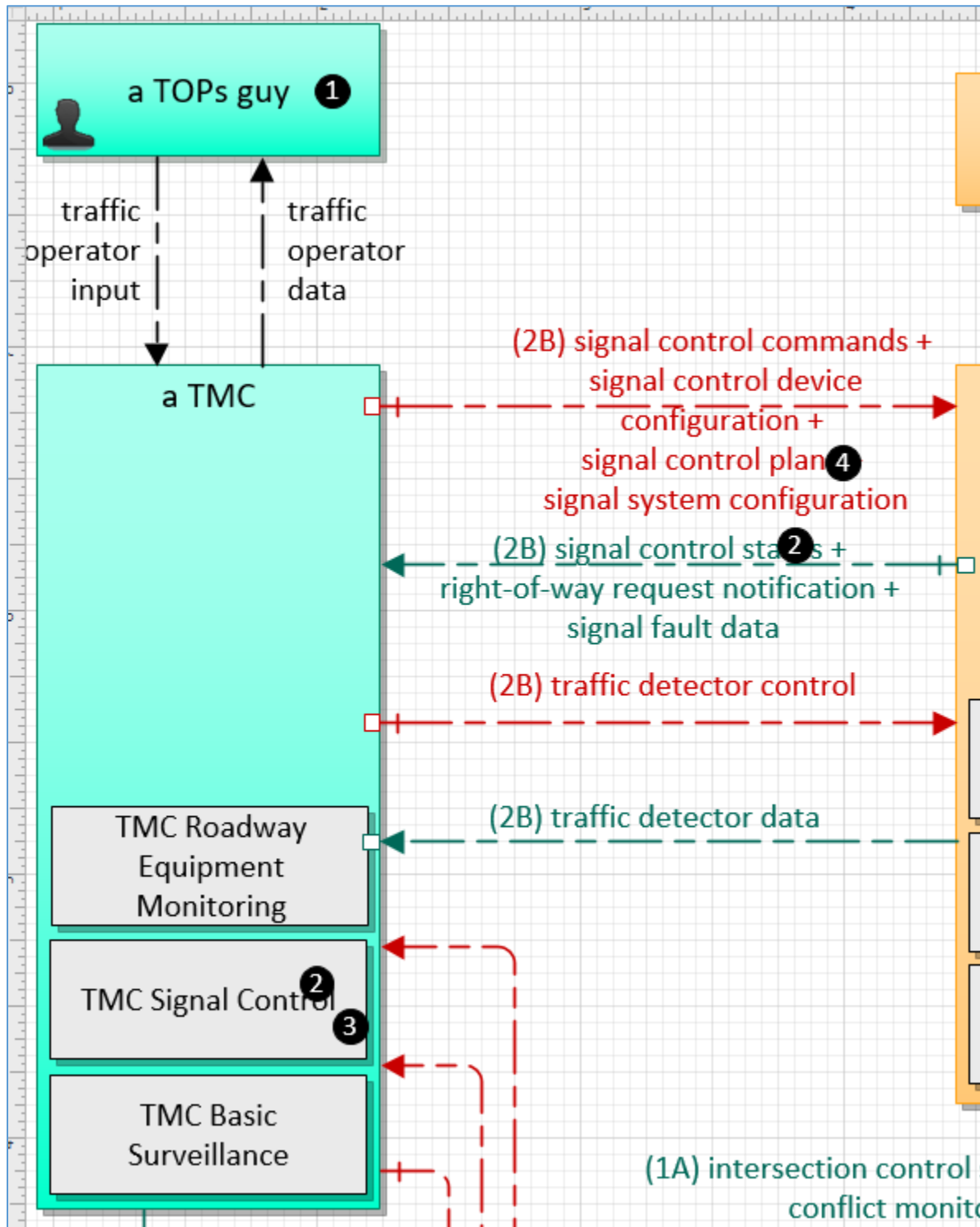

The Sequence Tool window has a checkbox at the top-right that says "Auto-select objects/elements by tracking the step shape on the diagram." With that checked, notice the Sequence window changes as shapes are dragged onto the drawing. The Sequence tool will also automatically map the step number to the object on the diagram. For instance, if you drag the step shape over an Element

you will see the Sequence tool associate that step with that element. You can also do this for Information Flows or Functional Objects (the smaller boxes of functionality within the Elements).

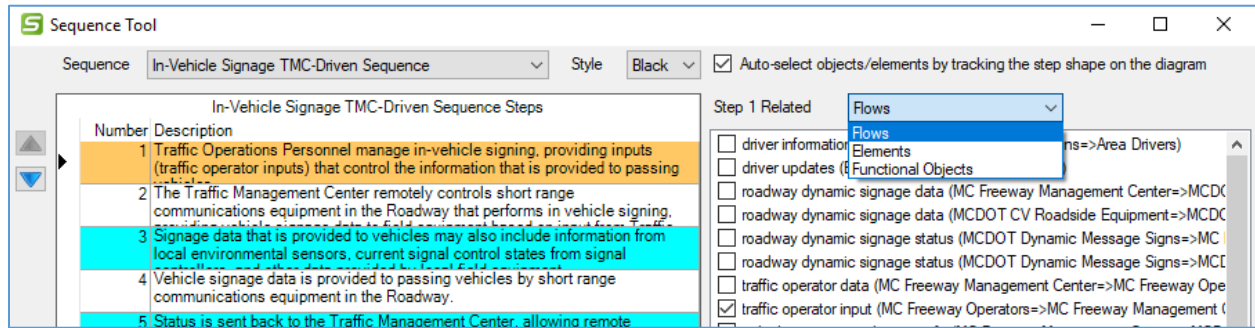

NOTE: As you drag a step onto the drawing this process will map the step to last thing (flow, element, functional object) you placed the step over. You can drag a step shape over multiple things but if you drag it over multiple flows, it will only map it to the last flow. The work around is to select the extra flows using the checkboxes in the Sequence Tool window.

The Sequence numbers are on a separate *layer* from the rest of the diagram so when you close the Sequence Tool window the numbers will disappear, too. Select Sequence button again to bring them back.

The ConOps document – see [Output Documents](#) section – can include the scenarios and the diagrams with the sequences shown on them.

Clipboard

The Clipboard is available from any of the left-menu choices. It provides the basic **cut**, **copy**, and **paste** functions that you're used to in other graphical programs.

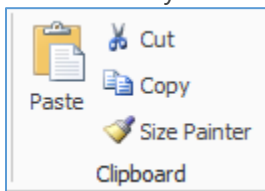

One unique feature with SET-IT is on the Diagrams page. You can use the **Size Painter** to copy the size of one physical object and make another object have the same size. This may be useful when trying to make sure similar objects appear to be the same size/shape.

NOTE: Copy and Paste can be done on a Layer 2 diagram for functional objects, for instance to copy a functional object from one element to another similar element on that diagram. You may notice that the functional object shape is blank after pasting. That happens when you paste the functional object into another class shape, i.e., you paste a field functional object into a center element.

Editing/Adjusting Your Diagrams

There are other features on the Diagrams window that you can use to make your project diagrams look the way you would like.

- **Font:** this is used to change the font or type face used for labels on the shapes on your diagram. Select a flow or object and use the font and size pull-downs to change the appearance of that flow or object. You can also set whether to use Bold, underline, or cross-outs. SET-IT reserves the use of italics for objects, flows, or agreements that haven't been customized yet.

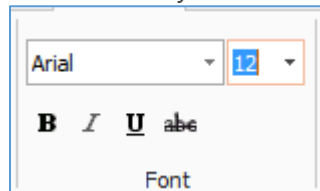

- **Paragraph:** You can use the Paragraph tools to change the way a group of text appears. Again, highlight the text to be modified and select whether the text labels in an object should be centered at the top, middle, or bottom of the object. You can also decide whether the paragraph contents should be left-, center-, or right-aligned or justified to fit within the margins of the object or flow boundaries.

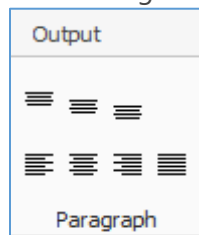

- **Tools**
 - **Line Text / Text Tool:** This button has multiple controls.

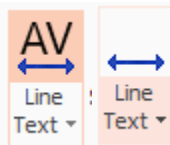

Clicking the AV button with the line underneath it will automatically Show or Hide the text of all of the flows on the diagram. The default on Layer 0 and Layer 1 diagrams is to hide the text. These diagrams are usually considered high-level summaries of a project and the text of the interconnects is often not necessary. The default on Enterprise and Physical Layer 2 diagrams is to show the text. When you click the Show/Hide button the AV will disappear to indicate that the text is now hidden. Click it again and the text will reappear.

The other use of the tool is to Select a flow, click the downward pointing caret and select the Text Tool.

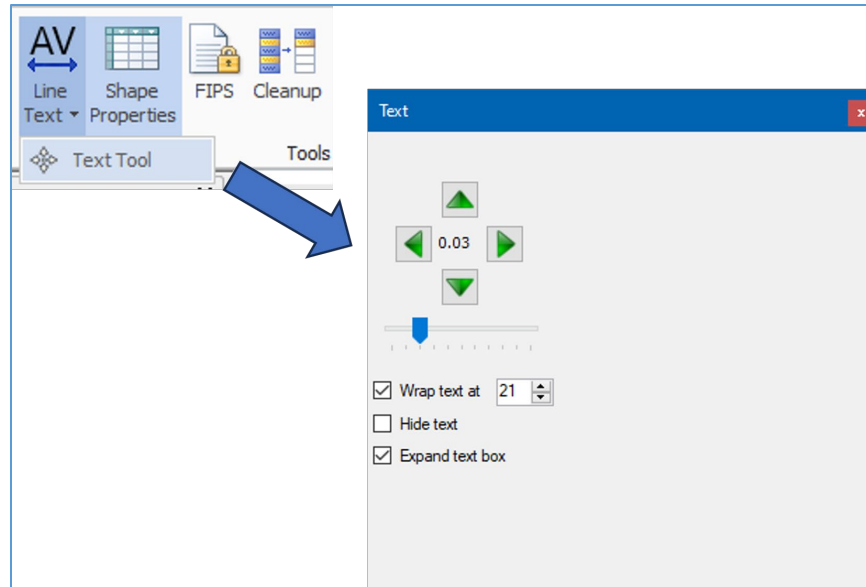

Now you can use the up, down, left, and right arrow buttons to 'nudge' the text around. Use the slider bar to control how far each button push will move the text. The numbers in the center of the arrows indicate the distance each click will nudge the text, from 0.01 to 0.64 inches. (**Hint:** it seems that 0.05 is enough to move a text line from the middle of the line to sit just above the line).

This window is also used to select whether the text should **Wrap** and at what point, i.e., how many characters per line.

Another checkbox here allows you to "Hide" the text label completely. This is handy if you have flows coming from one source and going to multiple destinations and they all have the same characteristics. This can make the diagram look cleaner if you line up the flows on top of each other and just use one label. This gives the diagram a look similar to an electrical schematic.

TIP: Only use the "Hide text" option when all of the flow characteristics are the same. If a particular triple (source, destination, flow name combination) has a unique characteristic then it should be seen separately from the other flows on the diagram.

The text labels sometimes have default widths to them and changing the wrap value may not have the affect you expect. Click the "Expand text box" box and that will put the flow or agreement name on one line. Now you can use the Wrap values to more effectively change your diagrams.

NOTE: The Text or Nudge tool will be 'floating' when it first opens. You can 'dock' it by clicking the title of the box then drag and 'drop' over the icon that looks like a closed door on the right or left side of the screen. To undock it click the title of the box and drag it to another area of your screen. This may be helpful if you want to put the nudge arrows right next to the text you are trying to edit.

You can also simply close the Text tool by clicking the X button in the top right of the window.



- **Sequence:** See [Defining Sequences](#) above.
- **Arrange:** The Arrange area of the Diagrams toolbar allows the user to access 3 tools: Align & Space, Size & Position, and Connection Points.

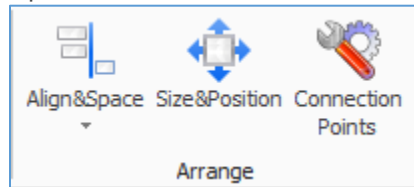

- **Align&Space** allows you to select more than one shape and make them line up a certain way (top, bottom, right, left, center) or to space them apart evenly.
 - An alternative way to line up different objects/boxes is to select one box and drag it around the diagram. As you approach another object you will notice thin lines appear showing how close you are to the center line or top/bottom/left/right edge of the other box.
 - **NOTE:** the Align&Space tool is using features of Microsoft Visio. One of the aspects of Visio's align and space tool is that it is dependent on what is selected first. That will dictate how the other shapes will be aligned. If you pick 3 shapes and choose Center, then it will line the shapes up to the first shape picked.
 - **NOTE:** The other thing to note is that Align&Space does not work well when you use a 'lasso' technique to select multiple objects. When you click the mouse and drag a square around several shapes to select them all at once Visio cannot determine which was selected first in order for its alignment rules to work. To select multiple shapes, it is best to click the first shape and then press the Ctrl button and Left-Click to select the other shapes you want to align.
- **Size&Position** allows you to make fine adjustments to the size and position of an element or object – this also becomes very useful on complicated drawings where you need to adjust just one thing at a time.

Size and Position		
X	<input type="text" value="3.18125"/>	in.
Y	<input type="text" value="3.375"/>	in.
Width	<input type="text" value="1.3"/>	in.
Height	<input type="text" value="1.4"/>	in.
Angle	<input type="text" value="0"/>	deg.

Size and Position

- **Connection Points** allows you to let SET-IT realign the connection points around an object. Connection Points are the places around a shape where you attach connecting lines, e.g., information flows on a physical Layer 2 diagram or a Relationship on an enterprise diagram. This can be very helpful after resizing a shape and the connection points get distributed unevenly. Select a shape and click on the Connection Points button shown above.

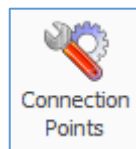

NOTE: some users may find that some shapes have connection points in places other than the boundary of the object. In that case, use this Connection Points tool to redraw them around the object in the right places.

- **Zoom** provides the user with two tools to adjust the screen view:
 - **Zoom** brings up the Pan&Zoom mini-window and you can click and drag to select a subset of the drawing to fill the screen.
 - **To Page** automatically resizes the window to fit the screen.

Other Toolbar and SET-IT tools

- **Project / Options** – From the Project ribbon and the Options menu there is an option that enables delete confirmation for any object deletion.
- **Undo & Redo** – as with most windows-based software you can use the Undo and Redo buttons at the top of the window to back out of a change (undo) or to repeat (redo) a change that you just undid. There may be a difference in behavior between actions that were done on the Visio drawing space and actions done on the definitions and data driven forms. Ctrl-z is also a way to “Undo” an action.

The Quick Access Toolbar (QAT) is a feature common to many Windows applications. It appears at the very top of the SET-IT window. In SET-IT, you can use the pull-down menu at the right of the QAT to change what appears at the top:

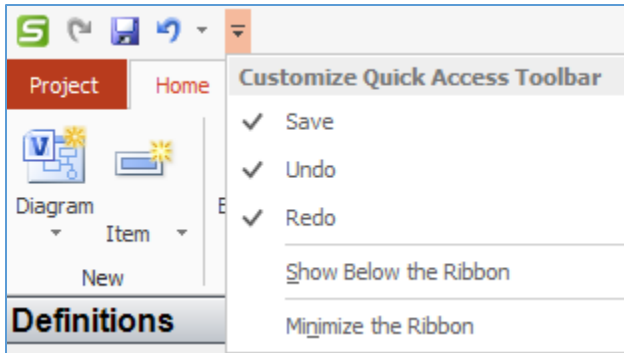

Using Terminals

Terminals are the little rounded rectangles that appear on some of the complicated SET-IT diagrams to reduce some of the clutter caused by having too many lines crossing each other or when the same type of interface needs to go to multiple places, e.g., from a data warehouse to all of the traffic centers in the area.

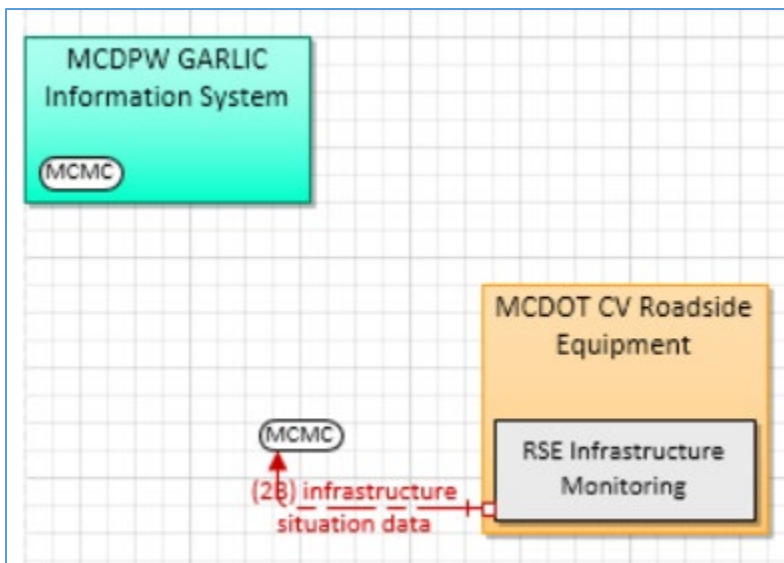

Rather than drawing lines all over the page – either crisscrossing over many existing lines or wrapping all around the side of the drawing using a terminal allows you to show how lines may start at one point and end up at another part of the drawing.

Adding Terminals

To add a terminal to a drawing:

1. Drag a **Terminal** from the stencil and drop it inside a physical object. This will create a new shape and associate it with the element that it is in. SET-IT will give the terminal an abbreviation based on the name of the element.

CAUTION: Only 4 or 5 characters can fit in a Terminal shape so you may need to edit the abbreviation of the Element in the Element Details window to make sure the Abbreviation makes sense. A default abbreviation will be entered in the Abbreviation box but you can

change this to something that makes more sense to your stakeholders. If your name is more than 5 words long, it will stop after 5 characters. If the automatic abbreviation will cause a conflict with an existing abbreviation, then the last letter will be replaced by a number.

2. To create the other side of the interface, drag and drop another terminal from the stencil and drop it inside the same physical object. This will create a new shape and associate it with the element. Then drag that new terminal to be near a physical object on another part of the drawing.
3. Now to add flows, instead of drawing them all the way across the drawing between the physical objects you can use the terminals. Draw lines from the physical objects from step 2 to the terminal.
4. When you use Shape Properties to tell SET-IT what information flows to include on that line it will show the flows that can go between the physical object in step 1 and the physical object in step 2 as if they were directly connected.

NOTE: With Terminals you only have to name the flows on one side of the interface.

Going Further with Terminals

As you go on to build your higher layer drawings SET-IT will consider any flows that were routed using terminals on Layer 2. One thing that SET-IT doesn't do is assume that because you had terminals on a layer 2 drawing that you will want terminals on Layer 0 or 1. It will just draw the interconnects directly between the source and destination.

If you notice that your Layer 1 or Layer 0 drawings are too crowded you can use Terminals manually on Layer 0 or 1 the same way you did on the Layer 2 drawing, except with physical interconnects.

Using Data Distribution

In a traditional ITS environment, most information exchanges are performed between systems owned, operated, and managed by the same party. Often these interfaces are built as part of a project initiated by that party and managed by an integrator to ensure the necessary functionality and data exchanges work properly.

Recent developments in connected and automated vehicle systems suggest a new paradigm, where the producers of the data do not necessarily have a direct relationship with the consumers of that data. Similar developments beyond ITS where data is shared between business units to produce new performance analytics or inform decision making further suggest expanding the number and types of parties that might want access to ITS or Cooperative ITS (C-ITS) data. Both of these trends benefit from more ubiquitous, project-agnostic means for providing, discovering, and acquiring data. This is where data distribution fits in.

Data distribution functionality allows application processes (i.e., ARC-IT functional objects) to request information from (subscribe) and offer information to (publish) the communication network to which

they are attached without needing to know anything about the details of how the information transfers take place. Using metadata and service configuration requests, a variety of policies, rules and regulations can be implemented. Thus, applications will not need to directly create and consume messages with other applications to affect information exchange. Instead, they can publish data they agree to share (and receive data they are interested in) through an Application Programming Interface (API) without having to know anything about the final destination(s) (or source) or having to conform to a particular message format for each end entity.

There are many technical solutions to implementing data distribution functionality, but they all boil down to the use of some middleware that sits between the application and the communications stack. Some data distribution implementations require a centralized distribution facility (aka, a broker), while some integrate the broker functionality into the middleware. Both approaches have merits and applicability, the discussion of which is beyond the scope of this help file.

SET-IT includes communications solutions based on four data distribution protocols included in ARC-IT:

- Apache Kafka, a distributed streaming platform that enables publish and subscribe (pub-sub) on streams of records, similar to a message queue or enterprise messaging system. Kafka requires a centralized broker, stores streams in a fault-tolerant durable way and processes streams of records as they occur.
- Organization for the Advancement of Structured Information Systems (OASIS) Advanced Message Queuing Protocol (AMQP), a symmetric peer-to-peer protocol operating over TCP/IP that enables the development of clients, brokers, and routers. A given node can operate as client and broker, or simply as server. In this way AMQP can support hub-spoke, peer-peer, and hierarchical hub-spoke architectures. AMQP works with Transport Layer Security (TLS) and enables pub-sub through filters at brokers/routers. In practice, AMQP implementations mostly operate as a hub-based protocol.
- OASIS Message Queue Telemetry Transport (MQTT), a pub-sub protocol designed for a hub-spoke architecture pattern where data providers tend to be low power, low-capacity devices. Compared to the other protocols it is relatively lightweight and simple to implement.
- Open Management Group (OMG) DDS, a pub-sub protocol that does not use a centralized hub at all. Instead, each data producer is also a data publisher. Architecturally, OMG DDS follows the peer-to-peer model. OMG DDS' requirements on the data provider/publisher communicate directly with subscribers necessitates a discovery phase, where OMG DDS-enabled entities establish communications. This discovery phase is contained within the base specification but is often extended by vendors.

By using data distribution systems, ITS deployments can avoid silos and make data available to more users with less work to define specifications or establish agreements. This applies even more so to connected vehicles and cooperative ITS applications. For instance, connected vehicles may be broadcasting situational data that may be picked up by roadside infrastructure. Individual drivers do not sign agreements with every roadside equipment owner/operator – they are all part of the trusted connected vehicle environment. Once that data is collected by the infrastructure it can be used in a number of ways – not necessarily by the same agencies and not necessarily for the same things. A traffic agency may want that data to understand traffic flow but a maintenance department may be

able to use the same data to plan where to deploy their maintenance fleet. The data distribution concept allows interfaces to be setup such that developers can take advantage of these supporting systems that worry about the data distribution mechanics and the developers can focus on the transportation needs being addressed.

These 'clearinghouses' of data make it possible for one agency or entity to establish a set of data collectors that then make the data available to any number of agencies that register and subscribe to the data they need.

Another idea is that a data warehouse could be used to drive the output of the data to mobile consumers of data – the travelers. Multiple agencies may have data that they want to get out to the traveling public but don't want to maintain the technology to broadcast data in all the media that the connected vehicle environment and today's wireless communications make possible. These application providers can establish a relationship with a centralized data warehouse that will then make the data available to its mobile subscribers. This data warehouse will maintain the data and maintain the trust and security for how that data is to be distributed.

So how do you show Data Distribution in SET-IT?

1. From the New/Item/Element window – you can define one or more Data Distribution systems. These are of the Communications domain / Support class of physical objects.
2. On Layer 2 – the service package specific diagrams – you can assign a flow characteristic to a transportation related information flow to say that this flow will go through a data distribution system using the "DDS" pull-down on Shape Properties.
3. Build a Layer 1 or Layer 0 drawing. SET-IT will show the flows routing through the Data Distribution system defined in step 1 and selected in step 2.
4. On the Information Flow Triples grid, you can use the pull-downs in the DDS column to select a Data Distribution System element for a flow if it is eligible. You have to have created a DDS element first.
5. When you create user defined flows you can assign it to be DDEligible – or eligible for routing through a Data Distribution System.

NOTE: According to ARC-IT, not every information flow is eligible for routing through a data distribution system. Some flows like information broadcast from a single source to many destinations at once might use a Wide Area Information Distribution mechanism but not something like a data warehouse or clearinghouse. In other cases, the information may be transactional in nature, meaning that it really needs to be seen and used by the receiver like traffic signal control commands. In those situations, the *DDS* pull-down will be greyed-out and unavailable.

Note that in most cases, you do not need to include SU03 Data Distribution. When you get the communications view, you will see that OMG DDS is available for every flow that is DD-eligible. For the other protocols, creating a data distribution system as noted in step 1 above will be enough to enable Apache, MQTT and AMQP solutions, as that element serves as the hub or broker for the chosen protocol.

Needs

One of the critical early steps in a Systems Engineering process for a project is to establish the Needs of the system and its users.

The Needs are designed to answer two basic questions:

- What does the System need to do?
- What do users need from the System?

ARC-IT was developed by extracting needs from a variety of sources including other Concepts of Operations documents for ITS and connected vehicle research projects. These source needs are used as starting points for your own project architecture.

Use the Definitions menu (on the bottom left side of the window) with the Physical view selected at the top to add and edit your needs. There are 2 Needs related buttons:

- **Need Areas** – an area is created for each service package.
- **Needs** – statements that describe functionality or capability that is necessary for a service to be provided by an ITS project.

You may also import Needs from one of the FHWA Model Systems Engineering Documents. Use Requirements Options to change the source of your project to use one of the Model Systems Engineering (SE) documents published by FHWA then select one of the services for which the model documents were based. SET-IT will import the needs and requirements associated with the model document in place of the ARC-IT needs and requirements written for that service package.

The table below shows which services are connected to the model documents.

SP Identifier	Service Package (SP) Name	SP Implementation	Model SE Document
TM01.1	Infrastructure Based Traffic Surveillance	Detector Based Surveillance	Traffic Sensing and Detection Systems (TSDS)
TM01.2	Infrastructure Based Traffic Surveillance	Video Monitoring	Closed Circuit Television (CCTV) Systems
TM03	Traffic Signal Control		Central Traffic Signal Systems
TM06.1	Traffic Information Dissemination	Dynamic Message Signs	Dynamic Message Sign (DMS) Systems

NOTE: More than one copy of a model document cannot be added to the same project. You will get a warning message to that effect if you try to include a 2nd copy of one of the service packages listed above.

Need Areas Definitions Grid

A *Need Area* is just a way to organize and introduce the needs. Initially these are based on the service packages, but you can create your own.

Need Areas				
Order	Name /	Description	Associated Service Package Instance	Type
0	SU01: Connected Vehicle System	This service package provides monitoring,	MC Connected Vehicle System Monitor	Support
5	SU03: Data Distribution	This service package manages the distribution	MC Data Distribution	Support
0	SU04: Map Management with	This service package defines interfaces that can	MC Map Management for V2I Safety Initiative	Support
3	SU05: Marina Location and Time	This service package identifies the external	MC Location and Time Services for V2I Safety	Support
0	SU08: Security and Credentials	This service package is used to ensure trusted	MC Security and Credentials Management	Support
4	SU09: Device Certification and	This service package is used to illustrate the	MC Device Certification and Enrollment	Support

Use the Definitions grid to add or edit the names and descriptions for the Need Area.

- The Name and Description columns can be edited to personalize the need areas for your project documentation.
- The Associated Service Package Instance column indicates which service package the Need Area is associated with or if it is a general area.
- The Type column indicates the type of service package this need area is from – Safety, mobility, etc. The Type could also be set to <Unspecified> for a set of needs that may not be tied to any particular type of service packages.
- The Source column indicates the source used to derive the needs. This will typically say ARC-IT or one of the Model Systems Engineering documents depending on the Requirements Options settings.

In the ConOps, these Need Area descriptions will be used as the introductory paragraph for the Needs tables.

Needs Definition Grid

The *Needs* button opens a table or grid to show the needs that have been imported for each of the ARC-IT service packages you included as well as new or user defined needs you created.

Needs									
Need Area	Need #	Need	Priority	Applicable	Info Only	Comment	User Defined	More...	
SU01: Connected Vehicle System Monitor	01	Maintenance personnel and system operators need to be able to track and manage the configuration	Medium	<input checked="" type="checkbox"/>	<input type="checkbox"/>		<input type="checkbox"/>	Details	
	02	System operators and maintenance personnel need to be able to detect, isolate and correct	Medium	<input checked="" type="checkbox"/>	<input type="checkbox"/>		<input type="checkbox"/>	Details	
	03	System operators need to be able to monitor the performance of equipment providing ITS services.	Medium	<input checked="" type="checkbox"/>	<input type="checkbox"/>		<input type="checkbox"/>	Details	
SU03: Data Distribution (Copy 1)	04	System operators need to be able to monitor the physical security and cybersecurity of equipment	Medium	<input checked="" type="checkbox"/>	<input type="checkbox"/>		<input type="checkbox"/>	Details	
	01	System Operators, Vehicle Operators, and PID Operators need to be able to request and receive	Medium	<input checked="" type="checkbox"/>	<input type="checkbox"/>		<input type="checkbox"/>	Details	
	02	System Operators need to be able to provide data to a geographically selected area.	Medium	<input checked="" type="checkbox"/>	<input type="checkbox"/>		<input type="checkbox"/>	Details	
	03	Data Distribution Operators need to be able to exchange data with other data distribution systems.	Medium	<input checked="" type="checkbox"/>	<input type="checkbox"/>		<input type="checkbox"/>	Details	
SU04: Map Management with Connected Vehicles	04	Data Distribution Operators need to be able to establish and maintain data processing algorithms, rules	Medium	<input checked="" type="checkbox"/>	<input type="checkbox"/>		<input type="checkbox"/>	Details	
	01	System operators, vehicle operators and PID users need map data that is accurate and consistent	Medium	<input checked="" type="checkbox"/>	<input type="checkbox"/>		<input type="checkbox"/>	Details	
	02	Mapping operators need real-world observations of roadway geometry, intersection geometry and	Medium	<input checked="" type="checkbox"/>	<input type="checkbox"/>		<input type="checkbox"/>	Details	
SU05: Marina Location and Time Services	03	Mapping operators need to be able to exchange mapping information (map data and update	Medium	<input checked="" type="checkbox"/>	<input type="checkbox"/>		<input type="checkbox"/>	Details	
	01	System operators, vehicle operators, support system operators, PID users, maintenance personnel	Medium	<input checked="" type="checkbox"/>	<input type="checkbox"/>		<input type="checkbox"/>	Details	
	02	Vehicle Operators, PID users and system operators need their devices to operate from a common	Medium	<input checked="" type="checkbox"/>	<input type="checkbox"/>		<input type="checkbox"/>	Details	
SU08: Security and Credentials Management	03	Vehicle Operators and PID users need their vehicles and devices to determine their current location.	Medium	<input checked="" type="checkbox"/>	<input type="checkbox"/>		<input type="checkbox"/>	Details	
	01	The CCMS Operator needs to grant trust credentials to qualified end entities including mobile devices	Not Applicable	<input type="checkbox"/>	<input type="checkbox"/>		<input type="checkbox"/>	Details	
	02	The CCMS Operator needs to be able to revoke the credentials it distributes, so that a misbehavior or	Not Applicable	<input type="checkbox"/>	<input type="checkbox"/>		<input type="checkbox"/>	Details	
	03	The CCMS Operator needs to secure the exchange of trust credentials between itself and its intended	Not Applicable	<input type="checkbox"/>	<input type="checkbox"/>		<input type="checkbox"/>	Details	
	04	The CCMS Operator needs its systems to be constructed in such a way that the cooperation of at least	Not Applicable	<input type="checkbox"/>	<input type="checkbox"/>		<input type="checkbox"/>	Details	
	05	The CCMS Operator needs its systems to be constructed in such a way that the cooperation of at least	Not Applicable	<input type="checkbox"/>	<input type="checkbox"/>		<input type="checkbox"/>	Details	
SU09: Device Certification and Enrollment (Copy 1)	06	The CCMS Operator needs to accept misbehavior reports from users, so that malfunctioning and	Not Applicable	<input type="checkbox"/>	<input type="checkbox"/>		<input type="checkbox"/>	Details	
	08	ITS Object operators need to be able to authenticate messages received so that they can determine if	Medium	<input checked="" type="checkbox"/>	<input type="checkbox"/>		<input type="checkbox"/>	Details	
	09	ITS Object operators need to be able to determine the privileges a message sender is entitled to so	Medium	<input checked="" type="checkbox"/>	<input type="checkbox"/>		<input type="checkbox"/>	Details	
	10	ITS Object operators need to be able to communicate with other users in such a way as to make it	Medium	<input checked="" type="checkbox"/>	<input type="checkbox"/>		<input type="checkbox"/>	Details	
	11	ITS Object operators need to be able to exchange messages in a secure fashion, so that no other	Medium	<input checked="" type="checkbox"/>	<input type="checkbox"/>		<input type="checkbox"/>	Details	
SU11: DMS Maintenance	11	ITS Object operators need to be able to exchange messages within the regulatory bounds of the	Medium	<input checked="" type="checkbox"/>	<input type="checkbox"/>		<input type="checkbox"/>	Details	
	01	The CCMS Operator needs to provide a mechanism for a user without credentials to request	Medium	<input checked="" type="checkbox"/>	<input type="checkbox"/>		<input type="checkbox"/>	Details	
SU11: DMS Maintenance	02	Certification Operators need to be able to quantify the performance of ITS Objects so that an object's	Medium	<input checked="" type="checkbox"/>	<input type="checkbox"/>		<input type="checkbox"/>	Details	
	01	Operating agencies need to be able to maintain ITS devices that are installed in the field so that the	Medium	<input checked="" type="checkbox"/>	<input type="checkbox"/>		<input type="checkbox"/>	Details	
SU11: DMS Maintenance	02	Operating agencies need to be able to perform the maintenance on ITS devices remotely or in the	Medium	<input checked="" type="checkbox"/>	<input type="checkbox"/>		<input type="checkbox"/>	Details	

The Needs grid has the following features:

- The first column is the Service Package or Area.
- The number column is to help you sort the needs. SET-IT doesn't enforce any rules on the numbering; it can take numbers or alpha characters. Model Document based needs will show a hierarchical listing of needs.

- The needs text comes next – either from ARC-IT or a user defined need. You can and should edit the needs to reflect your project's needs.
- The Priority column can be used to show the priority for that need – Low, Medium, High, or Not Applicable. The default is Medium.
- The Applicable column is a checkbox to show whether or not that particular need is assigned to your project. As you include new service packages the needs for that service package will be included and checked. Then you can uncheck the ones that don't apply to your situation.
- The Info Only column is used to tag rows that are Informational in nature. These usually are referring to header text from a source document like the FHWA Model SE Documents.
- The comment column is optional but may be used to describe some of the background behind what was driving a particular need or other considerations reviewers may need to be aware of.
- The User Defined checkbox is read-only and indicates whether the text or characteristics of the need have been modified from what ARC-IT defined or if it was created from scratch.

NOTE: if you have multiple instances of a service package with multiple copies of Needs for each instance make sure you customize the needs so they are unique in some way. You can do this by editing the text so the subject of the needs matches the enterprise or stakeholder organization responsible for the service. This will prevent having issues with duplicate needs when you export the project into RAD-IT to become part of a regional architecture.

As a user tailors an ARC-IT need the requirements traced to that original ARC-IT need will automatically be traced to the new user defined need. As an example, in TM01 Need #1:

"Traffic Operations need to be able to monitor the road network using infrastructure devices in order to detect and verify incidents and support implementation of traffic operational strategies."

That need is traced to 8 different functional requirements across 2 physical objects and 4 functional objects. As you tailor the need to, for instance, replace "Traffic Operations" with "xState DOT Regional Traffic Operations" then the original need is un-included from the architecture and replaced with the new need. The requirements associated with that need are now traced to the newly customized/tailored need.

If you have selected one of the service packages for which a Model Systems Engineering Document was written, then you will see a different looking set of Need numbers. These will look like a hierarchical set of numbers based on the source Model Document from FHWA.

Need Area	Include	✓	Need #	Need	Priority	Info Only	Comment	User Defined	More...
TM06.1: Dynamic Message Signs (Traffic Information Dissemination) (Copy 1)	<input checked="" type="checkbox"/>		0	Note: There is a wide variety of DMS	Medium	<input checked="" type="checkbox"/>		<input checked="" type="checkbox"/>	Details
	<input checked="" type="checkbox"/>		1	Control Access to DMS Management	Medium	<input checked="" type="checkbox"/>		<input checked="" type="checkbox"/>	Details
	<input checked="" type="checkbox"/>		1.1	The DMS System Manager needs access	Medium	<input type="checkbox"/>		<input checked="" type="checkbox"/>	Details
	<input checked="" type="checkbox"/>		1.1.1	The DMS System Manager needs access	Medium	<input type="checkbox"/>		<input checked="" type="checkbox"/>	Details
	<input checked="" type="checkbox"/>		1.1.1.1	The DMS System Manager needs to	Medium	<input type="checkbox"/>		<input checked="" type="checkbox"/>	Details
	<input checked="" type="checkbox"/>		1.1.1.2	The DMS System Manager needs to	Medium	<input type="checkbox"/>		<input checked="" type="checkbox"/>	Details
	<input checked="" type="checkbox"/>		1.1.2	The DMS System Manager needs access	Medium	<input type="checkbox"/>		<input checked="" type="checkbox"/>	Details
	<input checked="" type="checkbox"/>		1.1.3	The DMS System Manager needs access	Medium	<input type="checkbox"/>		<input checked="" type="checkbox"/>	Details
	<input checked="" type="checkbox"/>		1.1.4	The DMS System Manager needs access	Medium	<input type="checkbox"/>		<input checked="" type="checkbox"/>	Details
	<input checked="" type="checkbox"/>		1.1.5	The DMS System Manager needs access	Medium	<input type="checkbox"/>		<input checked="" type="checkbox"/>	Details
	<input checked="" type="checkbox"/>		1.2	The DMS System User needs access to	Medium	<input type="checkbox"/>		<input checked="" type="checkbox"/>	Details
	<input checked="" type="checkbox"/>		1.2.1	The DMS System User needs access to	Medium	<input type="checkbox"/>		<input checked="" type="checkbox"/>	Details
	<input checked="" type="checkbox"/>		1.2.2	The DMS System User needs access to	Medium	<input type="checkbox"/>		<input checked="" type="checkbox"/>	Details
	<input checked="" type="checkbox"/>		1.2.3	The DMS System User needs access to	Medium	<input type="checkbox"/>		<input checked="" type="checkbox"/>	Details
	<input checked="" type="checkbox"/>		1.3	The DMS System Maintainer needs access	Medium	<input type="checkbox"/>		<input checked="" type="checkbox"/>	Details

See "[Creating a New Need](#)" from the ribbon for more information about how to create a new need.

Requirements

Once Needs are understood and documented the next step in the Systems Engineering process is to identify and document the Requirements for a project. This is a critical step as requirements form the basis for scoping the work of designers and developers as well as frame the scope of what is to be tested at the end of the development process in order to 'sell-off' and accept the system.

ARC-IT decomposed the service package level Needs and developed a set of functional requirements for each of the functional objects in the physical view. You can use those requirements as starting points for the development of your own project's system requirements.

You may also import Requirements from one of the FHWA Model Systems Engineering Documents. Use Requirements Options to change the source of your project to use one of the Model Systems Engineering (SE) documents published by FHWA then select one of the services for which the model documents were based. SET-IT will import the needs and requirements associated with the model document in place of the ARC-IT needs and requirements written for that service package.

The table below shows which services are connected to the model documents.

SP Identifier	Service Package (SP) Name	SP Implementation	Model SE Document
TM01.1	Infrastructure Based Traffic Surveillance	Detector Based Surveillance	Traffic Sensing and Detection Systems (TSDS)
TM01.2	Infrastructure Based Traffic Surveillance	Video Monitoring	Closed Circuit Television (CCTV) Systems
TM03	Traffic Signal Control		Central Traffic Signal Systems
TM06.1	Traffic Information Dissemination	Dynamic Message Signs	Dynamic Message Sign (DMS) Systems

NOTE: More than one copy of a model document cannot be added to the same project. You will get a warning message to that effect if you try to include a 2nd copy of one of the service packages listed above.

SET-IT supports 2 options – Functional Object level requirements or System level requirements. Functional Object level requirements were the original requirements written in ARC-IT. The system level requirements are meant to be higher level collections of requirements that pertain to the entire system of interest. They typically begin with the phrase, "The system shall." See the "Requirements Options" settings for more information how to switch between System level and Functional Object or Element level.

Requirements Grid

Depending on the Requirements Options the Requirements grid will display either the system level requirements for the project or the requirements for each functional object included in the service packages of the project. There will be an indicator at the top of the grid or table showing which mode you are in.

Shown below is the Requirements grid in "system" mode:

System Requirements											
Service Package	Number	Requirement	Source	Verification	Type	Info Only	Comment	User Defined	In My Project	✓	More...
TM06	1.1	Access Control	Model Systems Engineering		Functional/Performance	<input checked="" type="checkbox"/>		<input type="checkbox"/>	<input checked="" type="checkbox"/>		Details
TM06	1.1.1	The DMS Management System shall enforce access control of all users.	Model Systems Engineering	Demonstration	Functional/Performance	<input type="checkbox"/>		<input type="checkbox"/>	<input checked="" type="checkbox"/>		Details
TM06	1.1.2	The DMS Management System shall allow the DMS System Manager to assign access control credentials to DMS System	Model Systems Engineering	Demonstration	Functional/Performance	<input type="checkbox"/>		<input type="checkbox"/>	<input checked="" type="checkbox"/>		Details
TM06	1.1.3	The DMS Management System shall allow the DMS System Manager to assign access control credentials to DMS System	Model Systems Engineering	Demonstration	Functional/Performance	<input type="checkbox"/>		<input type="checkbox"/>	<input checked="" type="checkbox"/>		Details
TM06	1.1.4	The DMS Management System shall allow the DMS System Manager to select the DMS Field Equipment.	Model Systems Engineering	Demonstration	Functional/Performance	<input type="checkbox"/>		<input type="checkbox"/>	<input checked="" type="checkbox"/>		Details
TM06	1.1.5	The DMS Management System shall allow the DMS System Manager to control the DMS Field Equipment.	Model Systems Engineering	Demonstration	Functional/Performance	<input type="checkbox"/>		<input type="checkbox"/>	<input checked="" type="checkbox"/>		Details
TM06	1.1.6	The DMS Management System shall allow the DMS System Manager to control external devices attached to the DMS	Model Systems Engineering	Demonstration	Functional/Performance	<input type="checkbox"/>		<input type="checkbox"/>	<input checked="" type="checkbox"/>		Details
TM06	1.1.7	The DMS Management System shall allow the DMS System Manager to access its logged data.	Model Systems Engineering	Demonstration	Functional/Performance	<input type="checkbox"/>		<input type="checkbox"/>	<input checked="" type="checkbox"/>		Details
TM06	1.1.8	The DMS Management System shall allow the DMS System Manager to grant access to the DMS Management System by the	Model Systems Engineering	Demonstration	Functional/Performance	<input type="checkbox"/>		<input type="checkbox"/>	<input checked="" type="checkbox"/>		Details
TM06	1.1.9	The DMS Management System shall allow the DMS System User to select DMS Field Equipment.	Model Systems Engineering	Demonstration	Functional/Performance	<input type="checkbox"/>		<input type="checkbox"/>	<input checked="" type="checkbox"/>		Details

Shown next is the Requirements grid in "element" mode:

Element Requirements											
Functional Object	✓	Number	Requirement	Source	Verification	Type	Info Only	Comment	User Defined	In My Project	More...
MCM Vehicle Tracking	<input checked="" type="checkbox"/>	01	The center shall monitor the locations of all maintenance and construction vehicles and other equipment under its	ARC-IT		Functional/Performance	<input type="checkbox"/>		<input type="checkbox"/>	<input type="checkbox"/>	Details
MCM Vehicle Tracking	<input checked="" type="checkbox"/>	02	The center shall present location data to center personnel for the fleet of maintenance and construction vehicles and other	ARC-IT		Functional/Performance	<input type="checkbox"/>		<input type="checkbox"/>	<input type="checkbox"/>	Details
MCV Vehicle Location Tracking	<input checked="" type="checkbox"/>	01	The maintenance and construction vehicle shall track its current location.	ARC-IT		Functional/Performance	<input type="checkbox"/>		<input type="checkbox"/>	<input type="checkbox"/>	Details
MCV Vehicle Location Tracking	<input checked="" type="checkbox"/>	02	The maintenance and construction vehicle shall send the time stamped vehicle location to the controlling center.	ARC-IT		Functional/Performance	<input type="checkbox"/>		<input type="checkbox"/>	<input type="checkbox"/>	Details

Use the Definitions menu (on the bottom left side of the window) with the Physical view selected at the top to add and edit your Requirements.

The *Requirements* button opens a table or grid to show the requirements that have been imported for the service package (in System mode) or for each of the functional objects from the service packages you included as well as new or user defined requirements you created.

- The number column is to help you sort the needs. SET-IT doesn't enforce any rules on the numbering except they have to be numbers (no alphas). You can also use a hierarchical or outline number scheme to make an outline list, e.g., "1.2.1.7".
- The requirement text comes next – either from ARC-IT or a user defined requirement. You can and should edit the requirements to reflect your project's scope. Click the Details button to edit a requirement from ARC-IT.
- The source column shows where the requirement came from, e.g., ARC-IT or another source. Use the Details form to edit and add to the list of sources. An example of a source for requirements might be one of the FHWA Model SE Documents, your project's ConOps or the project's Statement of Work (SOW).
- The verification method column provides a pull-down to identify the manner in which a requirement can be verified. The choices are Inspection, Analysis, Demonstration, and Test.

- Inspection refers to the ability to see or inspect an article and tell that a requirement is met – usually for things like safety codes, or software standards.
- Analysis is meant for situations like inspection that may require further work to determine that a requirement is satisfied – taking samples of the output and running them through a spreadsheet to calculate whether the requirement is satisfied.
- Demonstration, usually the most used, is for requirements that can be verified through use of the system, such as a user interface or use of a device in the field.
- Test, the most stringent method, refers to the type of verification that requires additional test equipment and very tight procedures and precise conditions in order to verify the requirement, such as installing network analyzers on an interface to determine the performance of a video switching device.
- The Type column is next and indicates the type of requirement. Most requirements will be Functional/Performance that is they deal with the functionality of the system or the performance of it. The following table lists the types of requirements you can select for a user defined requirement or that you might see used for an imported set:

Requirement Type	Description
Functional/Performance	Performance requirements associated with a particular function.
Interface	Requirements directly related to interfaces that are not captured elsewhere (e.g., as functional requirements). Likely to include specific protocol and physical connectivity requirements.
Usability/Quality-in-Use	Requirements associated with measurable effectiveness, efficiency, satisfaction criteria.
Functional	Requirements describing functions performed by the system.
Performance	Requirements on overall system performance, including those associated with a particular system mode or state.
System Operations	Requirements related to human systems operation, reliability, portability, compatibility, maintenance, and maintainability (e.g., mean and max downtime, maintenance intervals, component accessibility)
Modes and States	Requirements related to modes of operation and transitions between modes/states.
Physical Characteristics	Requirements related to growth, expansion/contraction. Constraints on weight, volume, and dimension. Construction characteristics relevant to installation, and requirements associated with materials, nameplates, marking and workmanship.
Environmental Conditions	Requirements associated with the environment, such as temperature, humidity, wind, rain, fungus, salt spray, radiation, immersion, or any other environmental condition relevant to the installation environment. Requirements related to the electromagnetic signal environment, threats (e.g., wild animals) and laws/regulations.
Security	Requirements related to physical security, cybersecurity and privacy that are not categorized elsewhere.

Requirement Type	Description
Policy and Regulation	Requirements that exist only because of a particular policy, regulation or business practice that are not categorized elsewhere.
Packaging, Handling, Shipping and Transportation	Requirements related to packaging and shipping the system prior to its installation.

- The comment column is optional but may be used to describe some of the background behind what was driving a particular requirement or other considerations reviewers may need to be aware of.

Clicking the Details button on the far-right column opens the Requirements Details form:

Requirement Details

Number: User Defined

Requirement:

Information Only Hyperlink

Supports Need(s):

SU01: Connected Vehicle System Monitor: 02 VS08: Queue Warning: 02
 VS08: Queue Warning: 01 VS08: Queue Warning: 03

Source: Type:

Verification: Creation Date:

Functional Object: Last Update Date:

Comment:

Element Requirement Allocation				
Include	Priority	Element	Functional Object	Comment
<input checked="" type="checkbox"/>	Medium	MCDOT CV Roadside Equipmer	RSE Device Management	
<input checked="" type="checkbox"/>				

Form Source: Grid - Requirements

This Details form contains the same data as the data shown in the columns in the Requirements Definitions grid. In addition to what was on the grid the Details form lets you see the mapping to the Needs that this requirement supports and the Element allocation (if in Elements mode). You can use this form to make changes or add text. When you change the text of an ARC-IT requirement SET-IT will create a new requirement with the next number in the series. You will notice that the grid is updated with the User Defined checkbox checked.

If you edit the text of an ARC-IT sourced requirement it will include or assign that new requirement to your project but you will then need to use the Requirement Allocation grid to Un-include the original requirement.

You can also use the Details form to assign a requirement to a particular element and to a particular functional object. This will be useful later in the project to generate test verification procedures.

To *delete* a requirement simply highlight the row from the main Requirements grid and click the Delete key.

Requirement Allocation Grid

The two requirements modes apply here as well. In Element mapping mode, the Requirement Allocation grid is used to show how the Elements and their Functional Objects are assigned to requirements.

Element Requirements							
Requirement Allocation							
Include	Priority	Element	Functional Object	Number	Requirement	User Defined	More...
<input checked="" type="checkbox"/>	Not Applicable	MCDDOT CV Roadside	RSE security support	10	The RSE Object shall request permissions from the Center. User manages permissions requests.	<input type="checkbox"/>	Details
<input checked="" type="checkbox"/>	Not Applicable	MCDDOT CV Roadside	RSE Device Management	01	The field element shall monitor the operational status (state of the device, configuration, and fault data) of	<input type="checkbox"/>	Details
<input checked="" type="checkbox"/>	Not Applicable	MCDDOT CV Roadside	RSE Device Management	02	The field element shall send operational status of connected field equipment to the maintenance center.	<input type="checkbox"/>	Details
<input checked="" type="checkbox"/>	Not Applicable	MCDDOT CV Roadside	RSE Device Management	03	The field element shall send collected fault data to the maintenance center for repair.	<input type="checkbox"/>	Details
<input checked="" type="checkbox"/>	Not Applicable	MCDDOT CV Roadside	RSE Device Management	04	The field element shall include a local interface that provides operational status and fault data for connected field	<input type="checkbox"/>	Details
<input checked="" type="checkbox"/>	Medium	MCDDOT CV Roadside	RSE Device Management	05	The field element shall include a local interface that allows field personnel to command diagnostic tests on	<input type="checkbox"/>	Details
<input checked="" type="checkbox"/>	Not Applicable	MCDDOT CV Roadside	RSE Device Management	06	The field element shall provide operational status information to the Service Monitor.	<input type="checkbox"/>	Details
<input checked="" type="checkbox"/>	Not Applicable	MCDDOT CV Roadside	RSE Device Management	07	The field element shall implement configuration commands received from an authorized Center.	<input type="checkbox"/>	Details
<input checked="" type="checkbox"/>	Not Applicable	MCDDOT CV Roadside	RSE Device Management	08	The field element shall implement operational status commands received from an authorized Center.	<input type="checkbox"/>	Details
<input checked="" type="checkbox"/>	Not Applicable	MCDDOT CV Roadside	RSE Device Management	09	The field element shall implement operational status commands received from authorized Field Support Equipment.	<input type="checkbox"/>	Details
<input checked="" type="checkbox"/>	Not Applicable	MCDDOT CV Roadside	RSE Device Management	10	The field element shall implement configuration commands received from authorized Field Support Equipment.	<input type="checkbox"/>	Details
<input checked="" type="checkbox"/>	Not Applicable	MCDDOT CV Roadside	RSE Environmental Monitoring	01	The field element shall communicate with passing vehicles to collect environmental monitoring data, including	<input type="checkbox"/>	Details
<input checked="" type="checkbox"/>	Not Applicable	MCDDOT CV Roadside	RSE Environmental Monitoring	02	The field element shall aggregate and forward collected environmental probe information to the center.	<input type="checkbox"/>	Details
<input checked="" type="checkbox"/>	Not Applicable	MCDDOT CV Roadside	RSE Environmental Monitoring	03	The field element shall collect environmental monitoring data from sensors, including ambient air quality, emissions,	<input type="checkbox"/>	Details
<input checked="" type="checkbox"/>	Not Applicable	MCDDOT CV Roadside	RSE Environmental Monitoring	04	The field element shall provide application status to the center for monitoring.	<input type="checkbox"/>	Details
<input checked="" type="checkbox"/>	Not Applicable	MCDDOT CV Roadside	RSE Environmental Monitoring	05	The field element shall aggregate and filter the collected environmental data based on configuration parameters	<input type="checkbox"/>	Details

This provides a way to see what all is assigned to an element. Until the requirement text is tailored this will be mostly Read Only. The columns show the Priority, the Element name, the functional object, the requirement number, and the requirement text. The details button will bring up details as was seen in the previous section where you can edit the text and the other details like the mapping to needs.

In System Requirements mode the Requirement Allocation grid provides a place to see the list of requirements for the system, as defined by the selected service package instance.

System Requirements							
Requirement Allocation							
Include	Priority	SP Instance	Number	Requirement	User Defined	More...	
<input checked="" type="checkbox"/>	Medium	TM06.1: Dynamic	1.1	Access Control	<input checked="" type="checkbox"/>	Details	
<input checked="" type="checkbox"/>	Medium	TM06.1: Dynamic	1.1.1	The DMS Management System shall enforce access control of all users.	<input checked="" type="checkbox"/>	Details	
<input checked="" type="checkbox"/>	Medium	TM06.1: Dynamic	1.1.2	The DMS Management System shall allow the DMS System Manager to assign access control	<input checked="" type="checkbox"/>	Details	
<input checked="" type="checkbox"/>	Medium	TM06.1: Dynamic	1.1.3	The DMS Management System shall allow the DMS System Manager to assign access control	<input checked="" type="checkbox"/>	Details	
<input checked="" type="checkbox"/>	Medium	TM06.1: Dynamic	1.1.4	The DMS Management System shall allow the DMS System Manager to select the DMS Field	<input checked="" type="checkbox"/>	Details	
<input checked="" type="checkbox"/>	Medium	TM06.1: Dynamic	1.1.5	The DMS Management System shall allow the DMS System Manager to control the DMS Field	<input checked="" type="checkbox"/>	Details	
<input checked="" type="checkbox"/>	Medium	TM06.1: Dynamic	1.1.6	The DMS Management System shall allow the DMS System Manager to control external devices	<input checked="" type="checkbox"/>	Details	
<input checked="" type="checkbox"/>	Medium	TM06.1: Dynamic	1.1.7	The DMS Management System shall allow the DMS System Manager to access its logged data.	<input checked="" type="checkbox"/>	Details	
<input checked="" type="checkbox"/>	Medium	TM06.1: Dynamic	1.1.8	The DMS Management System shall allow the DMS System Manager to grant access to the DMS	<input checked="" type="checkbox"/>	Details	
<input checked="" type="checkbox"/>	Medium	TM06.1: Dynamic	1.1.9	The DMS Management System shall allow the DMS System User to select DMS Field Equipment.	<input checked="" type="checkbox"/>	Details	
<input checked="" type="checkbox"/>	Medium	TM06.1: Dynamic	1.1.10	The DMS Management System shall allow the DMS System User to control DMS Field Equipment.	<input checked="" type="checkbox"/>	Details	
<input checked="" type="checkbox"/>	Medium	TM06.1: Dynamic	1.1.11	The DMS Management System shall allow the DMS System User to control external devices.	<input checked="" type="checkbox"/>	Details	
<input checked="" type="checkbox"/>	Medium	TM06.1: Dynamic	1.1.11.1	The DMS Management System shall control external devices such as flashers or beacons when	<input checked="" type="checkbox"/>	Details	
<input checked="" type="checkbox"/>	Medium	TM06.1: Dynamic	1.1.11.2	The DMS Management System shall allow the DMS System User to specify automatically	<input checked="" type="checkbox"/>	Details	

The grid will show the requirement Priority, what Service Package Instance it aligns with, the requirement number, the text, and a flag indicating User Defined. Use the Details grid as shown previously to change the text and characteristics for this requirement.

Needs to Requirements Grid

The Needs to Requirements Grid may at first seem repetitive but it is cleaner to have separate grids for editing the mapping between requirements needs. This Needs to Requirements grid allows the user to focus on need numbers, need text, and corresponding requirement numbers and requirement text. The relevant text can be edited in either the Needs or Requirement grid.

System Requirements							
In My Project		Needs to Requirements					
✓	Need Area	Need #	Need	Req #	Requirement	SP	
✓	TM06.1: Dynamic Message	1	Control Access to DMS Management System (Choose the user	1.1	Access Control	TM06	
✓	TM06.1: Dynamic Message	1.1	The DMS System Manager needs access to the DMS Management	1.1.1	The DMS Management System shall enforce access control	TM06	
✓	TM06.1: Dynamic Message	1.1.1	The DMS System Manager needs access for DMS Management	1.1.1	The DMS Management System shall enforce access control	TM06	
✓	TM06.1: Dynamic Message	1.1.1.1	The DMS System Manager needs to configure DMS System User	1.1.2	The DMS Management System shall allow the DMS System	TM06	
✓	TM06.1: Dynamic Message	1.1.1.2	The DMS System Manager needs to configure DMS System	1.1.3	The DMS Management System shall allow the DMS System	TM06	
✓	TM06.1: Dynamic Message	1.1.2	The DMS System Manager needs access to the DMS Management	1.1.4	The DMS Management System shall allow the DMS System	TM06	
✓	TM06.1: Dynamic Message	1.1.3	The DMS System Manager needs access to the DMS Management	1.1.5	The DMS Management System shall allow the DMS System	TM06	
✓	TM06.1: Dynamic Message	1.1.4	The DMS System Manager needs access to the DMS Management	1.1.6	The DMS Management System shall allow the DMS System	TM06	
✓	TM06.1: Dynamic Message	1.1.5	The DMS System Manager needs access to the DMS Management	1.1.7	The DMS Management System shall allow the DMS System	TM06	
✓	TM06.1: Dynamic Message	1.2	The DMS System User needs access to the DMS Management	1.1.8	The DMS Management System shall allow the DMS System	TM06	
✓	TM06.1: Dynamic Message	1.2.1	The DMS System User needs access to the DMS Management	1.1.9	The DMS Management System shall allow the DMS System	TM06	
✓	TM06.1: Dynamic Message	1.2.2	The DMS System User needs access to the DMS Management	1.1.10	The DMS Management System shall allow the DMS System	TM06	
✓	TM06.1: Dynamic Message	1.2.3	The DMS System User needs access to the DMS Management	1.1.11	The DMS Management System shall allow the DMS System	TM06	
✓	TM06.1: Dynamic Message	1.2.3	The DMS System User needs access to the DMS Management	1.1.11.1	The DMS Management System shall control external devices	TM06	
✓	TM06.1: Dynamic Message	1.2.3	The DMS System User needs access to the DMS Management	1.1.11.2	The DMS Management System shall allow the DMS System	TM06	
✓	TM06.1: Dynamic Message	1.3	The DMS System Maintainer needs access to the DMS	1.1.12	The DMS Management System shall allow the DMS System	TM06	
✓	TM06.1: Dynamic Message	1.3.1	The DMS System Maintainer needs access to the DMS	1.1.13	The DMS Management System shall allow the DMS System	TM06	
✓	TM06.1: Dynamic Message	1.3.2	The DMS System Maintainer needs access to the DMS	1.1.14	The DMS Management System shall allow the DMS System	TM06	
✓	TM06.1: Dynamic Message	1.3.3	The DMS System Maintainer needs access to the DMS	1.1.15	The DMS Management System shall allow the DMS System	TM06	
✓	TM06.1: Dynamic Message	1.3.4	The DMS System Maintainer needs access to the DMS	1.1.16	The DMS Management System shall allow the DMS System	TM06	

Using the Left Menu

The left menu is a unique way that SET-IT uses to organize the work for developing a project architecture. Depending on the View it will let you see your architecture from different perspectives. In the physical view it is divided into 3 sections: Overview, Diagrams, and Definitions. Clicking on each one brings up a set of button's pertaining to that part of the architecture.

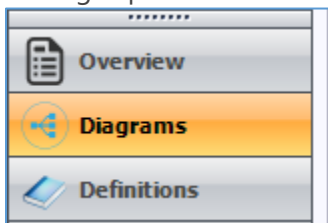

In the Enterprise View there are 2 buttons: Diagrams and Definitions.

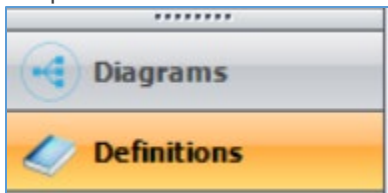

In the Communications View there is currently just 1 button: Definitions.

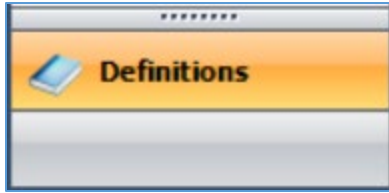

Overview Menu

The Overview menu, available from the Physical View, provides the following buttons to organize high-level information about the project, including:

- Project (basic project scoping information)
- Service Packages (a list of service packages that can or have been included in your project)
- Change Log (a way to list when changes were made and who made them)
- Notes (an area to type notes about the overall project) There are Notes boxes in each View – physical, enterprise, and communications.

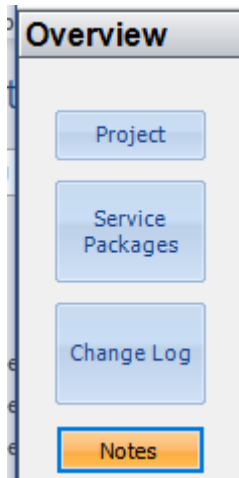

Diagrams Menu

Diagrams provides a list of the diagrams that have been copied/included from ARC-IT or created from scratch. Once you have selected Diagrams from the left menu and you have a list of diagrams on the left side of the screen there are several options you can do:

- **Sort** – Right-click on the area above the first diagram or in any empty areas around the diagram names. A context menu will appear giving you the choice of sorting by the Name of the service package, either ascending or descending, or by the Layer and then the Name, also either ascending or descending. This can be useful once you have a large architecture project with lots of diagrams.
- **Rename** – Right-click above one of the diagram names and another context menu appears with more choices, including Rename. Click Rename and a dialog box will open

to let you type the new name and say OK or Cancel. SET-IT will automatically change the name of the service package instance in the Definitions grid.

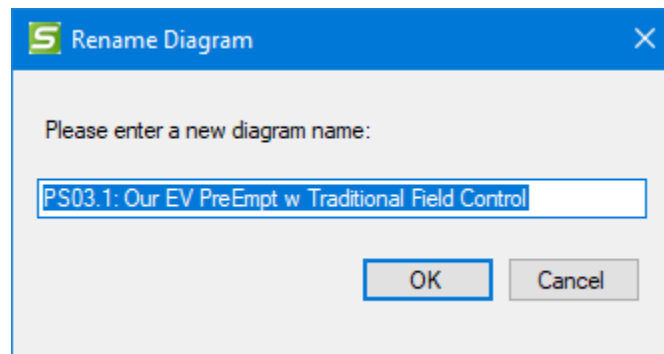
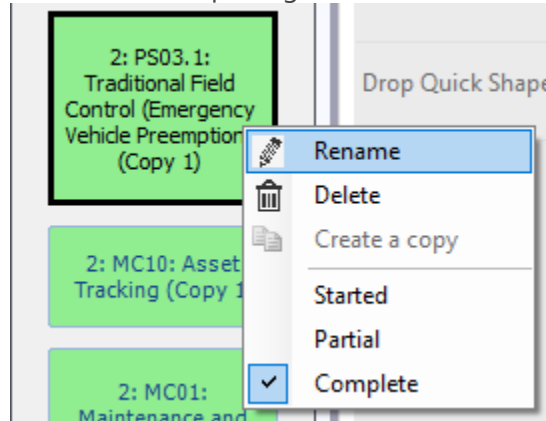

- **Copy** – (no longer an option.) Go to Overview and include another instance of the same service package
- **Delete** – Right-click above one of the diagram names and select Delete to simply delete an entire diagram. The definitions of the objects, elements and flows will still be in the database since they may be used on other diagrams. A series of dialog boxes will open to ask if you wish to delete the diagrams from the other views associated with this service package, if you want to remove the entire instance of the service package from the database, and finally to warn you that removing an entire instance of the Service Package cannot be Undone and you can say Yes or No.
- **Completion Status** - Right-click over the name button and assign a Completion Status of Started (default), Partial, or Complete. The color of the button will change accordingly so you can see at a glance how far along you are.
 - Pink/Red = Started
 - Yellow = Partial
 - Green = Complete

When you select Complete a set of queries will run to determine if you have completed the basic steps to edit your diagram. You may be told to open the Diagram Verification tool to see what steps you need to complete the diagram.

NOTE: changing the Diagram Name either on the Left Menu or on the Definitions grid does not change the name of the Service Package Instance. There is a separate grid where you can change that.

Definitions Menu

Definitions: provides a set of buttons that each will show a different component of the architecture and allow you to view and edit the information in a table or *grid* format.

Most grids allow you to view and edit information about components of your architecture. They may also have a Details button that opens a separate form where you can more easily view and edit information about a component.

You can sort the rows in the Definitions grids by simply clicking the header at the top of the column. Click it once to sort in ascending order and click it again to sort in descending order. The sorting function will sort first the column you selected and then sort the columns to the right. You can change how things are sorted by reordering the columns.

To reorder the columns click and hold the header at to top of the column and drag it where you want it to be.

Depending on the grid you can perform other functions to add to and edit your architecture. Some grids like the Service Packages grid are completely read-only. Other grids allow you to edit the information directly on the grid as you would expect to edit a table in a database. Most grids are a hybrid of the two with some columns as read-only and others as editable, like a Comment field. In many cases a Details button will let you see and edit the text and other details about the object.

On those editable grids you can delete a row by selecting the row and clicking the Delete key on the keyboard. You could also delete multiple records or rows by highlighting multiple rows and clicking Delete. Deletions will prompt SET-IT to display a warning message.

You can also add records to some grids directly if they have a row at the bottom with an asterisk on the left.

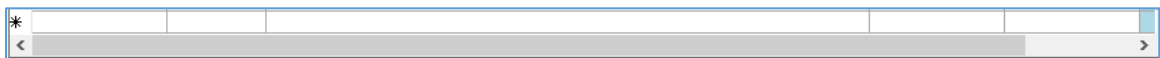

Start filling in the cells and it will start adding records to the database.

On the grids, the width of the columns can be adjusted.

Color coding or shading is used to indicate which cells are read-only (Blue) and which cells have been customized/edited (Beige or Tan) and which are editable (White) as shown below.

		Service Package Instances					
SP /	Name	Description	Parent Service Package	Parent Implementation	Service Area	Type(s)	Group(s)
SU01	MC Connected Vehicle System Monitor	This service package provides	Connected Vehicle System Monitoring and Management		Support	Support	Core Services
SU03	MC Data Distribution	This service package manages the	Data Distribution		Support	Informational, Support	Core Services
SU04	MC Map Management for V2I Safety	--Instance of SU04-- This service	Map Management		Support	Support	Core Services
SU05	MC Location and Time Services for V2I	--Instance of SU05-- This service	Location and Time		Support	Support	Core Services, Security
SU08	MC Security and Credentials	This service package is used to ensure	Security and Credentials Management		Support	Support	Core Services, Security
SU09	MC Device Certification and Enrollment	This service package is used to illustrate	Device Certification and Enrollment		Support	Support	Core Services, Security
SU11	MC DMS Maintenance	This service package supports	Field Equipment Maintenance		Support	Management	Maintenance and Construction
TI07	MC In-Vehicle Signage	This service package augments	In-Vehicle Signage		Traveler Information	Safety	V2I Safety
VS05	MC Curve Speed Warning	This service package allows connected	Curve Speed Warning		Vehicle Safety	Safety	V2I Safety
VS08.3	VS08.3: C-ITS Queue Warning (Queue	Short range communications supports	Queue Warning	C-ITS Queue Warning	Vehicle Safety	Mobility, Safety	Traffic Network, V2I Safety
VS09.3	VS09.3: C-ITS Reduced Speed Warning	Short range communications provides	Reduced Speed Zone Warning / Lane Closure	C-ITS Reduced Speed Warning	Vehicle Safety	Safety	Maintenance and Construction, Tra

Editing a cell directly in a grid is done by editing the white or beige cells. A change is committed to the database when you go to a different row or go to another grid. As you start typing you may notice the caret symbol changes to a pencil.



Once you commit that change by going to the next row you will see that the icon changes back to the caret.

On many grids you can use the Right-Click Menu to see options to sort the grid by the left column, either A-Z or Z-A.

You can also delete a row by highlighting a row using a Left-Click and then using Right-click and choosing Delete.

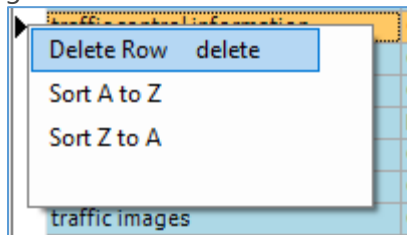

Some grids don't support Deleting this way – they require that they be unchecked in order to remove them from an architecture.

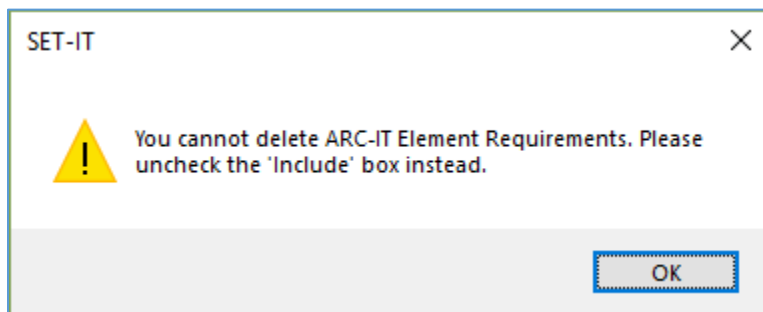

Some grids don't support editing on the grid directly or have a New row at the bottom. Elements, for instance, can be added by using the New Item menu at the top of the screen. That will add rows to the Elements definitions grid and then you can click the Details button on the Elements grid to edit its characteristics.

General Definitions Grid Features

On many of the Definitions windows you can also select **Details...** in order to edit any of the characteristics about the component using the dialog box format. If it is an ARC-IT defined component, then as you click OK you will be prompted as to whether you want to create a user defined copy of that component.

Undo and **Redo** are available on the Definitions grid as well.

Some grids like the Physical Information Flow Triples grid can be very wide so the first 3 columns will be frozen so you can keep track of which interface you are working with.

The Definitions grids use color coding to indicate whether or not a cell can be edited – **Blue** for not-editable and **White** for editable.

Another feature of the Definitions windows is the **In My Project** column. Press the check mark to the right of the column name and you can filter between All checked, all unchecked, or all rows allows you to see all of the rows that are actually *in your project*, or all of the rows that are currently *not in your project*, or just all of the rows combined. Sometimes you just want to see the things that pertain to your project vs having to scroll through all of the things from ARC-IT that may not be applicable to your situation. On the other hand, maybe you want to show what's not in your project yet but you may consider adding it.

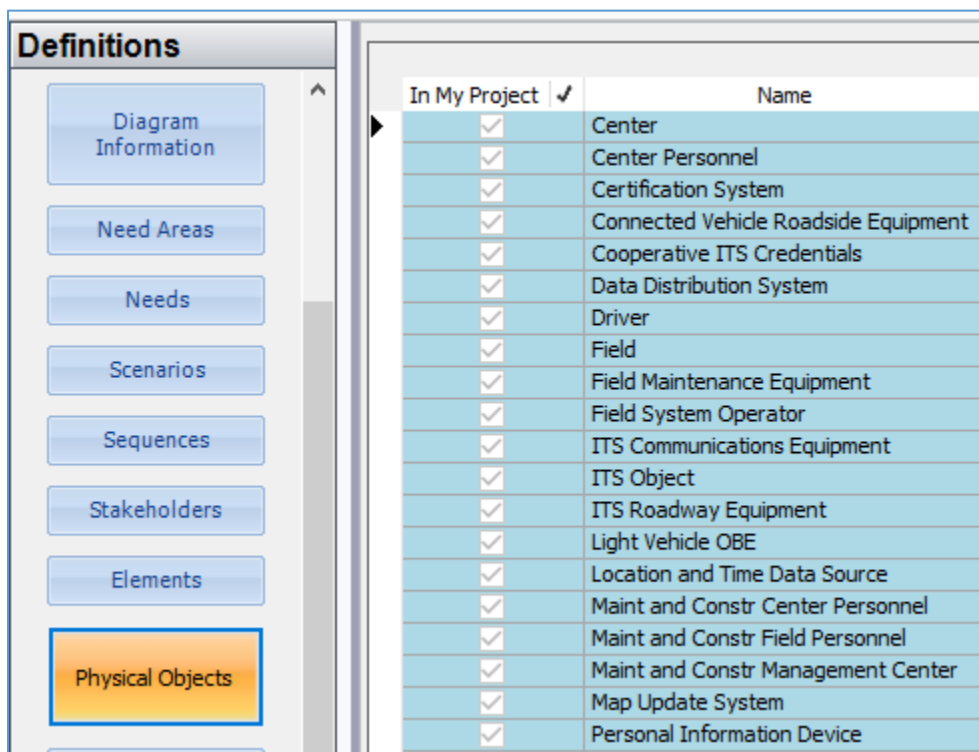

Other Columns can also be filtered in much the same way. Click on the top right of the column heading to bring up the filters menu. It will open to the Value Filter mode where each row is shown and you can decide which rows or all rows to show.

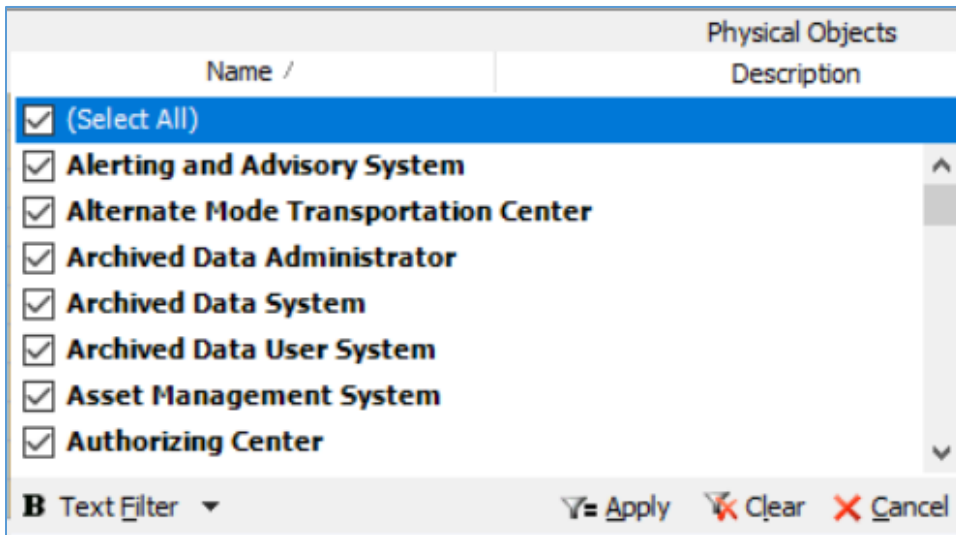

Or you can press the Text Filter button and you can provide parameters to show rows that contain certain words or phrases.

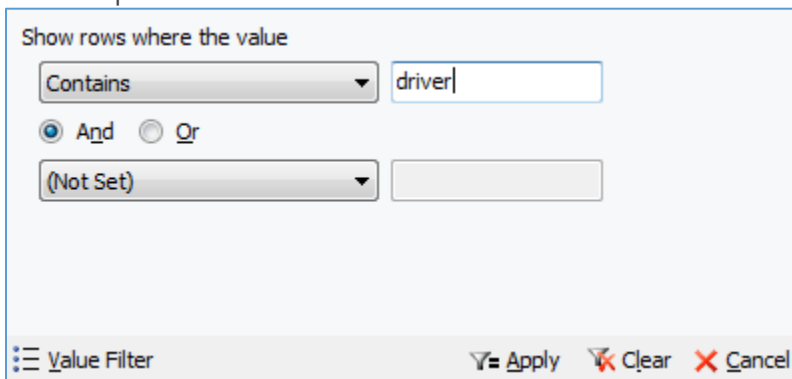

Then hit Apply to change the listing shown on the grid. Or use the Clear button to go back to the original view.

Filters can be a powerful way to select and review certain parts of your architecture. For example, you can filter the Relationships grid to only show your local/customized agreements by toggling the *User Defined* column.

To *delete* a row from the Definitions grid just highlight that row and click the <**Delete**> key. This will remove the item from the database.

If you delete something that is on the diagram then the Synchronization process will automatically remove it from the diagram.

Deleting a flow that appears on a diagram will remove the name of the flow but it may leave behind a line with nothing on it. That's OK. The line can be used to add another flow on that interface. Or if that interface is not needed at all then you can manually delete the line on the diagram.

Deleting more than one row in a grid is simple – just highlight the rows you want to delete and press the delete key.

TIP: Sometimes the menu items on the **Definitions** grid get sorted or resized and sometimes you could end up with extra space at the top of the left menu. If you notice this happening, simply resize the grid by clicking and dragging the right edge of the menu and moving it slightly to the right or left to force the menu to refresh itself.

Physical View Definitions

The following buttons are listed below for the *Physical View Definitions* menu, each of which corresponds to a table or grid of information:

Service Packages Grid

Service Packages allows you to view the description of the ARC-IT service packages or view/edit User Defined service packages. Use the New menu item to create your own service package from scratch. If a service package is one of the alternative implementations of a service package, e.g., VS09.3 Cooperative-ITS Reduced Speed Warning, then this grid also shows the name of the parent service package that it was derived from, in this case – Reduced Speed Zone Warning / Lane Closure.

Every column in the Service Packages grid is read-only. Use the Details button to edit the information. The following columns are viewable on the Service Packages grid:

- In My Project – a flag indicating whether or not a given row is part of your project
- SP – the short name for the service package, containing a 2 letter abbreviation for the service package area defined in ARC-IT and a number
- Name – the name of the service package
- Parent Service Package – the name of the higher-level or parent service package if the row is for a service package implementation
- Description – text description of the service package or service package implementation
- Service Area – from ARC-IT, a high-level area in which the service package is include, e.g., Vehicle Safety, Support, etc.
- Type(s) – also from ARC-IT, the type of services in which the service package is included, e.g., Safety, Management, etc.
- Group(s) – also from ARC-IT, the group of services in which the service package is included, e.g., Core Services, Security, etc.
- User Defined – a checkbox indicating that the service package has been developed by the user, i.e., not by ARC-IT
- More... – a Details button can be clicked to see more information about the service package

Service Package Instances Grid

Service Package Instances allows you to edit the description of the instances of the service packages that are included in your architecture. You can use this form to record the name and description of the service package and assign it to a Type (convenience, environmental, mobility, safety, support)

and Group. If a service package instance is one of the alternative implementations of a service package, e.g., "OurCounty Cooperative-ITS Reduced Speed Warning", then this grid also shows the name of the parent service package that it was derived from, in this case – Reduced Speed Zone Warning / Lane Closure, and the name of the implementation, C-ITS Reduced Speed Warning.

NOTE: Changing the name of a Service Package Instance will also automatically change the name of the Diagram which you can see when you go to the Diagram Information grid or go back to the Diagrams view.

The Name and Description columns are editable. Every other column in the Service Packages grid is read-only. Use the Details button to edit the information. The following columns are viewable on the Service Package Instances grid:

- SP – the short name for the service package, containing a 2 letter abbreviation for the service package area defined in ARC-IT and a number
- Name – the customized (and editable) name of the service package instance
- Description – an editable text description of the service package or service package implementation
- Parent Service Package – the service package name from ARC-IT (or from the Service Packages grid if it was user defined. if the row is for a service package implementation
- Parent Implementation – the service package implementation name from ARC-IT if the row is for a service package implementation
- Service Area – from ARC-IT, a high-level area in which the service package is include, e.g., Vehicle Safety, Support, etc.
- Type(s) – also from ARC-IT, the type of services in which the service package is included, e.g., Safety, Management, etc.
- Group(s) – also from ARC-IT, the group of services in which the service package is included, e.g., Core Services, Security, etc.
- Readiness – an indication of the overall 'Readiness' value for the service package. This value is calculated by summing up all of the issues related to communications solutions and their severities for each information flow triple in the customized service package instance. The value shown on the grid then is the worst of those values. So if one flow is not quite ready for deployment, as indicated by a number of issues and given a value of "Low" readiness then the entire service package will have that "Low" readiness. Possible values are: Impractical, Low, Moderate, High, and Highest
- More... – a Details button can be clicked to see more information about the service package instance. The details screen will also show the Worst Readiness Score and the information flows that are contributing or causing that score along with the issues driving that

Service Package Issues

Service Package Issues describes the issues associated with the information flows that make up a service package once it has been customized. As you customize the service packages in your architecture you are creating information flow triples that are mapped to Communications solutions. Each communications solution may have one or more issues associated with it, e.g., the Data Profile is not yet defined, there is an issue on data accuracy, or there are some overlaps that will need to be addressed when the project is deployed. These issues have varying levels of severity and can affect the overall readiness of that service package. This definitions grid provides a way to see the collective set of issues for all of the information flows in that service package instance – how many

there are and their overall severity as it pertains to their affect on the readiness to deploy a service. The columns show the worst readiness score for the collective set of issues associated with that service package. Likewise, for the individual flows it highlights the worst of the issues among those flows and shows what that is. Click Details to see the Service Package Details screen for more information.

Diagram Information

As you select and include service packages into your architecture an entry is added to Diagram Information which you can use to edit information about the diagram, including the Completion Status (started, partial, complete). If you change the status to Complete, then the queries to determine a diagram's completeness will be run. If any issues are found it will tell you to go to the diagram and use the Diagram Verification tool.

Stakeholders

The Stakeholders grid allows you to create a list of stakeholders (name and description) and associate them with different elements.

- Once created, use the details form to associate project stakeholders to the roles they play with respect to elements.
- SET-IT will verify that each role assignment is unique per element.
- You can also create a Stakeholder Group that consists of one or more stakeholders. This may be useful in situations where stakeholders have a joint role with a resource, e.g., the city traffic department and public safety agency have a joint operations center.
- To create a Stakeholder Group – start by creating the individual stakeholders and then create the group and select the members of the group from the list of stakeholders.

NOTE: You cannot have Groups of Groups.

Need Areas

The Need Areas grid shows the high level groups of needs such as Safety, Support services, or a user defined area. When a service package is included/imported this also imports a Need Area corresponding to that service package. You can also create your own Need Areas as groupings of needs for your project.

Needs

This grid shows the needs for the project. Needs are statements that describe functionality or capability that is necessary for a service to be provided. They can also be thought of as a problem or issue that is addressed by the functionality or capability provided by an enterprise or institution. SET-IT will warn you if it detects a duplicate need.

Scenarios

The Scenarios grid allows you to enter a name, a high-level description, and an order number of a scenario which describes how the system will be operated under various conditions. These text

descriptions will be used to introduce the scenarios sections in the ConOps document. They will be ordered in the document based on the order you provide.

Sequences

The Sequences grid allows you to define sequences of steps that make up a scenario; you can also assign one or more sequences to a physical diagram which connects the scenarios/sequences to a service package. The steps will be created on the diagram itself. Here on the sequence table, you can also assign a style for the background color used on the circles that will be used for the steps: White, Black, or Gray.

Elements

The Elements grid shows the localized or customized representations of physical objects in the architecture.

NOTE: Changing the class of an Element will invalidate the previous physical object mappings and so that element will be removed from any diagrams where it is already mapped.

NOTE: Unmapping some of the physical objects to an element may invalidate the shape properties on some diagrams. If you try to unmap an element to a physical object that is used on a diagram then SET-IT will warn you to first edit the diagram (remove that element from that physical object shape on those diagrams) then you can remove the mapping here.

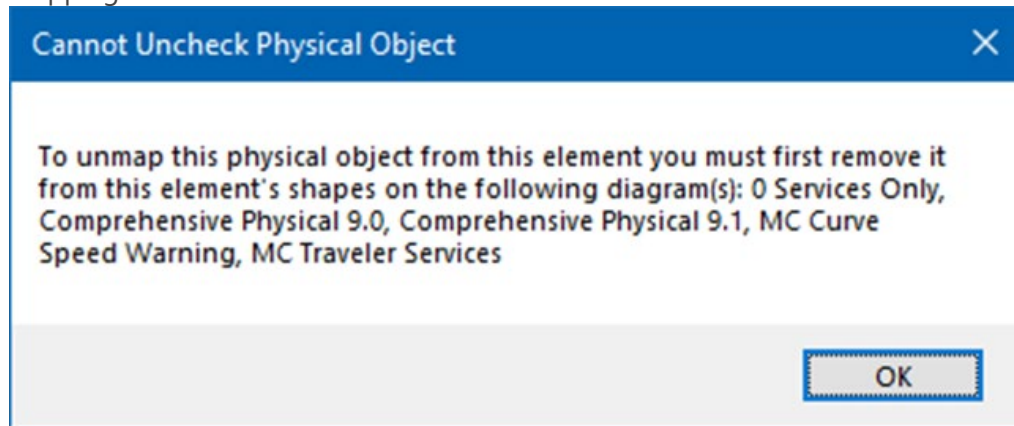

Physical Objects

The Physical Objects grid lists the system, human, and environmental objects that comprise the project. Physical Objects are represented as the larger colored boxes on the physical diagrams that include systems, devices, and users of the transportation systems, defined in ARC-IT. Your project may also contain user defined physical objects.

Functional Objects

Functional Objects represent the set of functions that are subsets of a physical object and support one or more service packages. The Functional Objects grid lets you view the name, description, and physical object assignment for the functional objects included in your project based on the service packages that have been included. Use the "In My Project" filter if you want to see all of the

functional objects in that database, including ones that are not yet defined in your project. Use the Details button if you want to read and customize the name or description of the functional object. As with other tables you can edit any user-defined objects freely. If you try to edit the name or description of a functional object from the ARC-IT reference architecture then it will prompt you to see if you want to create a user defined copy.

Information Flows

The Information Flows grid lists the flows of data between physical objects as defined in ARC-IT. May also contain user defined information flows that could be used and selected among service packages in the project. The Information Flow Details screen allows the user to enter a comment about the flow – for instance, why this flow is selected for this particular architecture.

- To delete a user defined flow from your architecture, highlight the row and click <Delete>. This will remove it from being selectable on any of your diagrams.
NOTE: if you have already used this on a diagram then you may notice a line with no flow name on it when you look at the diagram again. If you do not need that interface at all and you are not going to replace that with another flow, then just manually select the line on the diagram and delete it.
- You may see a flow called “(None)” if you add a line to a diagram and connect it to 2 physical objects but don’t create or assign a flow to that line. Go back to the diagram and delete the line or assign a flow.
- This grid also lets you see, edit, and apply an alias for an information flow. Aliases are ways to further customize your drawings without losing the connection to the ARC-IT reference.

Information Flow Triples

The Information Flow Triples grid lists the collections of locally selected information flows that connect source elements and destination elements along with characteristics for that 'triple'. The Information Flow Details screen allows the user to enter a comment about the flow – for instance, why this flow is selected for this particular architecture. If an alias was applied to a flow that alias will appear in this list with the original flow name in parentheses.

Status Values

Use the Status Values grid to see the list of status values and the order in which they are to be displayed. You can also use this to create your own status value and decide which is the default value. Use the Description field to explain to your audience what certain values mean.

P-Interconnects

The P-Interconnects, short for Physical Interconnects, grid lists the source and destination connections between Physical Objects that are connected together. Use the Details form to see what layer 2 information flows map to a layer 0 or layer 1 physical interconnect.

- **NOTE:** Not every flow maybe listed under the interconnect. Some flows like “data publication” are known as ‘superflows’ which are simply collections of information flows defined in ARC-IT that are being carried between elements over some communications path.

- **P-Interconnects** can also have an alias – used as a way to customize a Layer 0 or Layer 1 diagram for a project to be more meaningful than the default names used by ARC-IT.

P-Interconnect Triples

The P-Interconnect Triples grid lists the customized physical interconnects (P-Interconnects) which show the source and destination connections between Elements that are connected together in this project architecture. These are based on the flows that go between each element on the customized layer 2 diagrams.

If an alias was applied for a p-interconnect then it will appear in the list with the original P-Interconnect name in parentheses.

Requirements

The Requirements grid has 2 modes – system mode and elements mode depending on the Requirements Settings for the project on the Options menu. In Element mode it lists the Functional Object the requirement is from, the Need that the requirement supports, the unique number for this requirement within that need, the text of the requirement, the source (ARC-IT or other), the Verification method (Demo, Test, Analysis, or Inspection), Type, and a Comment. Use the Details button to edit the text in a separate window.

- ARC-IT's functional requirements have 2-way traceability. They are traced to the Needs that were written for each service package. They are also traced to the functional objects from each of the physical objects.

In System requirements mode it lists the service package (or SP implementation if applicable), requirement number, text, source, verification method, type (functional, performance, etc.), and a comment field.

Requirement Allocation

The Requirement Allocation grid lists the system or functional requirements by Element and Functional Object. In Element mode, this table shows the requirements that are assigned to an element. Entries are added to this grid once an element has been mapped to a physical object on a service package drawing then it inherits the functional requirements written for those functional objects that are in that physical object on the service package.

Here you can click to Include or Un-include a requirement for your project and tailor the requirement to match local concerns. Use the Priority column to assign a relative priority to a requirement. Click the Details... button to add comments or assign verification methods.

In System Requirements mode, this table simply shows the requirements from the previous grid and lets you assign a Priority to the requirements for your project. As with the Element Requirements mode you can also edit or tailor these requirements for your own project's situation.

Needs to Requirements

The Needs to Requirements grid lists the needs and the requirements that they are traced to. This type of Traceability table allows the user to see at a glance how requirements are mapped to needs and needs mapped to requirements. Changes to the text of needs or requirements or the mapping between them will need to be made back on their respective grids.

Standards

The Standards grid lists the standards that are potentially associated with physical or functional objects in this project. This grid is read only so changes to the ARC-IT imported definitions cannot be overridden. To add a standard to this grid, use the New Item from the menu and create a new standard.

Physical Objects Standards

The Physical Objects Standards grid lists the standards that are associated with physical or functional objects. This grid is read only so changes to the ARC-IT imported definitions cannot be overridden. To add a standard to this grid, use the New Item from the menu and create a new standard and add the physical objects and, optionally functional objects, this standard addresses. To map an existing standard to a new combination of physical/functional objects click the Details button and use the Physical/Functional Object mapping area of the Standards Details form.

- If you edit something on the Standards Details form, it will inform you that the standard is protected and that it will create a user defined version of that standard. It appends a number onto the end of the name and it is recommended that you make sure that is recognizable on your outputs for your project so readers know that it has been customized.

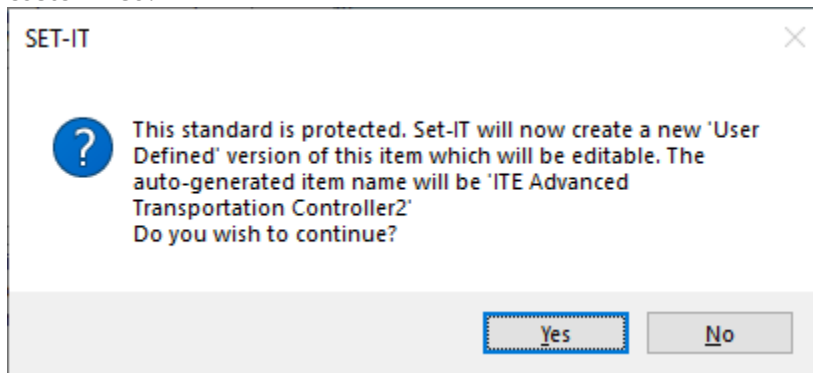

- You can add a physical object standard to this grid by clicking the "In My Project" check mark and change the filter to include all items – False and True. This will add a lot of rows to the table but it will also add a New row to the bottom of the table that will allow you to add a standard and map it directly to a physical and functional object.

Elements Standards

As you create elements and map them to physical objects and/or functional objects for which a physical standard has been defined then it will appear in this grid. Some physical standards are mapped to an entire physical object and as soon as you map an element to that physical object it will show up in the Elements Standards grid. Others are specific about which functional object they are mapped to so the element must be mapped to one of those functional objects. This happens as you assign elements to your service packages that show the physical and functional objects needed to implement a particular service. This grid has a Comment cell perhaps to indicate something specific about how an element is implementing a standard. This grid has a Details grid that shows the full list of standards associated with this Element and lets you Include or Un-Include a standard for that element.

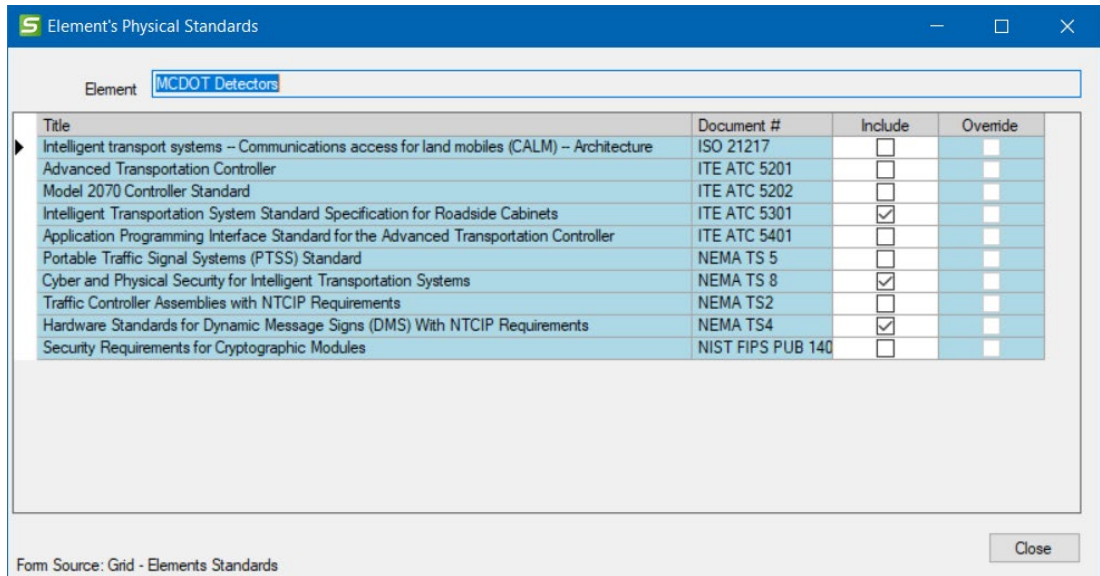

If you change a mapping that was provided by ARC-IT, then the Override box will be checked. You can click the Restore button and it will restore the standards that should be mapped to that element based on ARC-IT's mappings.

Assumptions and Constraints

This Assumptions and Constraints grid is used to capture any assumptions or constraints applicable to the changes and new features that will affect users during the life cycle of the new or modified system. An assumption is a condition that is taken to be true, e.g., the system workload will double over the next two years, thus a new system with higher performance is required. A constraint is an externally imposed limitation placed on the new or modified system or the processes used, e.g., external interface requirements and limits on schedule and budget. This table can be output from the Output / Tables menu or included as a section in your Concept of Operations (ConOps) document.

Enterprise View Definitions

The following buttons are shown on the *Enterprise View Definitions* menu:

- Service Package Instances – see above
- Service Packages – see above
- Diagram Information – see above
- Stakeholders – see above
- Elements – see above
- Status Values – see above
- Stakeholder Roles – a grid showing the relationships that stakeholders have with respect to the Elements. The columns include:
 - Stakeholder
 - Role: manages, owns, operates, uses, etc. (if this field is blank, it may mean that no role has been defined yet. Click Details to update the roles for this element)
 - Element

- Status (sometimes you may define the current operator but then identify another stakeholder that will operate the element after the system is deployed)
 - Details... - use this button to open the Elements Details form (yes, the Elements form) and you can go down to the stakeholder section and update the stakeholders and the roles they play with the element.
- Resources – the boxes on the enterprise diagrams that include systems, devices, and facilities of the connected vehicle environment, defined in ARC-IT.
- Roles – the relationships on the enterprise view diagrams that represent the way in which an enterprise object participates in a relationship from ARC-IT; an object's set of behaviors and actions associated with the relationship of that object with other objects.
 - The Required column lets you indicate which roles you want to see for each stakeholder and element.
- Agreements – the relationships on the enterprise view that represent the formal points of coordination between enterprise objects from ARC-IT; how they agree to interact with each other in order for a service to be provided.
- Agreement Types – a read-only grid showing the various types of agreements that are used in ARC-IT and can form the basis for the project-specific agreements you define on the Agreements and Relationships grid.
- Expectations – the relationships (lines) on the enterprise view that represent less formal points of coordination between enterprise objects from ARC-IT; how they expect one another to act and behave in the cooperative connected vehicle environment
- Relationships – the localized or customize set of relationships between stakeholders on the SET-IT project architecture enterprise view diagrams – may include agreements, expectations, or roles. Sorted by Service Package and life-cycle stage. These can be customized for your project by clicking Details and opening the same Agreements form available from the Agreements grid, described above.

Communications View Definitions

The graphic below depicts the buttons that make up the Definitions menu for the Communications View. Jump to the list [below](#) to see what information they include.

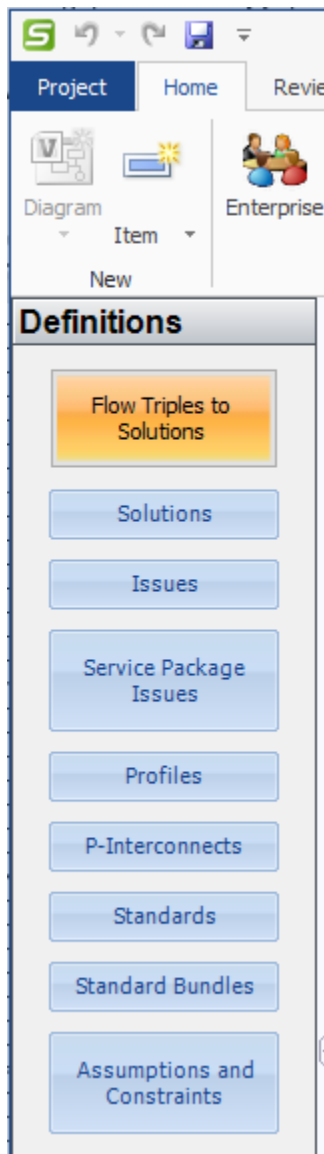

The following buttons are shown on the *Communications View Definitions* menu:

- Flow Triples to Solutions – This shows the mapping of information flows from the Physical View to the Communications Solutions. The information in this table is what drives the content for the creation of the Communications Diagrams. See "[Communications Diagrams](#)" in the Outputs section below. On the Details screen that accompanies this grid you can see which issues pertain to this Flow Triple Solution combination and can click the Ignore flag to cause the Readiness calculator to update the readiness of any service package that uses just this information flow triple and solution combination.

- Solutions – This lists the communications solutions used and available to the project. Each consists of a communications and a data profile. This grid also shows the Solutions Issue Score to indicate the relative readiness of a solution for deployment.
- Issues – This lists the severity, name, type, and description of the issues that have been attributed to standards and/or layers of the communications solutions in your project. It also includes an “Ignore” flag to indicate that this issue will not be used in the calculation of the ‘readiness’ or viability of a communication solution or used when those solution readiness values are rolled up to form the overall readiness for a service package. The solution score calculator considers any triple solution issue level ignore settings to determine solution scores for specific triples.
- Service Package Issues – This includes the overall readiness level and a list of issues for each service package instance. The Ignore flag indicates that an issue assigned to one of the communication solutions for the flows in that service package has been ignored. This can affect the Readiness level for the Service Package.

Readiness Levels have the following values:

Readiness	Readiness Value Description
Highest	Suitable for wide-scale deployment when applied to the triples it supports.
High	A small number of minor issues. Suitable for wide-scale deployment when applied to the triples it supports, though issues exist which should be considered.
Moderate	One significant or several minor issues. Suitable for pilot deployments, but fails to provide sufficient interoperability, management, and security to enable proper, full-scale deployment.
Low	One serious or several significant issues. Not suitable for any deployment. Fails to provide even a base level of interoperability and security as recommended for pilot deployments.
Impractical	Many serious issues. Not suitable for any deployment. Standardization efforts not begun.

- Profiles –This lists the standards profiles that are used to carry out the communications of information in your project, or the characterize the data to be stored, distributed, and communicated with other systems. For each profile, the tables show the short name, the long name, type, the description of the profile, an editable comment, a checkbox of whether it is User Defined, and a checkbox of whether it is currently included in your project.
- P-Interconnects – This lists the physical interconnects from the physical view and their characteristics. You must have a Layer 0 or Layer 1 drawing in the Physical View for this to be populated.
- Standards – This lists the standards that are included in the ARC-IT database tables and have been assigned to a profile in your project. The table shows the name, the Standards Development Organization (SDO) that developed the standard, the Document number, the Document Title, a Description or abstract of the standard, and a checkbox indicating if the standard is user defined. Standards can be created in SET-IT in cases where the user

knows of a new or different standard that will be needed for a particular interface. You can add user defined standards to with the New Item menu.

- Standard Bundles – This lists groups of standards that combine to provide part of a data or communications profile.
- Assumptions and Constraints – This list is shared with the Physical view and lists things that the project implementers need to know – what is assumed to be true and needs to be factored into the development or what issues will constrain the development or operation in some way.

To add entries to one of the Communications tables described above go to New Item menu at the top of the screen to create a new Communications Profile, Data Profile, Standard, or Solution. You will be able to create a new user defined Issue from the Standards details form.

Review

SET-IT provides tools to Review your architecture, including a Spell Check tool and several Validation reports and a Flow Validation tool.

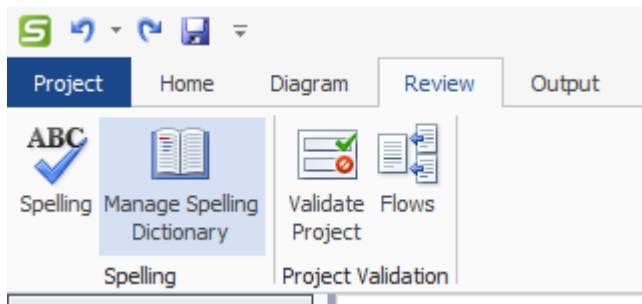

Spell Check

SET-IT includes a Spell Check utility to review all user defined items in your architecture including elements and stakeholders. From the Review menu select the **Spelling** Button and SET-IT will analyze all of the information contained in the database and open a Spelling Errors window. This Spelling Errors window shows all of the objects, elements, flows, and other architecture components that have a spelling error of some sort.

Field(s) Containing Errors	Type	User Defined	Name	Spelling Errors
Description	Element	<input checked="" type="checkbox"/>	MC Freeway Management Center	MCDOT has deployed two compute
Description	Element	<input checked="" type="checkbox"/>	MC Freeway Operators	Marinara County Department of Tr
Description	Element	<input checked="" type="checkbox"/>	Security Credentials Management	The Security Credentials Managem
Description	Service Package Instance	<input type="checkbox"/>	Asset Tracking Based Infrastructure	MC10 includes the capability to not
Description	Service Package Instance	<input type="checkbox"/>	C-ITS Based Monitoring	Communicate with cooperative veh
Description	Service Package Instance	<input type="checkbox"/>	C-ITS Based Monitoring	Communicate with cooperative veh
Description	Service Package Instance	<input type="checkbox"/>	C-ITS Communications	Use CVRSE field equipment to colle
Description	Service Package Instance	<input type="checkbox"/>	C-ITS Queue Warning	Short range communications suppo
Description	Service Package Instance	<input type="checkbox"/>	C-ITS Reduced Speed Warning	Short range communications provid
Description	Service Package Instance	<input type="checkbox"/>	Dynamic Ridesharing	Covers both implementations for d

Open one of the records by double-clicking on the fields and the Details form will open for that item.

Spelling errors are shown with a red line under them. SET-IT's Spell Check utility works like most Spelling applications. Once you see a spelling error right-click over the word and a menu will be shown with alternative spellings and options to ignore the error or add it to your local Dictionary.

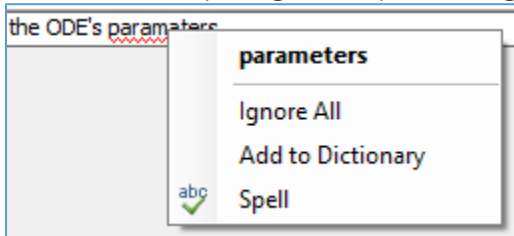

Clicking the "Spell" option opens a separate window for the Spelling application and provides additional detailed options as shown below:

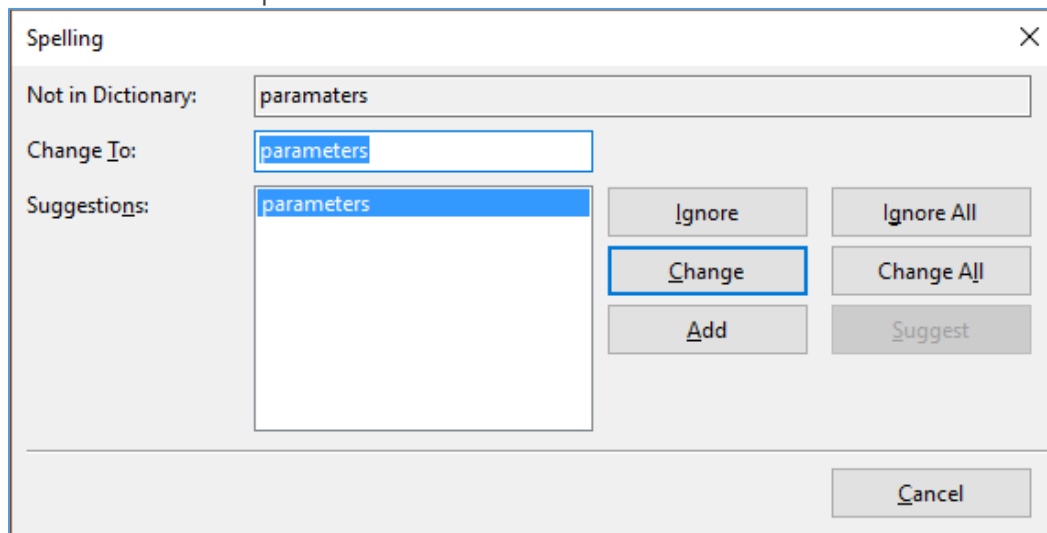

Note: The Spell Check utility that is running on all text fields will only highlight misspelled words that contain letters. If a word has a number in it Spell Check will ignore that.

Validation

In the Validation group there are 2 buttons: Validate Project and Flows.

The **Validate Project** button opens a window that allows you to decide what parts of your architecture to check for errors, consistency across the architecture, and items that need to be completed. This step is also called Validation.

There are different menu areas for each View of the architecture and a General area for general areas to look for during validation. Click the box for the view you are interested in and use the checkboxes to select what items to look for.

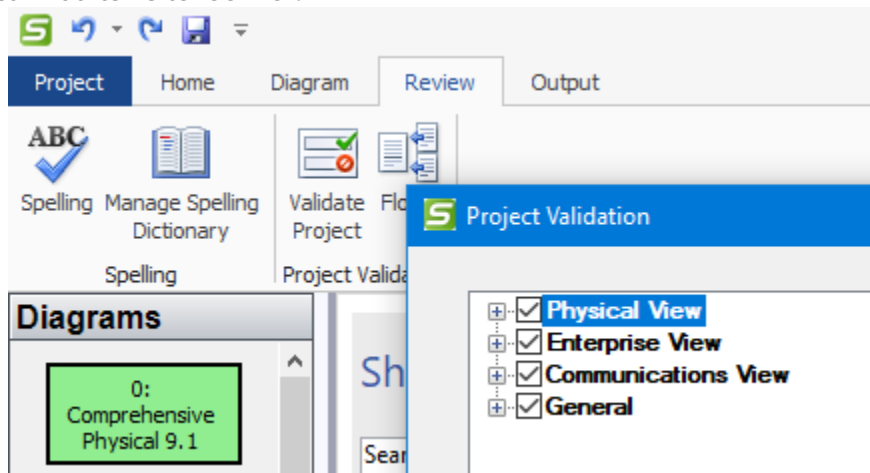

Physical View Validation Checks

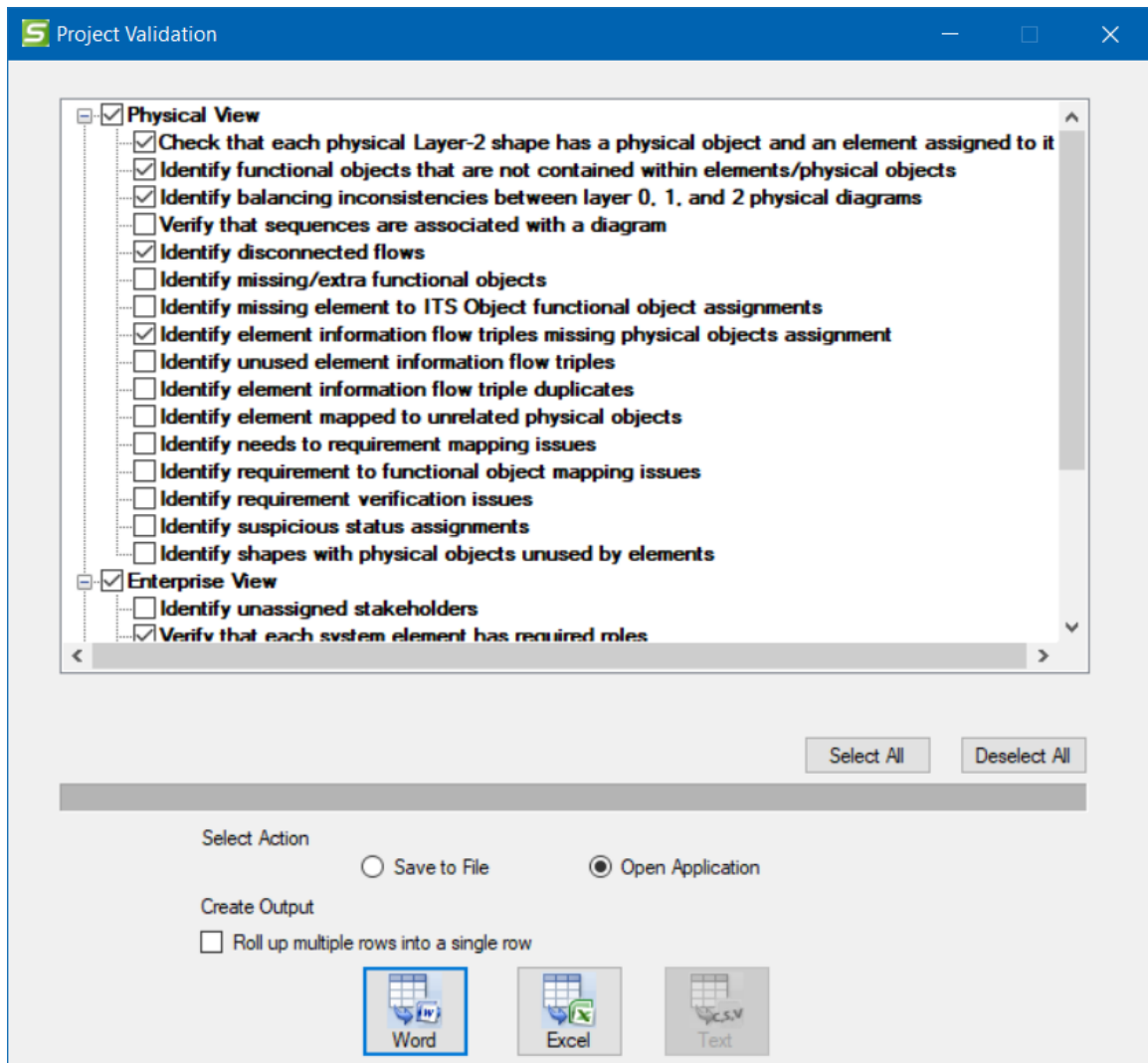

From the Physical View validation area, you can choose to run the following checks:

- Physical objects without element mappings (the connections between the generic ARC-IT physical objects and the local/project specific elements in your project)
- Functional objects that are not contained within elements/physical objects
- Balancing inconsistencies between Layers 0, 1, and 2 physical diagrams, such as flows that may have been deleted after you generated an upper layer diagram or interconnects that were disconnected on an upper layer diagram during the editing process
- Sequences that are not associated with at least one diagram
- Disconnected Flows (flows on a diagram that are not connected on one end or the other)
- Information flows with missing functional objects
- Missing element to ITS Object functional object assignments
 - Functional objects like “Management Support” and “Communications Support” are meant to provide the underlying functionality that applies to any subsystem PObject mapped ITS element in the project. This will indicate if those supporting functional assignments are missing and which diagram it appears. Consider including some of

the Support service packages in your project that will add these support functions to your elements for a complete view of how the systems in your project will serve their transportation needs as well as be supported from an information technology (IT) perspective.

- Element information flow triples that are missing physical object assignments
- Unused Element information flow triples – triples defined in the grid that do not appear on any diagram
- Element information flow triples that are duplicated on the same diagram
- Element mapped to an unrelated physical object (when a project is imported from RAD-IT that had an unusually complex mapping)
- Need to Requirement mappings issues – orphaned needs with no requirements traced to them or orphaned requirements that don't trace back to a least one need
- Requirement to Functional Object mapping issues – orphans, either requirements that do not trace to a functional object or functional objects without any requirements
- Requirement Verification issues – requirements that are missing a verification method
- Suspicious status assignments – flows where the status is out of sync with the source or destination
 - This would, for example, highlight flows where the status might be Existing but the source or destination elements is still Planned.
- Shapes with physical objects unused by elements - checks for shapes that have PObject mappings that do not correspond to any elements currently mapped to the shape. This helps identify situations where the user chose the no option to the prompt on the element update confirmation screen but never added any elements that map to the PObject they added to the shape.

Enterprise View Validation Checks

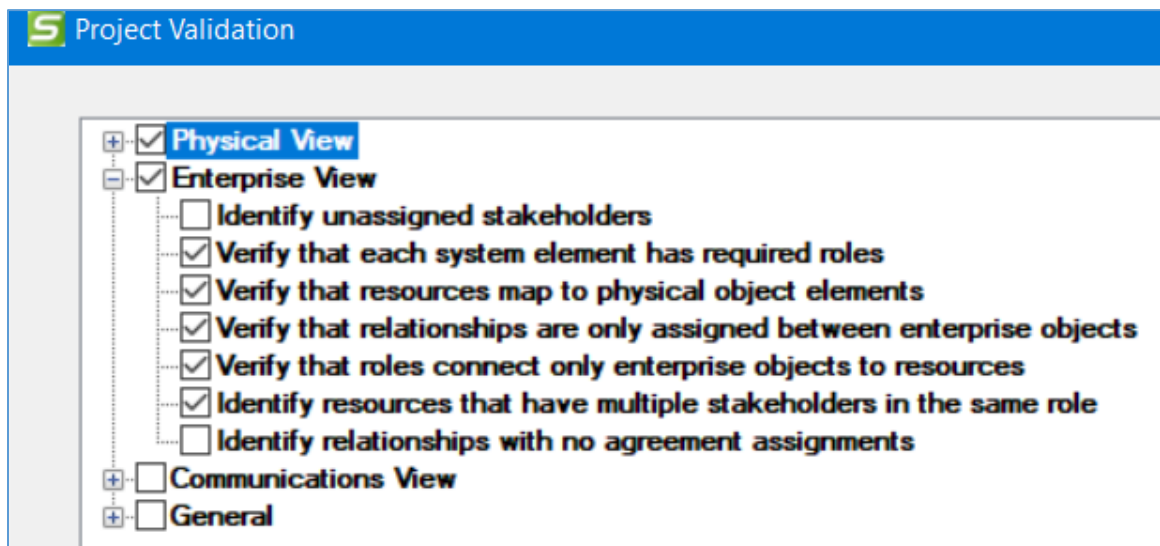

From the Enterprise View section you can choose to run the following checks:

- Unassigned stakeholders (stakeholders that have been defined but not assigned to any role with any of the elements)

- Check that each system element has the required roles (based on the Roles definitions grid in Enterprise View)
- Resources from the Enterprise view not mapped to physical object elements
 - In ARC-IT there is a relationship between resources in the enterprise view and the physical objects in the physical view. For a project architecture this means that your project's elements are really both Resources and Physical Objects. This report will make sure that's the case.
- Relationships that are between something other than enterprise objects
- Roles that are between something other than enterprise objects and their resources
- Resources that have multiple stakeholders that have the same role and status
- Relationships with no agreement assignments.
 - Recall that relationships are the un-customized enterprise agreements or expectations provided by ARC-IT. This determines whether the enterprise agreements that ARC-IT has match what agreements that are defined for your project and/or region that's implementing this project. The un-customized agreements or expectations show up on the enterprise drawing as italicized text with curly braces.

Communications View Validation Checks

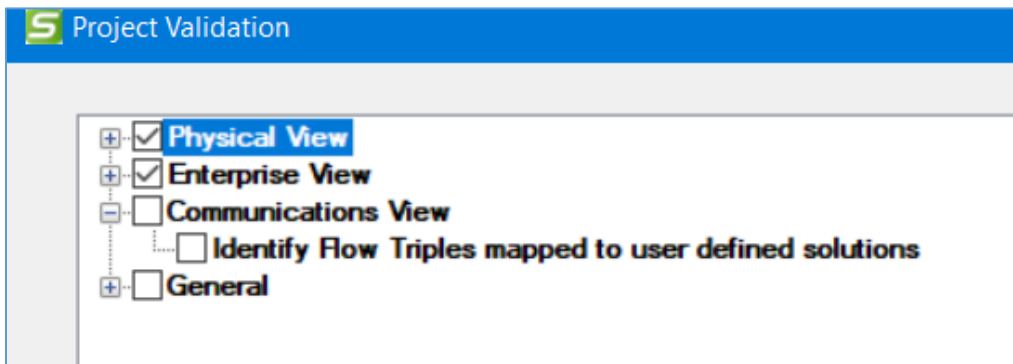

From the Communications View section you can choose to run the following check:

- Identify Flow Triples mapped to user defined solutions.

General Validation Checks

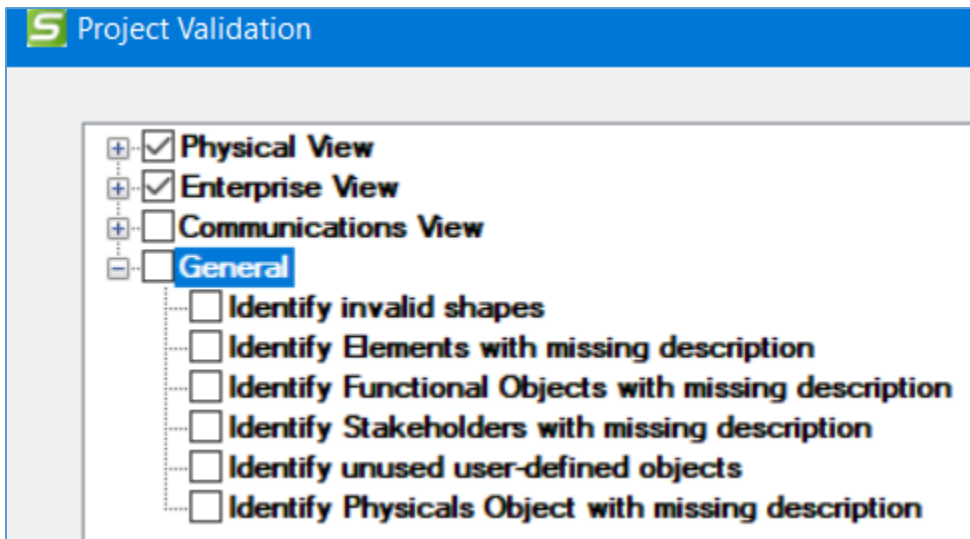

The General section lets you check for larger issues that may be spread across different architecture views.

- "Identify invalid shapes" checks the diagrams across all the views to see if something other than one of the shapes from the SET-IT stencil have been pasted onto a diagram.
- Elements with missing descriptions
- Functional Objects with missing descriptions
- Stakeholders with missing descriptions
- "Identify unused user defined objects" looks for user defined physical objects, elements, enterprises, agreements, flows, etc. that are not used on any diagram or connected in any way to any other part of the architecture.
- Physical Objects with missing descriptions

Use the Select All or Deselect All buttons as shortcuts.

Once the options are set, use the radio buttons to select whether to **Save** the results to a file (Word, Excel, or as a text file) or to **Open an Application** (Word or Excel) to view the results.

TIP: If you find yourself running the same validation reports over and over again then you can use the [Project / Options menu](#) and set the validation options you want to be your defaults.

TIP: if there is just one thing you want to check then be sure to click the "Deselect All" button first. Sometimes there are boxes checked on other tabs that you may not be aware of and will get a longer report than you expected.

Validate Flows Tool

During conversion Sync will look at the various information flow combinations. Architectures developed in previous versions may have had flows developed around the Element Triples – the

source and destination elements and the flow name. However, conversion may have increased the number of physical objects that element was assigned to. The sync process now needs to determine which combination of physical objects to use for that triple.

This is also available from the Review menubar.

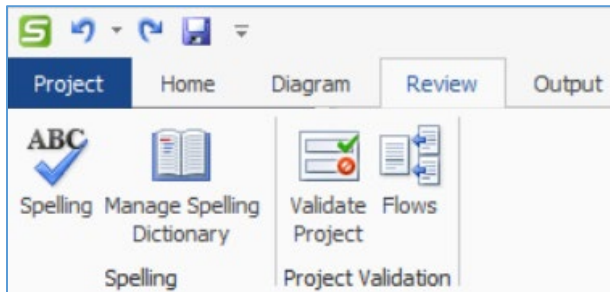

Click Review at the top of the menubar and 'Flows' in the Project Validation area to bring up the Element Flow Triples Review form below for complicated triple combinations.

You are directed to look through the list and double-click the combinations you don't want to see in your converted/synchronized architecture. Once you double-click a row it will show up as red to indicate that it will be removed from the database when you click 'Apply'.

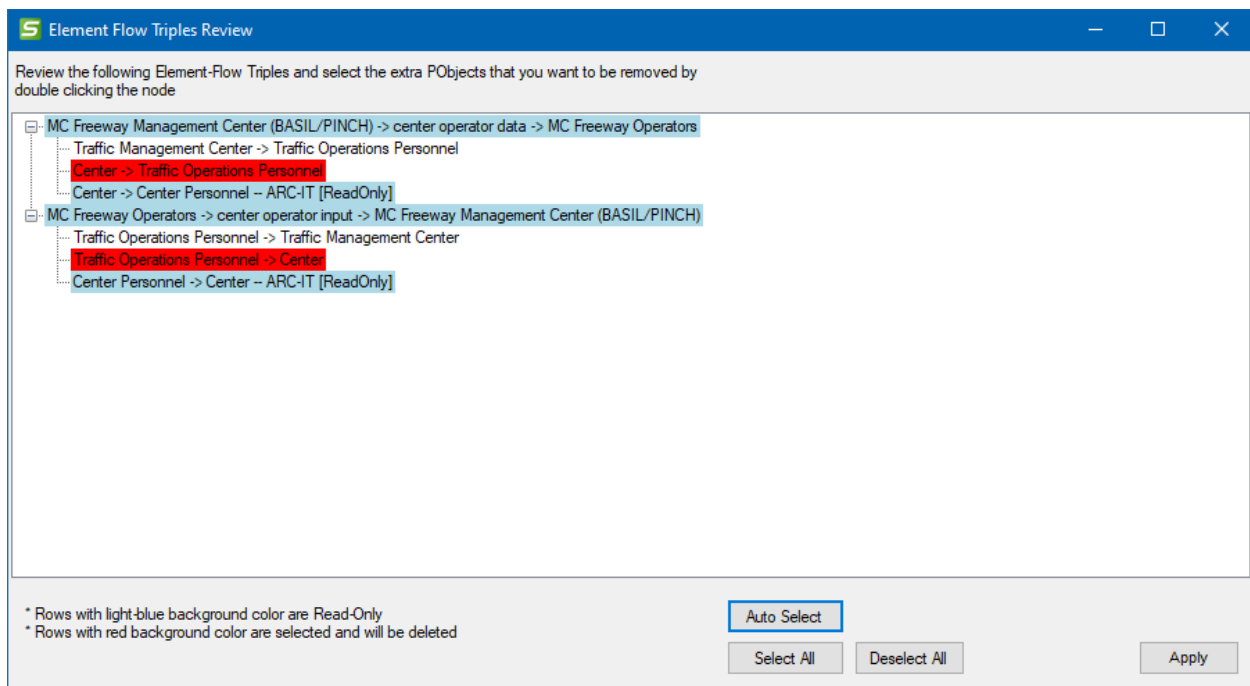

The Auto Select button will choose the combinations that are least likely – flows to or from the ITS Object or the generic 'Center' object, for instance. This will likely be a good thing to do, particularly for large complex architectures. Then you can review the red lines that were autoselected and use double-click the individual combinations further. There are also Select All and a Deselect All buttons if that helps.

When you done deciding which combinations to remove, click the Apply button. You will be asked if you are sure.

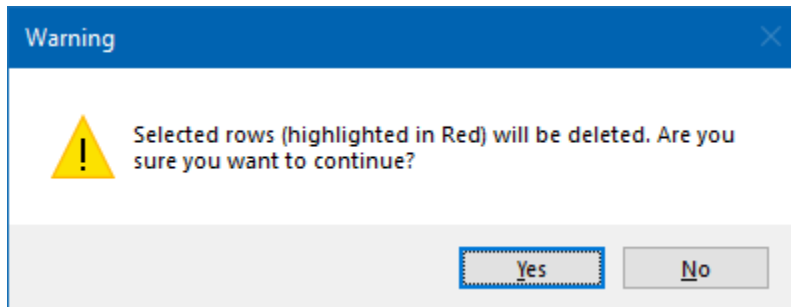

This tool is also part of the conversion process when a project is opened from a previous version.

Outputs

This section describes how to generate outputs using SET-IT to explain your project with Tables, Documents, and Diagrams.

If you are using a cloud-based or network-based storage system like OneDrive or Drop Box that try to synchronize your local files over a network then you may get a message that you have a "Locked File Selected" and "The selected file appears to already be open in another application. Please close the other application so SET-IT has exclusive access to the file." If this happens, you can still close SET-IT and your information is still stored. To avoid this message, go into the settings for the file sharing program, e.g., Drop Box, and pause synchronization until you are done generating the tables, documents, diagrams, or web pages.

Output Tables (Reports)

SET-IT includes tools to let you generate reports or outputs in tabular form that you can use to generate documents or presentations about your project.

From the Outputs tool bar, click **Tables** to bring up the **Output Tables** dialog.

Output Tables (Reports) Dialog Screen

Click the 1st pull-down to **Select Table**. You can scroll through the categories to find the report you want.

In the 2nd area select from the Available Columns which will vary depending on the table selected in the first step.

Use the left arrow to select individual columns to include (they will then move to the Selected Columns table). You can also use the double left arrow to include all the columns.

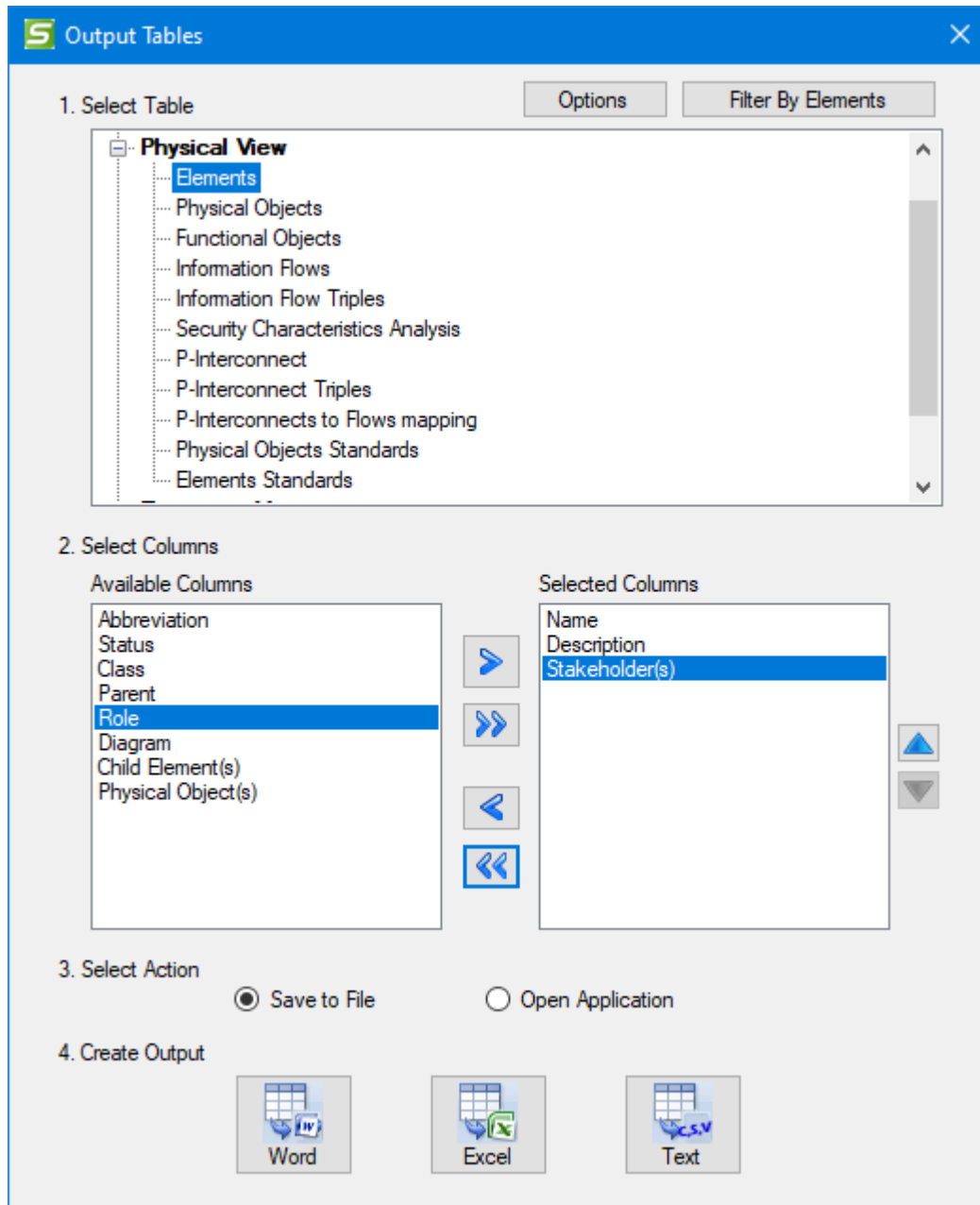

Select Action: you can simply Save the output to a File or choose to open the Application by selecting the appropriate radio button.

Create Output: here you can decide whether it should be in Word, Excel, or straight text format. Text, or Comma Separated Variable (CSV) format, would be useful if you were going to import the data into another type of application.

Output Tables Options

At the top of the Output Tables window is an "Options" button.

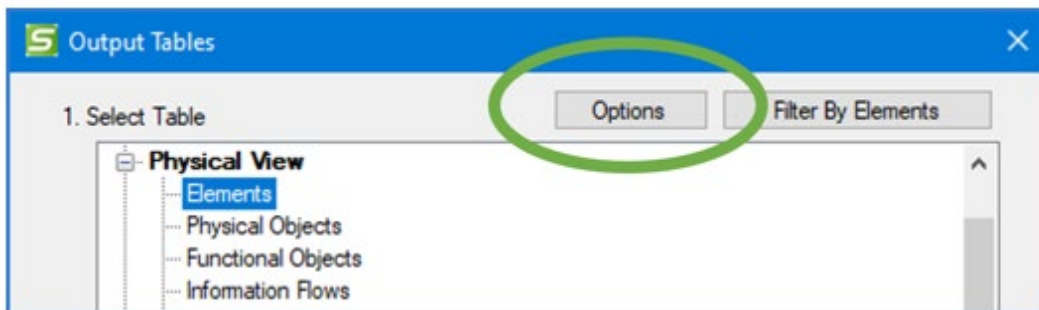

This opens the same options window available from the File / Options / Output menu.

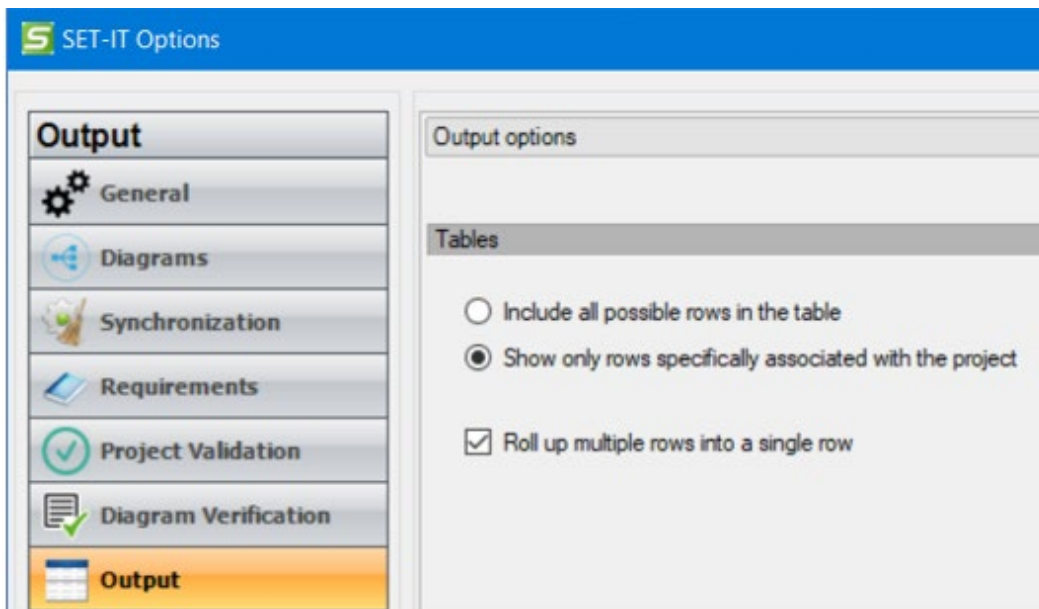

These options are used to change how the reports or Output tables will look, including:

1. A set of radio buttons to choose whether your tables include all possible rows from the database or only the rows specifically associated with your project.
TIP: You may not want to see data on all possible ARC-IT components so click "Show only rows specifically associated with the project".
2. A checkbox to roll up (or merge) identical data in multiple rows into a single cell.

Output Filter by Elements

Clicking the 'Filter by Elements' button at the top of the Output Tables screen changes the Output window.

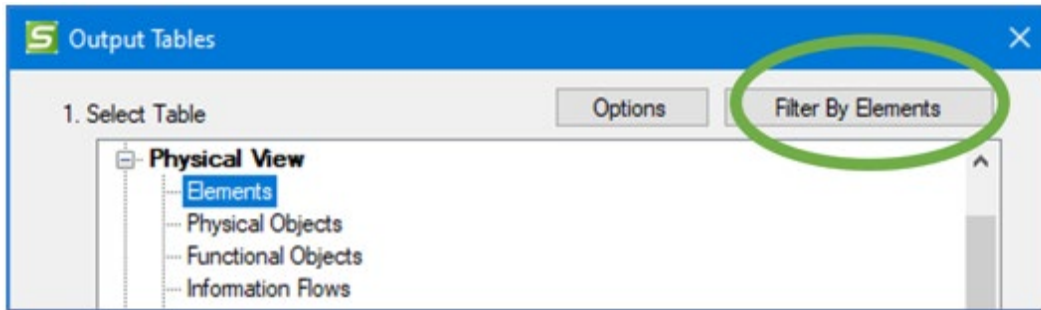

The Output Tables window expands to show the list of elements on the right of the screen.

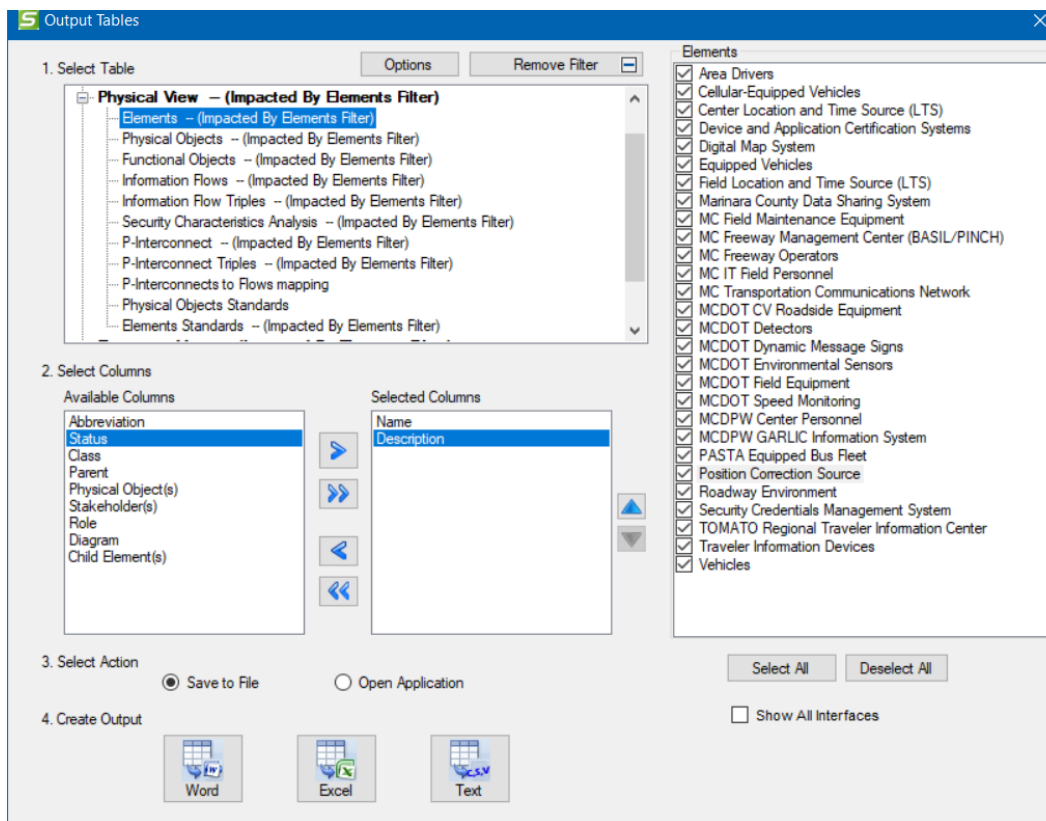

The Output Tables window expands to show the entire list of Elements in your project on the right of the screen. There are 2 buttons at the bottom: "Select All" and "Deselect All". There is also an option to Show All Interfaces. The left of the screen changed to visually show the user that the results of the outputs will be "Impacted by Elements Filter". The "Filter by Elements" button also changed to say "Remove Filter" so it acts like a toggle if the user no longer wants to filter by elements.

This allows you to select or deselect elements by which you may want to filter the outputs. For example, if you only wanted to see Information Flows associated with a single element, e.g. the Freeway Management Center, you would do the following:

1. Highlight the Information Flows output on the left
2. Click the "Filter by Elements" button at the top
3. Click the "Deselect All" button

4. Click just the checkbox for the Freeway Management Center
5. Click the "Show All Interfaces" button
6. Click to select the Available columns to include in the output
7. Click to Select Action – save to file or open the application

Click the Remove Filter to restore the outputs to include all possible elements.

Output Tables (Reports) – Current List of Reports

The following is the list of Tables that can be generated from the current version of SET-IT. Future releases of SET-IT will include more ways to generate outputs from your project file.

Project / File Info Outputs

The following is the list of tables describing the project or the SET-IT file:

- Project Summary
- Change Log
- Service Packages
- Diagram Information
- Status Values
- Stakeholders – including whether a stakeholder is a group and if so, what are its members
- Assumptions and Constraints

Needs & Requirements Outputs

The following is the list of tables describing the needs and requirements for the project:

- Need Areas
- Needs
- Requirements – including options to show the related Needs or the related Elements and Functional Objects the requirements trace to.

Physical View Outputs

The following is the list of tables describing the physical view for the project:

- Elements
- Physical Objects
- Functional Objects
- Information Flows
- Information Flow Triples (customized source, destination elements and the flows between them; use this to create tables sorted by service package instance, also)
- Security Characteristics Analysis (shows the Confidentiality, Integrity, and Availability (CIA) values and their rationale for the information flow triples in the architecture including the diagrams where the triple is used)
- P-Interconnects (Layer 0 or 1 physical interconnects between physical objects)
- P-Interconnect Triples

- P-Interconnects to Flows mapping
- Physical Objects Standards
- Elements Standards (the physical objects above that apply to your project's elements)

Enterprise View Outputs

The following is the list of tables describing the enterprise view for the project:

- Elements
- Enterprise Objects
- Stakeholders to Enterprise Objects
- Resources
- Roles
- Agreements
- Expectations
- Relationships (customized agreements, expectations, and other relationships that exist between stakeholders)

Communications View Outputs

The following is the list of tables describing the communications view for the project:

- Triple Solutions and Interface Readiness (for a given source/destination/flow triple and the selected communications solution, this shows the Computed Issue Severity which is the sum of the values of the issues associated with the triple solution, indicated as Lowest, Low, Moderate, High, Highest)
- Standards (lists only standards associated with an information flow triple through a solution in the project, also indicates a Bundle of which the standard may be a part)
- Standard Bundles
- Solutions to Standards
- Profiles to Standards
- Triple Solutions to Issues (issues mapped at the information flow triple and the solutions level. The ignore flag will indicate whether a particular issue has been set to be ignored by the readiness calculator for that issue.)
- Solutions to Issues (issues mapped to each solution in the project, see note above about the Ignore flag.)
- Available Solutions (all communications solutions available to the project)
- Available Profiles (all communications and data profiles available to the project)
- Available Standards (all standards available to the project)
- Available Solutions to Issues (see note above about the Ignore flag)
- Service Readiness (includes the overall readiness level and a list of issues for each service package instance and which information flow triples have that issue. It also indicates when a particular issue has been ignored on the Issues grid.)

Note: For the Communications View outputs Groups or Bundles of Standards will be broken out so the outputs will show all of the individual standards mapped to a profile or solution.

Scenarios

The following is the list of tables describing the operational scenarios defined for the project:

- Scenarios
- Sequences
- Sequence Steps

Output Documents

SET-IT includes tools to let you generate a complete document based on the information in SET-IT about your project.

From the Outputs tool bar, click **Documents** and choose from the list of documents.

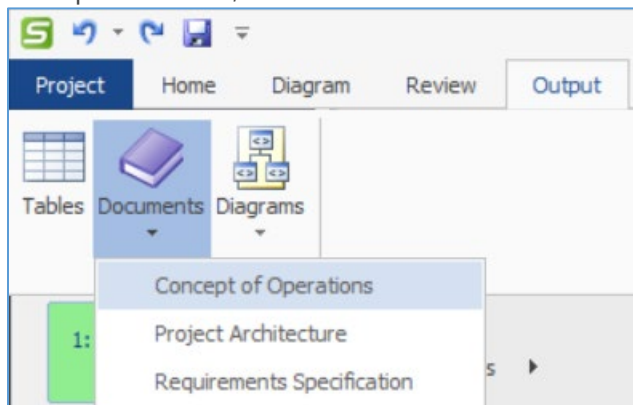

General document capabilities include the ability to Setup, Create, and View the document. The setup area allows you to establish general data for the document and edit the word template. A "Ready to Create" button can be used to see if there are parts of the template that will be used to generate your document that still need to be customized or established.

NOTE: Some users have reported a clipboard error when diagrams or documents are being generated. This happens when other programs running on the computer are also trying to access the Microsoft Windows Clipboard. If this happens, delete the diagrams affected and regenerate the diagrams. Try not to use Cut, Copy, or Paste on other programs while SET-IT is working on diagram/document generation. One other workaround to try is to go into the Windows Settings for the Clipboard and make sure the Clipboard History setting is 'Off' which prevents the clipboard from keeping other things that may interfere with SET-IT.

Concept of Operations Document Generation

A Concept of Operations document describes the current state of operations, establishes the reasons for change, and defines operations for the future in terms of functions/features and supporting operations. For connected vehicle projects a ConOps establishes the driving needs for the project, shows the high-level physical and enterprise architecture view in both diagrams and definitions based on ARC-IT, and a set of operational scenarios.

Notes sections are automatically included if you entered Notes into the fields on the Overview menus in either the Enterprise or Physical views. Enterprise view notes will be included in the enterprise portion of the System Description section and Physical view notes will be included in the physical portion of the System Description section.

SET-IT supports the generation of a ConOps with general and content specific setup choices.

The document setup screen for the ConOps is shown below:

The screenshot shows a window titled "Document Setup" with a blue header bar. It has two tabs: "General" and "Content". The "General" tab is selected. The window is divided into two main sections: "Document Setup" and "Title Page Information".

Document Setup Section:

- Folder:** C:\SETIT_Files\V2I Safety Initiative\ (with a "Browse" button)
- Document Filename:** ConOps.doc
- Document Template:** ConOps (ISO 29148) Template (with a dropdown arrow and an "Edit" button)
- Restore Template:** A button below the template dropdown.

Title Page Information Section:

- Use Template
- Title:** Concept of Operations
- Subtitle:** for the V2I Initiative
- Author(s):** Anne T Pazdough
- Organization:** Marinara County DOT
- Version:** 2.1
- Agency:** MCDOT
- Date:** 05/01/2024 12:00 AM (with a checked "Use Today's Date" checkbox)

At the bottom right, there are two buttons: "Ready to Create?" and "Close".

The document Setup window has 2 tabs: General and Content. The General tab has several features. The top area sets up the file information – folder location, filename, and the document template to

use. The bottom area sets up what will appear on the title page or in the version control page behind the title page.

On either tab, you can also select "Use Template" and the bottom fields will be greyed out.

The Edit Template button launches Microsoft Word file called a template (has a .dot file extension). A template file is used when you expect to use the same pattern on multiple documents. With SET-IT editing the template allows you to make changes to the template that will be used to generate the whole document. You can then let SET-IT save those changes for the next time you update the document.

Click on the Edit Template button when you have selected a particular section on the Content tab and Word will open the template and jump to that section.

There are 3 templates to choose from:

- ConOps (Ref Implementation) Template.dot
- ConOps (ISO 29148) Template.dot
- ConOps (Model Document) Template.dot

The first template is based on the Reference Implementation of the Connected Vehicle Reference Implementation Architecture that was developed for the testbed project in Southeast Michigan. The outline for that project started with IEEE Standard 1362 (superseded by ISO 29148) and then was customized to meet the needs of the project – some sections were moved around and some were omitted as not applicable.

The second is based on the base outline of the International Standards Organization (ISO) Standard 29148, which has superseded IEEE 1362, and is useful when contract requirements dictate that standard or anytime the needs of the project are different than the needs that were driving the reference implementation project.

A third template is available that is derived from the outline used for FHWA's Model Systems Engineering documents for ITS projects like Closed Circuit Television (CCTV), advanced signal control, and Dynamic Message Sign (DMS) deployments. This outline was based originally on the American National Standards Institute / American Institute of Aeronautics and Astronautics (ANSI/AIAA) G-043-1992 standard.

In all 3 templates, there are sections for you to provide background about the project and how the project will be developed and used in the future. The ConOps generated by either template will include diagrams and tables that are maintained in SET-IT.

Start with either template and customize it to suit your project's needs. Confer with your stakeholders and sponsors, first.

TIP: Use the **Edit Template** feature to develop your project specific content that the architecture views don't include, e.g., high-level background about the project. You don't want to wait until SET-IT is done to edit the document. That way SET-IT won't know how to

store extra information. By editing the *template* and then generating the document you can reuse that descriptive information and store it with the other definitions and your project diagrams.

The next tab on the Document Setup window is the Content tab as shown below (using the ISO 29148 outline):

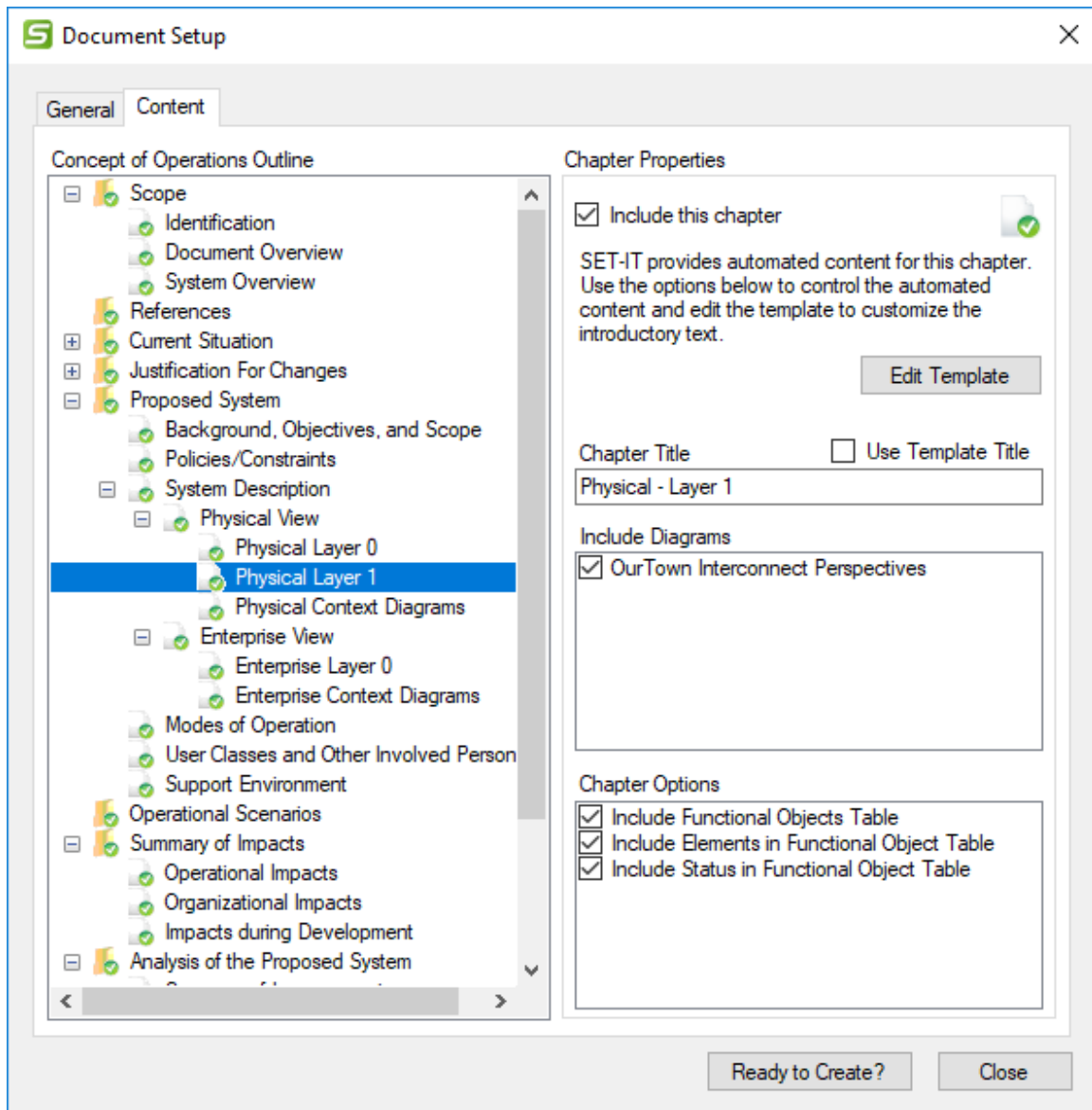

SET-IT is showing the outline discussed above and as you click on each section on the left side you will see some information about that section on the right.

You can also decide to exclude a section entirely by unchecking the box at the top. You can change the title of that section in the field shown on this screen or check the Use Template box and SET-IT will pick up the name as it's called in the word template you will edit.

There are several sections of the ConOps that have content that is stored in SET-IT, either diagrams or tables. For example, the Needs that are part of the justification for the new system are stored in the Needs table that was imported and edited in the Definitions menu's Needs grid. See the "Needs" section for more on the editing process. Now, when you are ready to include them in the document you can see that they are entered as a table. In the editing process you may have imported or created needs that were checked as "Info Only". An Info Only need is like a heading or just explanatory text rather than the text of a need for the system. When the document is generated it will look to see if there are any Info Only needs. If so, it will break up the Needs table and make the Info Only need entries be a table caption for that portion of the Needs. If there are multiple Info Only needs in a row then it will pull them out and make them look different with the last Info Only need being the table caption.

Any Info Only needs that are too long to be used as a table caption will just be pulled out as highlighted text. It is recommended that you will need to do some editing of your needs before and of the document after generation to get everything to look just right.

To include diagrams that you generated in SET-IT look at the System Description section of the outline and click on the type of diagram. For instance, click on Physical Layer 0 on the left and it will show you the diagram(s) in SET-IT to include in this section – use the check boxes to select which ones to copy into the document. It will also show the information that will be published in the form of tables and you can decide which ones to include or exclude. For the Context Diagrams there is an option to "Let me select an existing Visio drawing" which may be useful if you have previously generated context diagrams. This could shorten the overall document generation process.

NOTE: if an alias has been applied to a flow that alias will be shown on the diagrams instead of the original flow name. Use the Apply Alias check box on the Flow Details form or on the Information Flows Definitions grid.

SET-IT might say that there is nothing system generated about a section and that you should **edit the template** to write about it by replacing the paragraphs or statements that start with "{**" and end with "**}".

To Edit the Template, click the "Edit" button next to the Document Template box on the General tab or click the "Edit Template" on the Content tab.

Clicking "Edit Template" will open a word file called ConOpsTemplate.dot which is a word file used to be a template for other documents. You can edit and should edit this file to update the areas between the "{**" and "**}" marks. When you are done Save and exit word. Making changes in this way will allow you to be able to keep things that you have written while continuing to make changes to the architecture in SET-IT.

TIP: You may notice sometime that your ConOps Template (.dot) file opens as "Read-Only". This can happen if you had already generated a draft of your ConOps using the Create step (described below) and that document is still open. If that happens and you need to make

updates to the ConOps Template file, simply close both (or all) copies of Word that are open and go back to SET-IT and click the "Edit Template" button again.

One of the diagram types you can include is the Context Diagram. These are described in the Context Diagrams section below. Basically, for the Physical View, they allow you to take each element in the inventory of customized physical objects and it will draw a picture of all of the other elements with which it interfaces (information flows). Likewise, for Enterprise View, this feature will take each stakeholder and it will draw a picture of all of the other stakeholders with which it interacts (agreements, expectations).

To include Context Diagrams you now have a choice: you can select from existing diagrams or let the Document Generator create and insert new diagrams when you click the Create button.

The Context Diagrams portion of the Content setup screen for Context Diagrams is shown below:

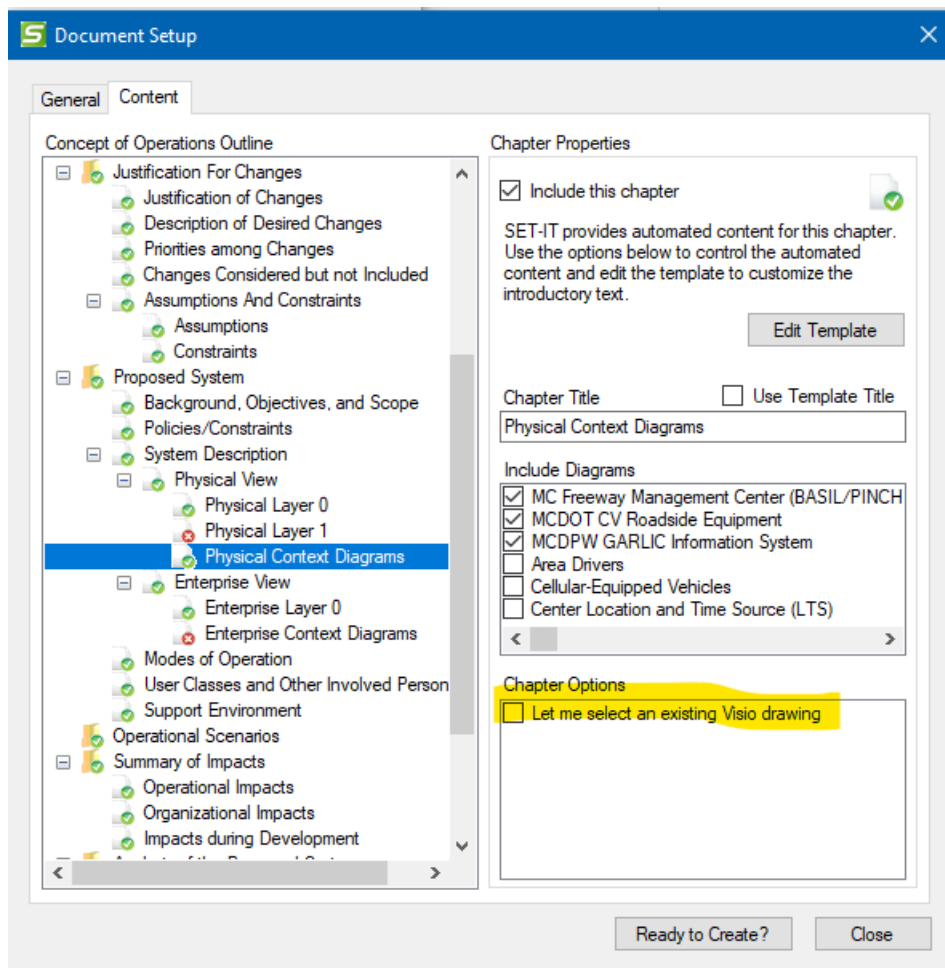

On the left side of the Content tab select the 'Physical Context Diagrams' section. On the right side of the Content tab select which diagrams to include and when the Create button is pushed it will regenerate the latest diagrams for those elements. With the "Include Diagrams" area you can decide for which elements to generate diagrams. For instance, you can decide to only include diagrams for

the major center systems in your ConOps. Any previously selected elements will be shown at the top of the list.

Alternatively, you can click the 'Let me select an existing Visio drawing,' and it will prompt you for the file location and name when it gets to that portion of the Document generation process.

This "Select an existing Visio drawing" box will save some time generating the document. If, on the other hand, you have made changes to your architecture and you haven't generated context diagrams recently, then un-check that box and it will process the diagrams, generate the diagram file, and include them in your ConOps.

You can also include Layer 0 or Layer 1 diagrams as part of your ConOps. Recall that Layer 0 diagrams have only the Physical Objects and their interconnects. Layer 1 diagrams add the functional objects. You can have more than one Layer 1 diagram.

NOTE: Sometimes the Layer 0 or Layer 1 diagrams are too large to fit on a page and may try and bleed into the next page. If this happens you can use Word to edit the output to make sure the diagram fits on a page. You may also be able to change the page size to accept a larger diagram – like an 11x17 fold-out page.

The **Operational Scenarios** section allows you to select the scenarios you created along with the sequence of steps. It will include the layer 2 physical diagram with the marked sequence steps showing and tables that list the steps along with their associated flows and objects, if applicable. Your ConOps can include one or more Scenarios. Each Scenario may include one or more sequences. Sometimes Scenarios may involve multiple service packages; for example, a System Support scenario might include sequences involve security credentials, object registration, and system monitoring. In those cases that scenario would have 3 sub-sections for each service package drawing with the sequence steps for each of those service packages shown.

After your document settings are setup on the General and the Content tabs you can press the "**Ready to Create?**" button to see if you really are ready. This will produce a To-Do-List Report in Word showing areas where the template hasn't been customized yet or that no diagrams are selected. It will also let you see where you have Scenarios or Sequences but haven't assigned any Sequence Steps to any of your diagrams. You can go back and edit the architecture, change the settings, and close this window.

Once you are ready then select **Create** – the progress window will show what it is doing and tell you when it is done. Then you can **View** that document in Word.

Note the cover page includes the title, subtitle, author, and other information from the Setup screen along with an icon indicating that this document was developed using SET-IT.

TIP: Use Save As to save a copy of the document and then as you make changes and add to your architecture you can regenerate the ConOps document without losing the earlier drafts.

NOTE: One issue that has reoccurred on a sporadic basis is an error that "Microsoft Word is not Available" when generating their ConOps. This may be due to an incompatibility between the version of Word and the versions of other Office products on the user's machine, e.g., Visio 2016 with Office 2010. You may need to zip the files and move to another computer to try the steps again or try updating the other Office products to be the same version.

MCDOT
Marinara County DOT

**Concept of Operations
FOR THE V2I INITIATIVE**

2.1
05/01/2024



Project Architecture Document Generation

A Project Architecture document can be used to provide a single output that contains the data and diagrams that describe your project using all of the information stored in SET-IT.

SET-IT supports the generation of a Project Architecture document with general and content specific setup choices.

The document setup screen for the Project Architecture document is shown below:

The screenshot shows the 'Document Setup' window with the following details:

- Document Setup Section:**
 - Folder: C:\SETIT_Files\V2I Safety Initiative
 - Document Filename: ArchDoc.doc
 - Document Template: ArchDoc Template
 - Buttons: Browse, Edit, Restore Template
- Title Page Information Section:**
 - Title: Architecture Document
 - Subtitle: A Description of the Project for V2I Safety
 - Author(s): Shouvelle & Tamp
 - Organization: Marinara County
 - Version: 92
 - Agency: MCDOT
 - Date: 05/01/2024
 - Use Today's Date:
 - Use Template:
- Bottom Buttons:** Ready to Create?, Close

The document Setup window has 2 tabs: General and Content. The General tab has several features. The top area sets up the file information – folder location, filename, and the document template to use. The bottom area sets up what will appear on the title page or in the version control page behind the title page.

On either tab, you can also select "Use Template" and the bottom fields will be greyed out.

The "Edit" button launches Microsoft Word file called a template (has a .dot file extension). A template file is used when you expect to use the same pattern on multiple documents. With SET-IT, editing the template allows you to make changes to the template that will be used to generate the whole document. You can then let SET-IT save those changes for the next time you update the document.

In the template, there are sections for you to provide background about the project and how the project will be developed and used in the future. The Project Architecture document generated by either template will include diagrams and tables that are maintained in SET-IT.

Start with the template and customize it to suit your project's needs.

TIP: Use the **Edit Template** feature to develop your project specific content that the architecture views don't include, e.g., high-level background about the project. You don't want to wait until SET-IT is done to edit the document. That way SET-IT won't know how to store extra information. By editing the *template* and then generating the document you can reuse that descriptive information and store it with the other definitions and your project diagrams.

The next tab on the Document Setup window is the Content tab as shown below:

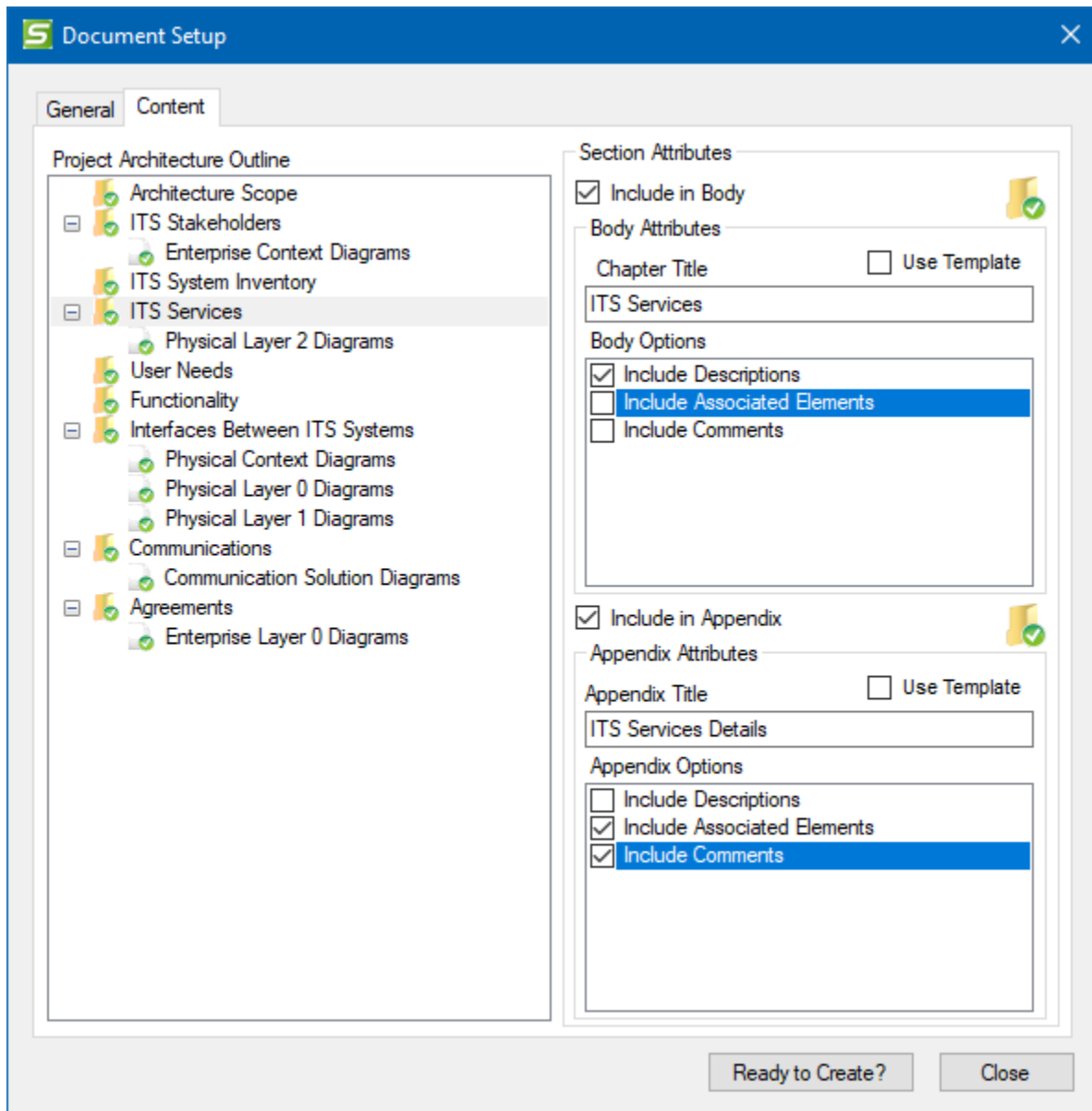

SET-IT is showing the outline of the document and as you click on each section on the left side you will see some information about that section on the right.

You can also decide to exclude a section entirely by unchecking the box at the top. You can change the title of that section in the Chapter Title field shown on this screen or check the Use Template box and SET-IT will pick up the name as it's called in the Word template you will edit.

Depending on the section there may be Options to include or exclude using the checkboxes on the right side of the Content Setup screen. You can also decide to include some information in the Body of the document and some information in the Appendix. It may make sense to include basic

information like the names and descriptions in the Body and the details like mappings to elements or diagrams for the appendices.

To include Context Diagrams you now have a choice: you can select from existing diagrams or let the Document Generator create and insert new diagrams when you click the Create button.

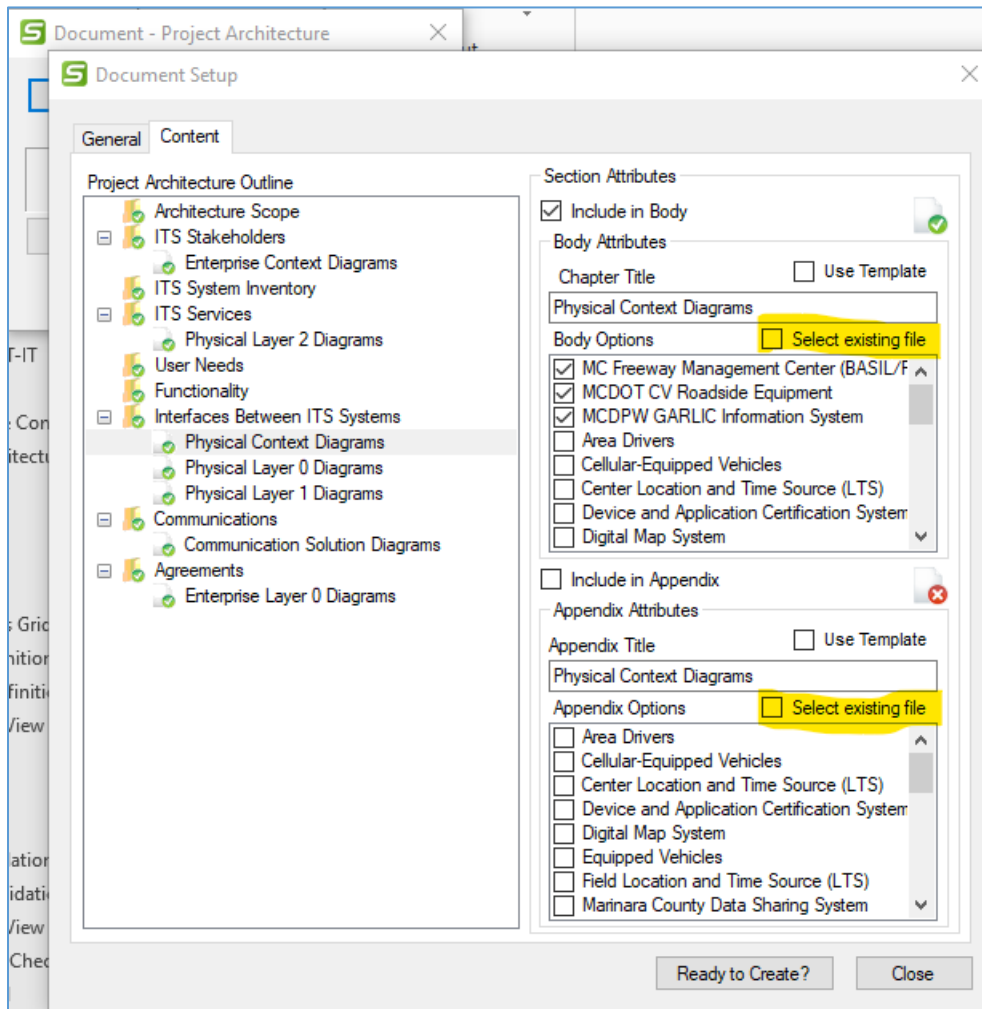

On the left side of the Content tab select the 'Physical Context Diagrams' section. On the right side of the Content tab select which diagrams to include and when the Create button is pushed it will regenerate the latest diagrams for those elements. Alternatively, you can click the 'Select existing file,' and it will prompt you for the file location and name of the Visio file when it gets to that portion of the Document generation process.

NOTE: if an alias has been applied to a flow that alias will be shown on the diagrams instead of the original flow name. Use the Apply Alias check box on the Flow Details form or on the Information Flows Definitions grid.

To Edit the Template, click the "Edit" button next to the Document Template box on the General tab or click the "Edit Template" on the Content tab.

Clicking "Edit Template" will open a word file called "ArchDoc Template.dot" which is a word file that is used as a template for other documents. You can and should edit this file to update the areas between the "{**}" and "**}" marks. When you are done save and exit Word. Making changes in this way will allow you to be able to keep things that you have written while continuing to make changes to the architecture in SET-IT.

TIP: You may notice sometime that your ArchDoc Template (.dot) file opens as "Read-Only". This can happen if you had already generated a draft of your project architecture document using the Create step (described below) and that document is still open. If that happens and you need to make updates to the ArchDoc Template file, simply close both (or all) copies of Word that are open and go back to SET-IT and click the "Edit Template" button again.

After your document settings are setup on the General and the Content tabs you can press the "**Ready to Create?**" button to see if you really are ready. This will produce a To-Do-List Report in Word showing areas where the template hasn't been customized yet or that no diagrams are selected. You can go back and change the settings and close this window.

Once you are ready then select **Create** – the progress window will show what it is doing and tell you when it is done. Then you can **View** that document in Word.

Note the cover page includes the title, subtitle, author, and other information from the Setup screen along with an icon indicating that this document was developed using SET-IT.

TIP: Use Save As to save a copy of the document with the date or a number of the draft and then as you make changes and add to your architecture you can regenerate the ConOps document without losing the earlier drafts.

Notes sections are automatically included if you entered Notes into the fields on the Overview menus in either the Enterprise, Physical, or Communications views. Enterprise view notes will be included in the ITS Stakeholders section. Physical view notes will be included in the ITS Services section and Communications view notes will be in the Communications section.

System Requirements Specification (SyRS) Document Generation

A System Requirements Specification (SyRS) document is used to provide a single output that contains the requirements that are to be fulfilled by the implementation of the system being described in this SET-IT project. In Systems Engineering, requirements drive the development effort. It is these 'shall' statements that will be the basis for verifying that the system was built correctly and is ready to be handed off to the user and/or agency responsible for the operation of the new system. The outline for this document is based on the International Standards Organization (ISO) Standards 29148.

SET-IT supports the generation of a SyRS with general and content specific setup choices.

The document General setup screen for the SyRS is shown below:

S Document Setup [X]

General | Content

Document Setup

Folder: C:\SETIT\V2\ Safety Initiative [Browse]

Document Filename: SyRS

Document Template: SyRS (ISO 29148) Template [Edit]

Restore Template

Use Template

Title Page Information

Title: System Requirements Specification	Subtitle: SyRS for Vehicle to Infrastructure Safety Initiative
Author(s): Butch R Block (KCC)	Organization: KCC
Version: 9.1	Agency: Marinara County DOT
Date: 6/1/2022 <input type="checkbox"/> Use Today's Date	

Ready to Create? Close

The document Content screen for the SyRS is shown below:

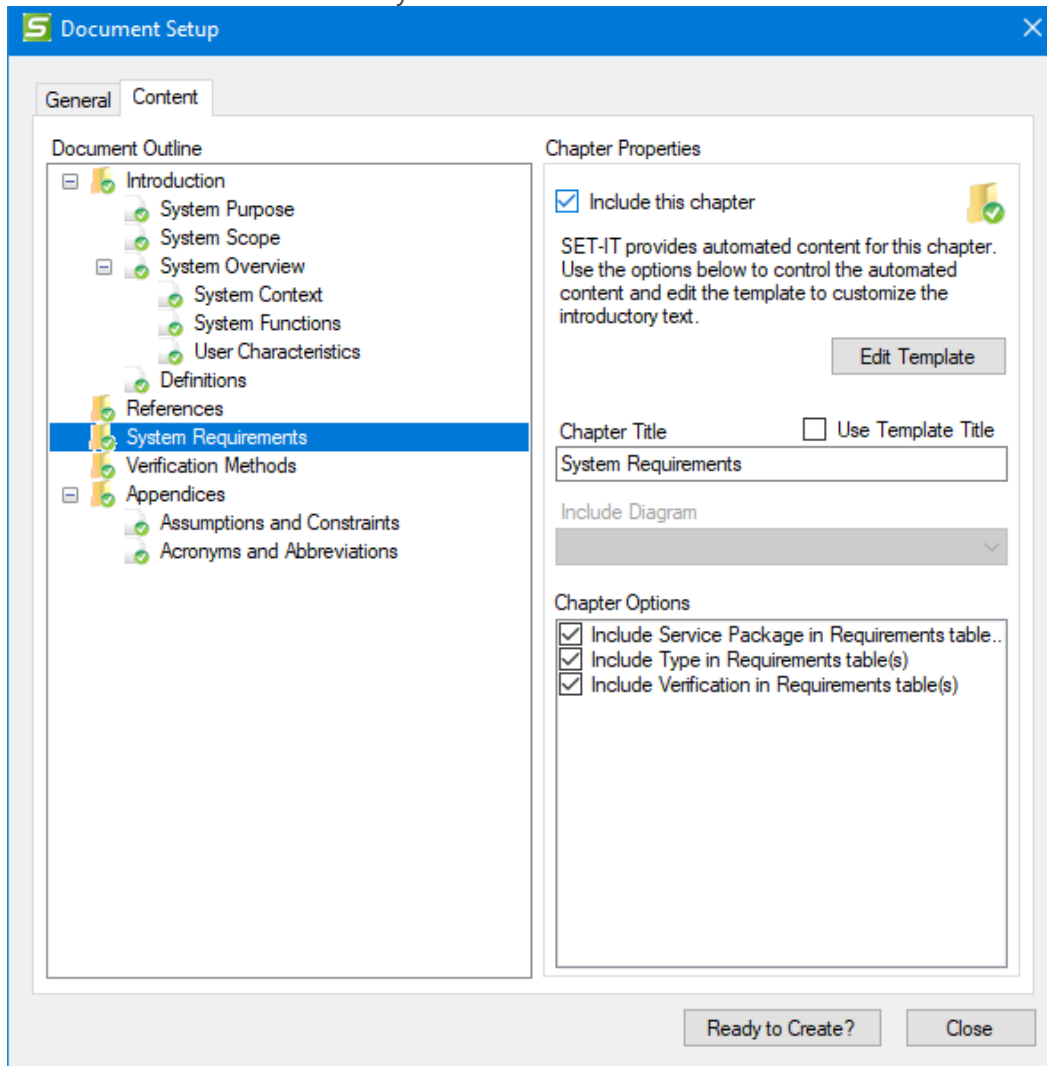

The key section for a Requirements Specification is, of course, the System Requirements section. Note there are options here on whether to include the Type of requirement in the tables and whether to include the Verification method in the tables of requirements. If you are in 'system' mode based on the Project / Options / Requirements menu screen then you will see an additional option here on the document setup screen to choose whether or not to include the Service Package in the Requirements table. It will be defaulted to yes.

The document generator will look through the requirements definitions table to see if there are any requirements that have Info Only checked. If there are then it will use those to break up the table into sections of requirements.

The document generator will also look to see if you had set your options (see *Requirements Options*) to use System level requirements or to allocate requirements to each element. If you selected Element mode, then it will break up the requirements section into a separate table for each element.

As with the ConOps and the Project Architecture document the template can be edited and should be to ensure that the content reflects what is needed for this project. Use the same process as described to edit the ConOps template. Once the template is saved it will stay with the project and any updates to the database of requirements will be reflected in the SyRS the next time you generate the document.

Output Diagrams

SET-IT provides tools to create a set of diagrams in addition to the service package-focused views that ARC-IT provided. These can be either Interface Diagrams that show the information flows between selected pairs of elements, Context Diagrams that put a selected element in the middle and show the information flows that go to or from that element, or Communications Diagrams that show the Communications Solutions for the information flows in your architecture.

Interface Diagrams

Interface Diagrams show the information flows between selected pairs of elements. These can be very useful when developing a project architecture and you need to settle on the specific information exchanges between 2 system elements, particularly between systems owned by different stakeholders or that will require certain standards to be applied. Once you select the elements for which you want to generate diagrams, SET-IT will then generate a separate Visio file with the diagrams that can then be printed or imported into other outputs, e.g., interface specifications or presentations.

From the Output Ribbon, click Diagrams and Interface Diagrams.

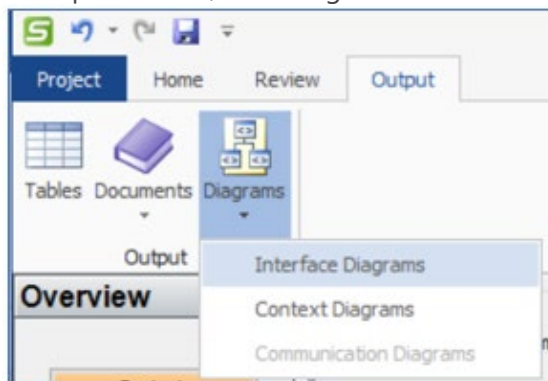

On the Interface Diagrams screen, the list of elements from your inventory will be shown on the left of the screen. As you click the name of the elements (one at a time) the right side of the screen will show you the list of elements with which the left element interfaces.

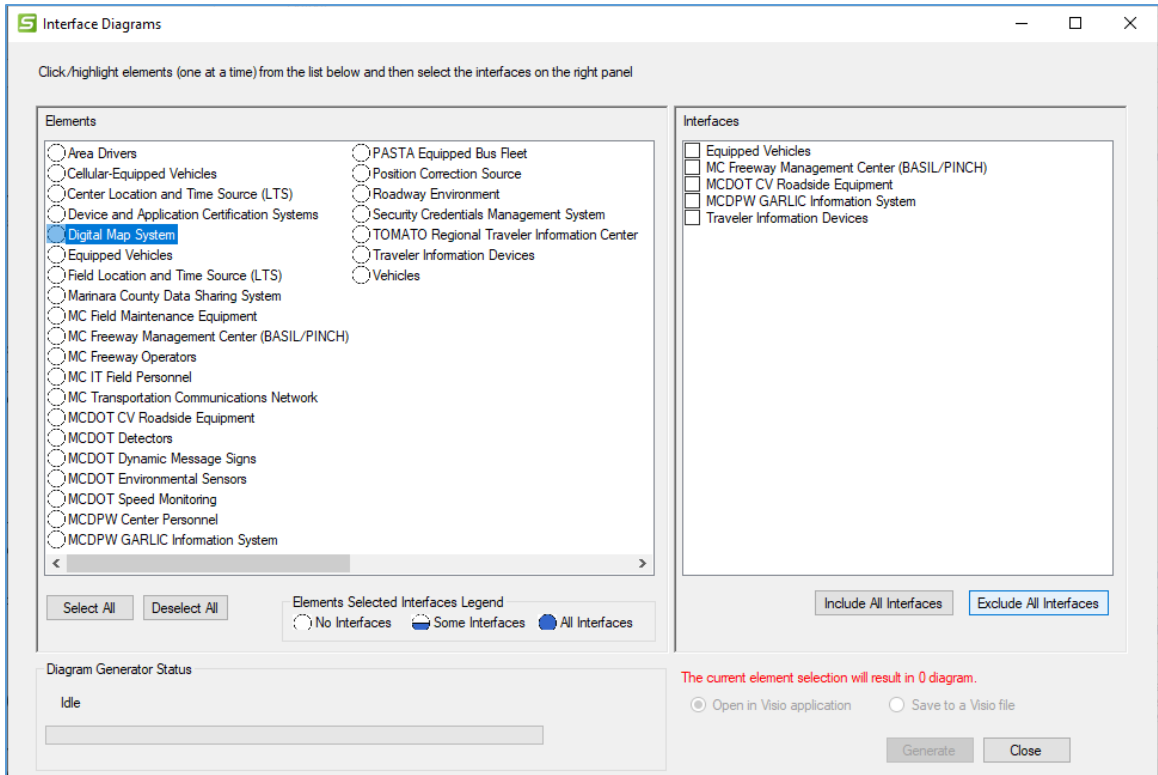

In the example shown above, the user has opened the Interface Diagrams window and clicked to highlight one of the elements – Digital Map System. On the right side there are 5 elements listed that interface with the Digital Map System in some way.

The next step is to then click the check boxes for each inventory element that you want to see a diagram for. So, for instance, after clicking to highlight Digital Map System you see that it interfaces with Equipped Vehicles, the TMC, CV Roadside Equipment, the Maintenance center, and traveler information devices. The next step is to click one or more of those elements on the right.

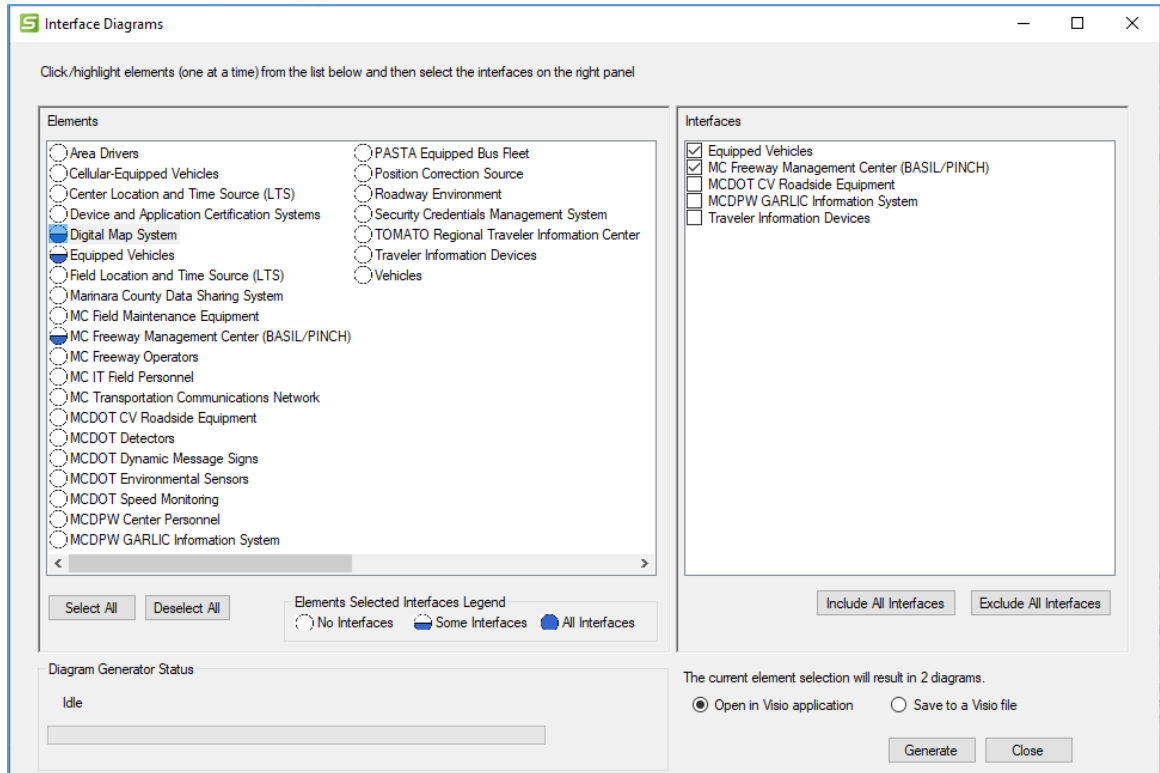

A message at the bottom right of the screen will let you know if your selections will not result in any diagrams, i.e. if you pick 2 elements that don't interact. It will also change to show you how many diagrams will be drawn. This could help you decide if you want to run it multiple times with fewer diagrams each time. The more element combinations selected the more CPU, memory, and time will be needed.

After picking one or more elements on the left and then as you click elements on the right you will see the icons change. The circles beside the elements on the left will fill in as you select elements:

- Blank circle means no interface diagrams for that element will be drawn
- Partially filled circle means some interface diagrams for that element will be drawn
- Completely filled circle means that all of the diagrams for that element will be drawn

Buttons on the left to "Select All" or "Deselect All" and buttons on the right to "Include All Interfaces" or "Exclude All Interfaces" help you with your selection process.

You can choose to "Open in Visio application" or to just "Save to a Visio file".

Next click the "Generate" button and it will create a Visio file with a tab for each pairing of elements.

If you clicked Open then it will launch Visio to show the diagrams it has generated.

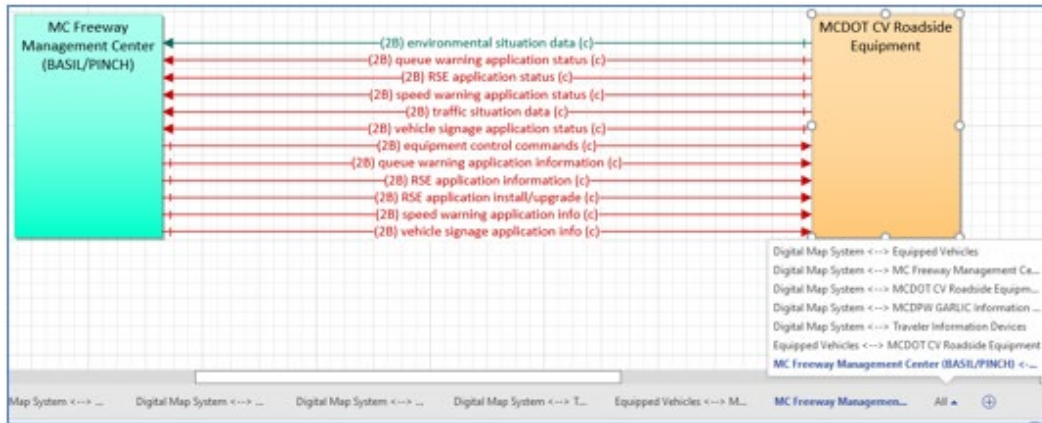

You can save this Visio file for later use. You can also select to just use the “Save to a Visio file” option and it will create and save the file in the project folder.

NOTE: if an alias has been applied to a flow that alias will be shown on the diagram instead of the original flow name. Use the Apply Alias check box on the Flow Details form or on the Information Flows Definitions grid. If two flows have the same alias, they are reduced to one flow in this diagram output.

TIP: If you notice that it is taking a lot of your system resources (CPU, Memory) or just a long time to generate the diagrams then consider breaking it up and selecting subsets of the diagrams you need and create separate files.

Context Diagrams

Context Diagrams focus on one element/resource or stakeholder at a time and then draw the interfaces or relationships that go into or out of that one element of stakeholder. These are good for guiding conversations with stakeholders so they can see their system in the middle and all the inputs and outputs their system will be responsible for. This provides a way that they can gain an understanding of how they fit in the overall scheme of the project.

From the Output Ribbon, click Diagrams and Context Diagrams.

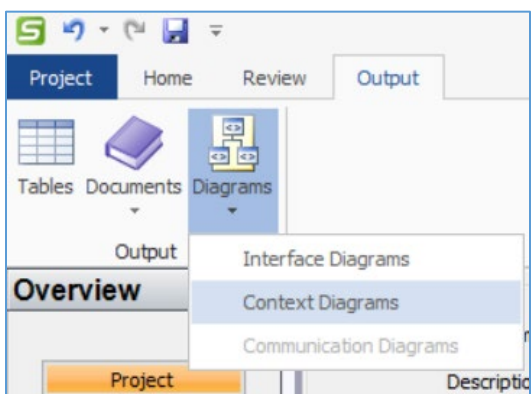

Another window will open that is similar to the Interface Diagrams generation window.

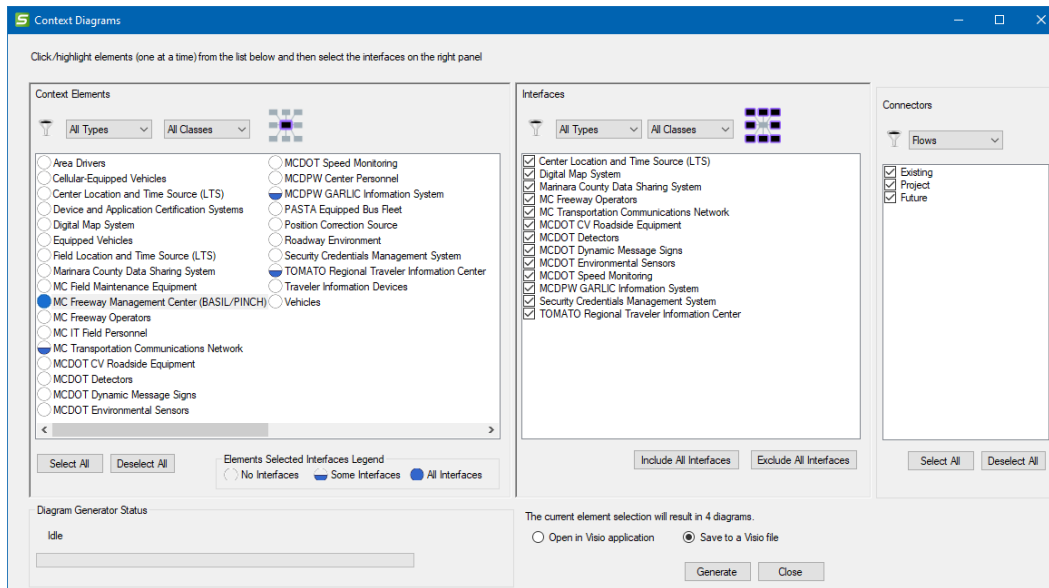

There are 3 areas on the Physical/Enterprise Context Diagram Setup window corresponding to 3 basic steps:

1. **Elements (or Context Stakeholders for Enterprise view)**– provides a listing of all of the Elements in your architecture or Stakeholders when in the Enterprise view. Select which ones to include in your output. In the physical view use the pull-downs to filter the Types (System or Human) or Class (Center, Field, Personal, Support, or Vehicle). You can also click Select All or Deselect All as a short-cut.
2. **Interfaces (or Coordinations in Enterprise)**– provides another list of Elements (Physical Objects) or Stakeholders (Enterprise Objects) that you want to include around the element of focus. For instance, there may only be a small set of elements that you need to focus on – the primary systems in your project or region. You can also use the Type and Class pull-downs to filter the selections.
3. **Connectors** – provides a pull-down to select the type of connections to show: Flows (layer 2) or Physical Interconnects (layer 0 or 1). In the Enterprise view you can select between Agreements and/or Expectations. In either view you can also decide which Status Values – all, existing, project, new opportunities, etc. – to include perhaps to show separate diagrams for before and after your new system is installed.

Notice on the left that as you make selections in the middle and right of the screen that the buttons beside each Element or Stakeholder will fill-in to indicate that some or all of the interfaces or coordinations for that element or stakeholder are going to be generated.

There will also be a message that says how many diagrams will be generated to give you some idea of how long it will take or how involved the process will be. It may also tell you that there will be no diagrams generated which can indicate that you need to redo some of the filtering selections. For instance, maybe there are no 'Future' interfaces surrounding one of the elements. Go back up and

change the status to Existing or Project to see if it changes. This can be a tool to help you debug issues in your project, too.

At the bottom, select whether to save the output directly into a Visio file or to open it up and display the results in Visio. Press **Generate** and SET-IT will build a new drawing file that has a diagram for each physical element or enterprise stakeholder selected in the left column of the setup screen.

During the creation of the diagrams if you click the **Cancel** button, it will cancel the diagram creation. This is useful if you have a lot of diagrams but remember that you needed to edit something first. It will stop the process and you can come back and change the selections and hit Generate again.

NOTE: if the element in the middle happens to be a communications type element, then the context diagram will show the flows that pass through the communications element. So, for each triple that uses a particular communications element, that communications element's context diagram should show two lines: one from the source to the communications element, and one from the communications element to the destination.

Flows on context diagrams for the non-communications elements that make use of communications or DDS elements will show the flow name on the context diagram with the (c) or (d) or both, as appropriate to the individual flow.

NOTE: if an alias has been applied to a flow that alias will be shown on the diagram instead of the original flow name. Use the Apply Alias check box on the Flow Details form or on the Information Flows Definitions grid. If two flows have the same alias, they are reduced to one flow in this diagram output.

Communications Diagrams

The next type of diagram that can be created and output with SET-IT is the Communications Diagrams when you are in the Communications View.

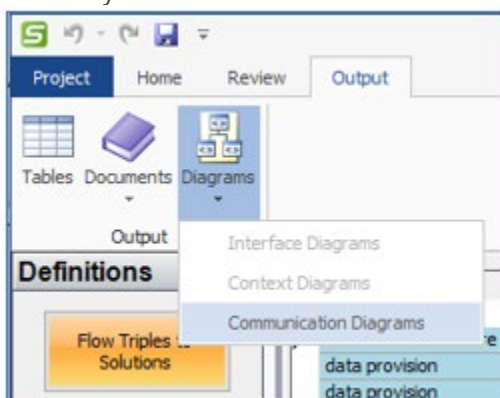

The Communications Diagrams feature works similarly to the Document generator with a Setup, Create, and Preview/View window:

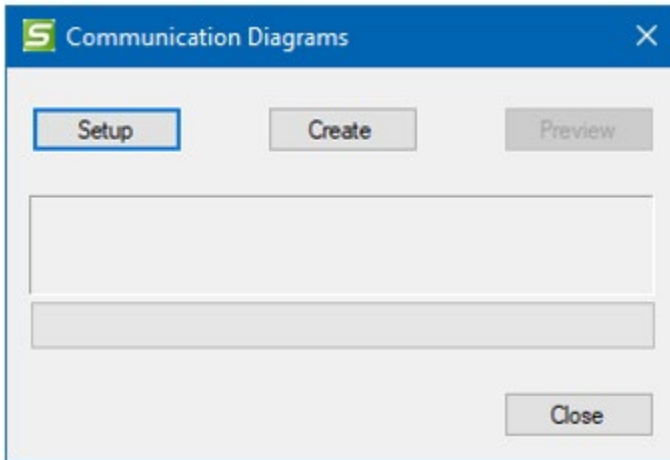

Press the "Setup" button to see the list of interfaces (information flow triples from the Physical View) and the Communications Solution that has been selected in the Communications View for that triple.

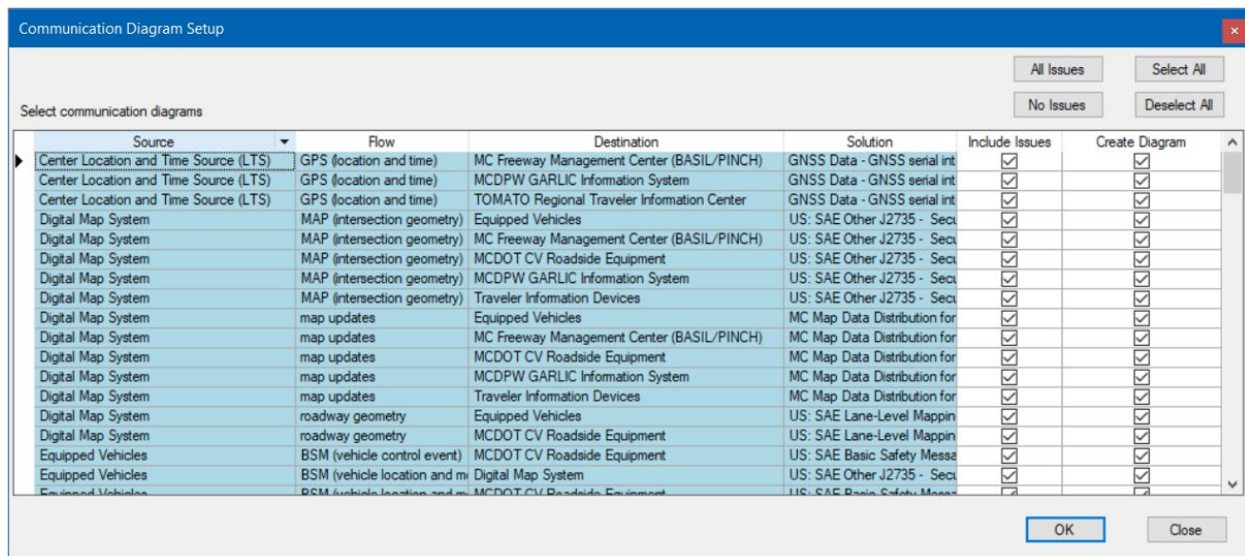

Use the check boxes on the right to pick which interfaces you want to see drawn. You can also use the Select All or Deselect All buttons as short cuts.

The "Include Issues" column let's you decide if you want to include the gaps and issues associated with the communications solutions (or their standards or profiles) directly on the communications solutions diagrams. If you check the box, you will see them in a list directly below the communications protocol diagram. You can use the "All Issues" or "No Issues" boxes to check/un-check all of the cells in that column at once as a short cut.

The Setup window is a good opportunity to see if you agree with the way things have been developed in your project architecture so far. For instance, there may be interfaces you expected to see that are missing or that the names don't look right. Now is the time to go back to the Physical view and make changes – either in the diagrams or in the definitions menus – or to the Communications view and adjust the solution chosen.

NOTE: if an alias has been applied to a flow that alias will be shown on the list with the original flow name in parentheses. Use the Apply Alias check box on the Flow Details form or on the Information Flows Definitions grid. If two flows have the same alias, they are reduced to one flow in this diagram output.

Once you are satisfied with the selected diagrams, close this window with OK or Close button.

Now press the Create button to start the process. The progress bar will update as each of the diagrams is being created.

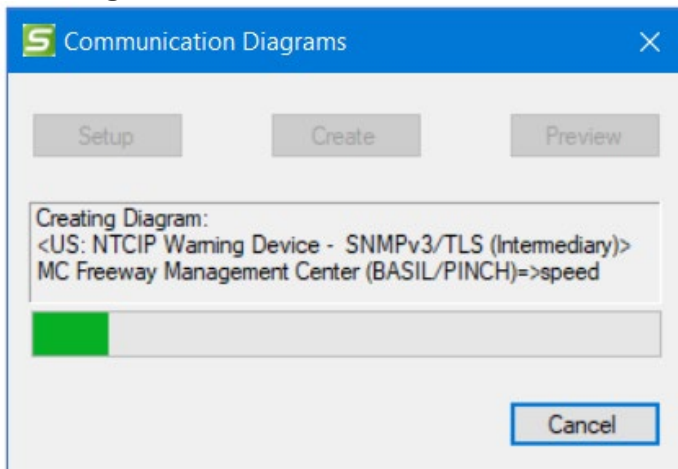

Once the process is complete it will say it succeeded and you can click Preview.

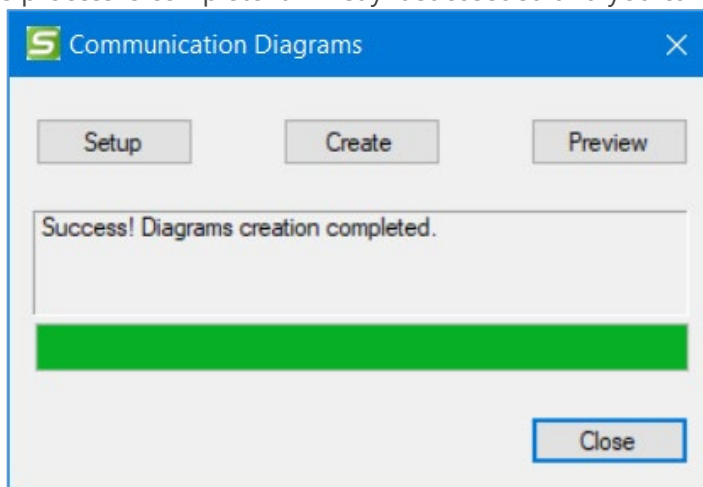

When it is done the Preview button will be highlighted. The Preview screen shows the list of diagrams on the left and a preview snapshot of what the diagram looks like.

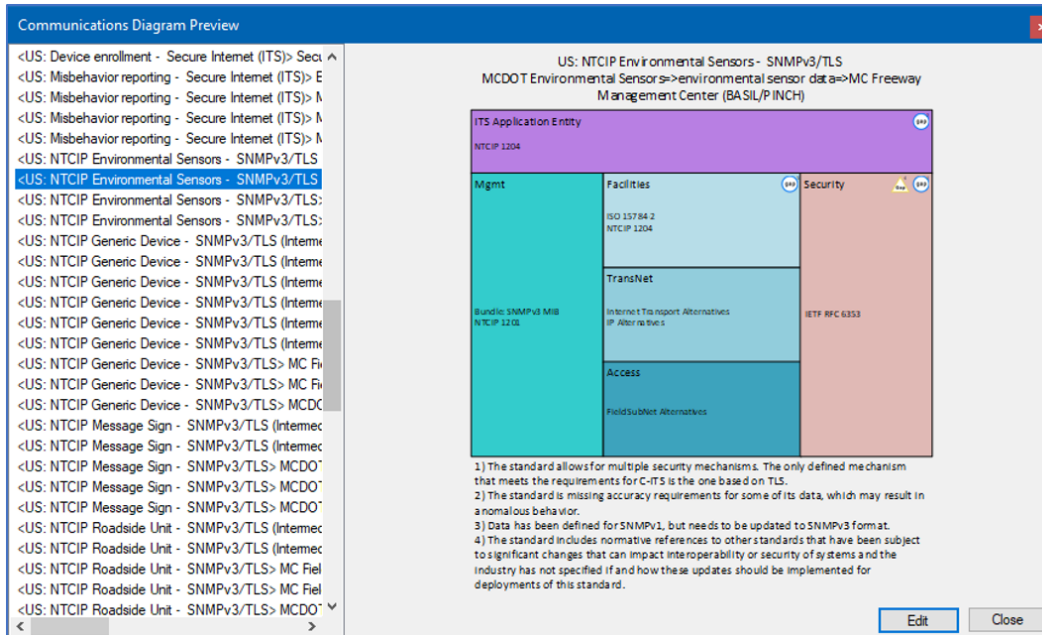

You can click Edit to open the diagram in Visio or click Close to close this window.

If you would like to edit the diagrams at this point you can click Edit to launch a copy of Visio. Visio will launch with the set of diagrams just created in a separate file. It is a good idea if you envision making changes directly to the Visio drawings to save the file off into a separate location so that the next time you use SET-IT to generate the Comm diagrams it won't write over your changes.

SET-IT creates separate drawing, shown as a separate tab in Visio, for each Information Flow Triple. The top of the diagram shows the name of the Communications Solution and the name of the information flow triple (with source, flow name, and destination). The color coding matches the coloring of the components of the Communications View from ARC-IT. In each box you see the standards associated with that layer or component and there may be one or more icons representing gaps or issues with the standards associated with that solution. The superscript number above each of the Gap icons will point to the issue description like a footnote.

Below the figure you will see the issue descriptions that are represented by the icons in the figure.

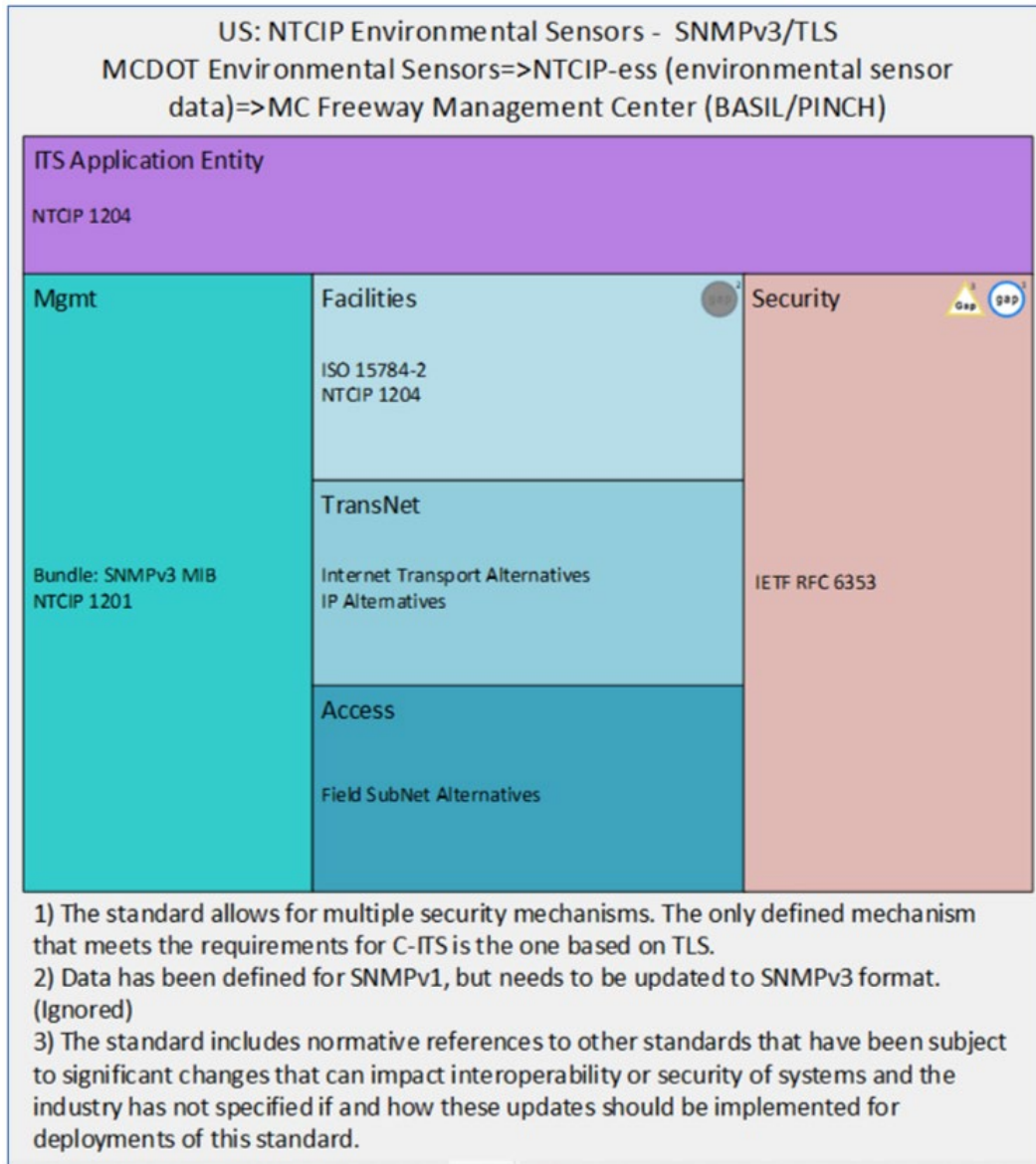

If the Ignore flag was set for an issue on the Issues table then that will be reflected in 2 ways on the diagram. The gap icon will be shown with a greyed out effect and the word "(Ignored)" will be written at the end of that issue.

If changes are needed to the mappings go back to the Communications View Definitions to update the mappings and other information, then regenerate the diagrams.